

# TROCARS & SUCTION TUBES

# 06

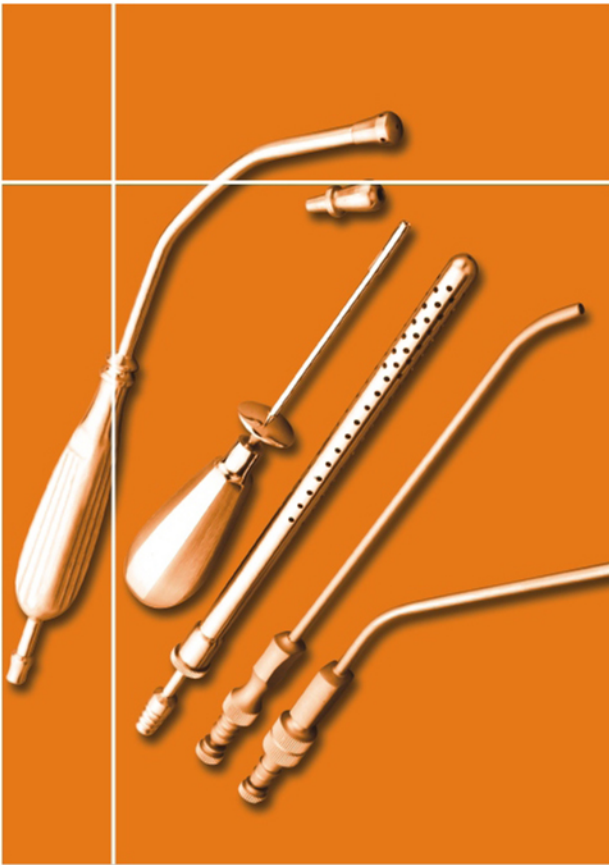

PAGE 001 to 017

- EN Trocars and Suction Tubes
- DE Trokare und Saugrohre
- ES Trócares y tubos de aspiración

SERVING HEALTHCARE WORLDWIDE

[WWW.g14surgicals.com](http://WWW.g14surgicals.com)



Trocars EN

Trokare DE

Trócares ES

06

# TROCARS & SUCTION TUBES

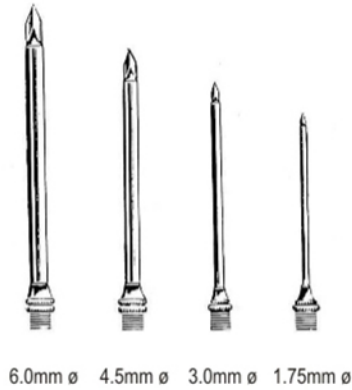

6.0mm Ø 4.5mm Ø 3.0mm Ø 1.75mm Ø

### UNIVERSAL

G14.06.0010.03 Set of 3 pieces

G14.06.0010.04 Set of 4 pieces



### UNIVERSAL

G14.06.0016.03 Set of 3 pieces

G14.06.0016.04 Set of 4 pieces



### HYDROCELE

12.0cm

G14.06.0022.08 8 FG Ø

G14.06.0022.09 9 FG Ø

G14.06.0022.10 10 FG Ø



### ASCITES

15.0cm

G14.06.0028.16 16 FG Ø

G14.06.0028.21 21 FG Ø



### EXPLORING

G14.06.0034.08 8 FG Ø

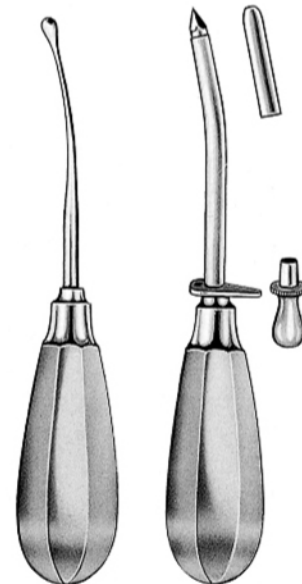

### KRAUSE

G14.06.0040.30 3.0mm Ø

G14.06.0040.40 4.0mm Ø

G14.06.0040.50 5.0mm Ø

G14.06.0040.55 5.5mm Ø

06.0040.55

06-001

www.g14surgical.com

EN Trocars

DE Trokare

ES Trócares



## TROCARS & SUCTION TUBES

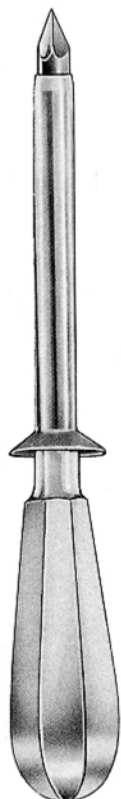

**NELSON**  
21.0cm

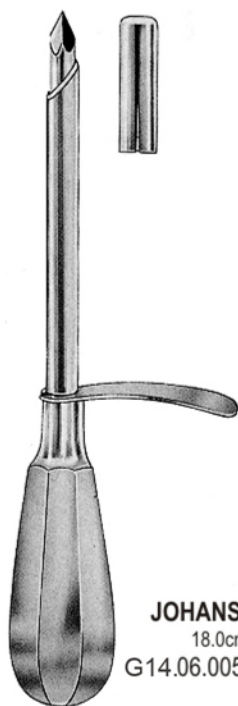

**JOHANSSON**  
18.0cm  
G14.06.0056.90 9mm Ø



1

G14.06.0048.25 25 FG



2

G14.06.0048.30 30 FG



3

G14.06.0048.33 33 FG

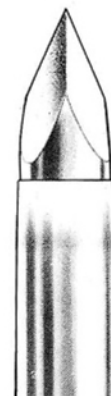

4

G14.06.0048.35 35 FG



**BILLROTH**  
24.0cm  
G14.06.0060.50 5mm Ø  
G14.06.0060.60 6mm Ø

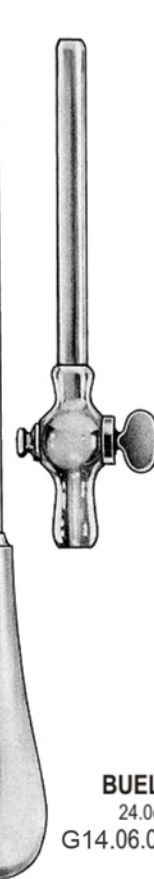
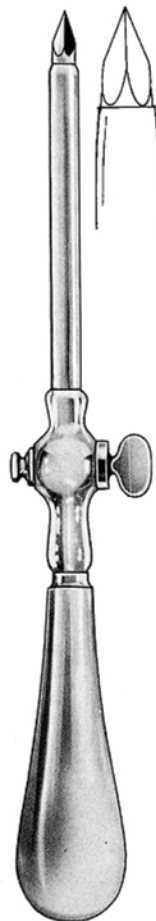

**BUELAU**  
24.0cm  
G14.06.0066.80 8mm Ø

06.0066.80

**06-002**

www.g14surgical.com

Trocars EN

Trokare DE

Trócares ES

06

# TROCARS & SUCTION TUBES



**FLEURANT**  
23.0cm  
G14.06.0074.50 5mm Ø



**FLEURANT**  
23.0cm  
G14.06.0080.50 5mm Ø



**STANDARD 11.0cm**

- G14.06.0090.30 3.0mm Ø
- G14.06.0090.35 3.5mm Ø
- G14.06.0090.40 4.0mm Ø
- G14.06.0090.45 4.5mm Ø
- G14.06.0090.50 5.0mm Ø
- G14.06.0090.55 5.5mm Ø
- G14.06.0090.60 6.0mm Ø

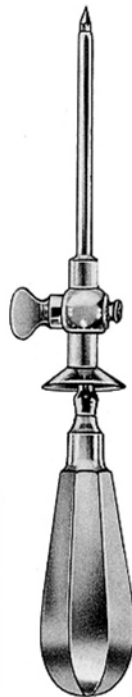

**STANDARD 12.0cm**

- G14.06.0094.30 3.0mm Ø
- G14.06.0094.35 3.5mm Ø
- G14.06.0094.40 4.0mm Ø
- G14.06.0094.45 4.5mm Ø
- G14.06.0094.50 5.0mm Ø
- G14.06.0094.55 5.5mm Ø
- G14.06.0094.60 6.0mm Ø



**STANDARD 12.0cm**

- G14.06.0098.30 3.0mm Ø
- G14.06.0098.35 3.5mm Ø
- G14.06.0098.40 4.0mm Ø
- G14.06.0098.45 4.5mm Ø
- G14.06.0098.50 5.0mm Ø
- G14.06.0098.55 5.5mm Ø
- G14.06.0098.60 6.0mm Ø

06.0098.60

**06-003**

[www.g14surgical.com](http://www.g14surgical.com)

EN Trocars

DE Trokare

ES Trócares



## TROCARS & SUCTION TUBES

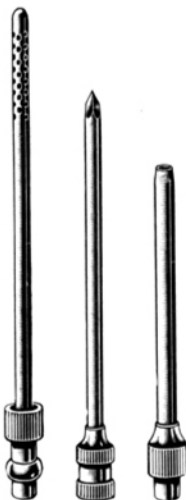

**DUKE**  
11.0cm  
G14.06.0104.55 5.5mm Ø

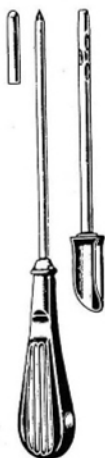

**BIRCH**  
18.0cm  
G14.06.0108.45 4.5mmØ



**OCHSNER**  
G14.06.0110.10 10 FG Ø  
G14.06.0110.12 12 FG Ø  
G14.06.0110.14 14 FG Ø  
G14.06.0110.16 16 FG Ø  
G14.06.0110.18 18 FG Ø  
G14.06.0110.20 20 FG Ø  
G14.06.0110.22 22 FG Ø



**OCHSNER**  
G14.06.0112.10 10 FG Ø  
G14.06.0112.12 12 FG Ø  
G14.06.0112.14 14 FG Ø  
G14.06.0112.16 16 FG Ø  
G14.06.0112.18 18 FG Ø  
G14.06.0112.20 20 FG Ø  
G14.06.0112.22 22 FG Ø



**PIERCE**  
G14.06.0128.30 3.0mm Ø  
G14.06.0128.40 4.0mm Ø  
G14.06.0128.50 5.0mm Ø



**LANDAU**  
G14.06.0134.20 2.0mm Ø

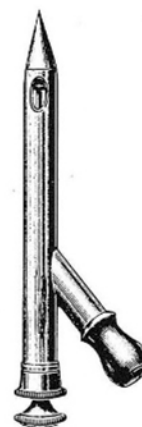

**PEAN**  
G14.06.0140.13 13.5mm Ø

06.0140.13

**06-004**

www.g14surgical.com

Trocars EN

Trokare DE

Trócares ES

06

# TROCARS & SUCTION TUBES

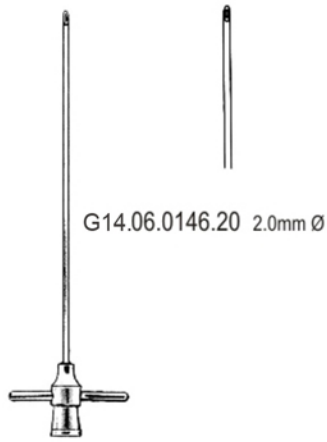

G14.06.0146.20 2.0mm Ø

**RUSKIN**



G14.06.0148.20 2.0mm Ø

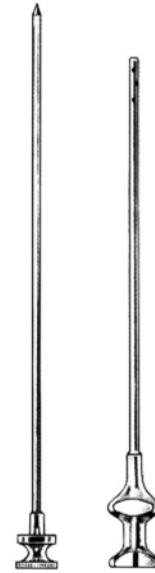

**EICKEN**

10.5cm

G14.06.0156.18 1.8mm Ø

G14.06.0156.20 2.0mm Ø

G14.06.0156.30 3.0mm Ø



**DOUGLAS**

G14.06.0162.30 3.0mm Ø

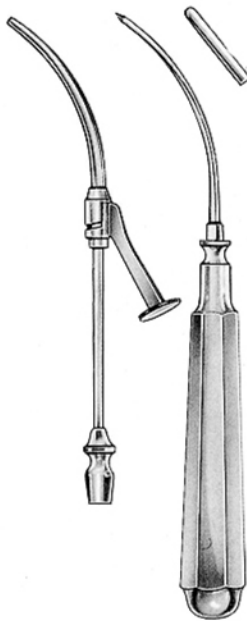

**COAKLEY**

G14.06.0166.22 2.25mm Ø

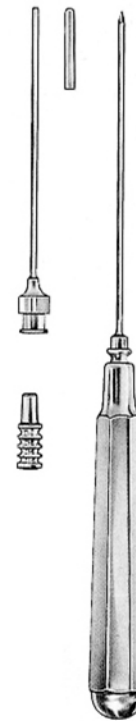

**LICHTWITZ**

G14.06.0170.12 1.25mm Ø

G14.06.0170.15 1.50mm Ø

G14.06.0170.18 1.80mm Ø

06.0170.18

**06-005**

[www.g14surgical.com](http://www.g14surgical.com)

EN Guide Needles

DE Führungsnadeln

ES Agujas de guía



## TROCARS & SUCTION TUBES



SCHMID

G14.06.0176.30 3.0mm Ø



G14.06.0176.40 4.0mm Ø



G14.06.0176.50 5.0mm Ø



G14.06.0176.60 6.0mm Ø



IOWA

G14.06.0182.14 14.0cm



8 FG G14.06.0190.08

10 FG G14.06.0190.10

12 FG G14.06.0190.12

14 FG G14.06.0190.14

16 FG G14.06.0190.16

18 FG G14.06.0190.18

G14.06.0192.08

G14.06.0192.10

G14.06.0192.12

G14.06.0192.14

G14.06.0192.16

G14.06.0192.18



G14.06.0194.08

G14.06.0194.10

G14.06.0194.12

G14.06.0194.14

G14.06.0194.16

G14.06.0194.18



VERRES

G14.06.0202.55 1.5 x 55mm Ø

G14.06.0202.10 2.0 x 100mm Ø

G14.06.0202.12 2.0 x 120mm Ø

G14.06.0202.15 2.0 x 150mm Ø

06.0202.15

**06-006**

www.g14surgical.com

TROCARS & SUCTION TUBES



**FERGUSSON**



**FERGUSSON**



**POPPIEN**

	11.0cm	13.0cm	20.0cm
1.5mm Ø	G14.06.0210.15	G14.06.0212.15	G14.06.0218.15
2.0mm Ø	G14.06.0210.20	G14.06.0212.20	G14.06.0218.20
2.5mm Ø	G14.06.0210.25	G14.06.0212.25	G14.06.0218.25
3.0mm Ø	G14.06.0210.30	G14.06.0212.30	G14.06.0218.30
4.0mm Ø	G14.06.0210.40	G14.06.0212.40	G14.06.0218.40
5.0mm Ø	G14.06.0210.50	G14.06.0212.50	G14.06.0218.50

G14.06.0222.05	05 FG
G14.06.0222.06	06 FG
G14.06.0222.07	07 FG
G14.06.0222.08	08 FG
G14.06.0222.09	09 FG
G14.06.0222.10	10 FG
G14.06.0222.12	12 FG

	13.0cm
G14.06.0228.06	06 FG
G14.06.0228.08	08 FG
G14.06.0228.10	10 FG
G14.06.0228.12	12 FG

	16.0cm	18.0cm
G14.06.0214.15	G14.06.0216.15	
G14.06.0214.20	G14.06.0216.20	
G14.06.0214.25	G14.06.0216.25	
G14.06.0214.30	G14.06.0216.30	
G14.06.0214.40	G14.06.0216.40	
G14.06.0214.50	G14.06.0216.50	



**POPPIEN**

	13.0cm
G14.06.0234.08	08 FG
G14.06.0234.10	10 FG



**FRAZIER**

Charr.	19.0cm	
FG	30°	75°
06	G14.06.0240.06	G14.06.0242.06
07	G14.06.0240.07	G14.06.0242.07
08	G14.06.0240.08	G14.06.0242.08
09	G14.06.0240.09	G14.06.0242.09
10	G14.06.0240.10	G14.06.0242.10
11	G14.06.0240.11	G14.06.0242.11
12	G14.06.0240.12	G14.06.0242.12



**FRAZIER**

	19.0cm
G14.06.0246.08	08 FG
G14.06.0246.10	10 FG

06.0246.10

**06-007**

www.g14surgical.com

EN Suction Tubes

DE Saugrohre

ES Tubos de aspiración



## TROCARS & SUCTION TUBES



**PLESTER**

17.0cm

- G14.06.0252.15 1.5mm Ø
- G14.06.0252.20 2.0mm Ø
- G14.06.0252.25 2.5mm Ø
- G14.06.0252.30 3.0mm Ø



**ADSON**

16.5cm

- G14.06.0258.80 3mm Ø
- Olive 8mm Ø



**ADSON**

21.0cm

- G14.06.0266.40 4mm Ø



**LEMPERT**

20.0cm

- G14.06.0272.20 2.0mm Ø
- G14.06.0272.30 3.0mm Ø
- Olive 7-9mm Ø



Olive 8mm Ø

**BARRON**

16.0cm

- G14.06.0278.13 1.3mm Ø
- G14.06.0278.20 2.0mm Ø



**SCHUHKNECHT**

13.0cm

- G14.06.0284.05 0.5mm Ø
- G14.06.0284.10 1.0mm Ø
- G14.06.0284.20 2.0mm Ø
- G14.06.0284.30 3.0mm Ø



**WULLSTEIN (set)**

G14.06.0290.00 14.0cm



0.4mm



0.6mm



0.8mm

G14.06.0290.04

G14.06.0290.06

G14.06.0290.08

06.0290.00

**06-008**

www.g14surgical.com

## TROCARS &amp; SUCTION TUBES

**ZOELLNER** (each 10 Pieces)

- G14.06.0302.04 0.4mm Ø
- G14.06.0302.05 0.5mm Ø
- G14.06.0302.07 0.7mm Ø
- G14.06.0302.10 1.0mm Ø
- G14.06.0302.12 1.2mm Ø



- ZOELLNER**  
18.0cm
- G14.06.0300.00 ( Set )
  - G14.06.0300.01 ( Cannula only 2.5mm Ø )  
(Complete consists of suction cannula and detachable ends 06.0302.04 to 06.0302.12)



- BELLUCCI**  
15.0cm
- G14.06.0310.00 ( Set )
  - G14.06.0310.01 ( Cannula only )  
(Complete consists of suction cannula and detachable ends 06.0302.05, 06.0302.07 & 06.0302.10 )



- G14.06.0316.20 2.0mm Ø
- G14.06.0316.25 2.5mm Ø
- G14.06.0316.30 3.0mm Ø  
( 90° to curve with LUER hub )

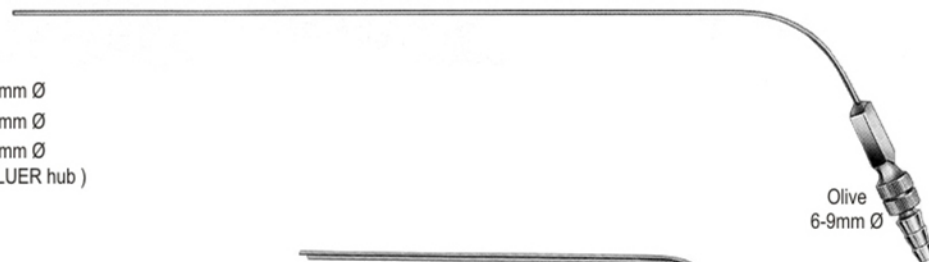

- HOUSE**
- G14.06.0322.09 0.9mm Ø , 0.7mm Ø
  - G14.06.0322.12 1.2mm Ø , 0.9mm Ø
  - G14.06.0322.15 1.5mm Ø , 1.2mm Ø

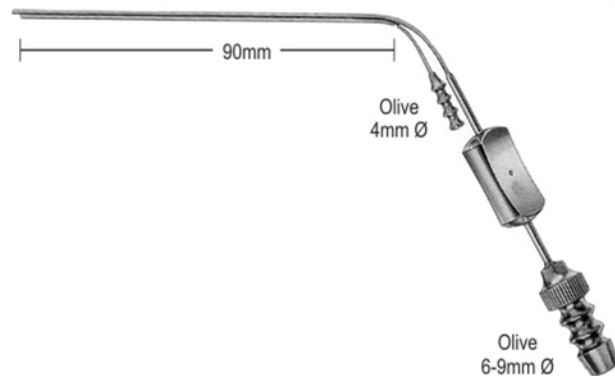

06.0322.15

**06-009**

www.g14surgical.com

EN Suction Tubes

DE Saugrohre

ES Tubos de aspiración



## TROCARS & SUCTION TUBES

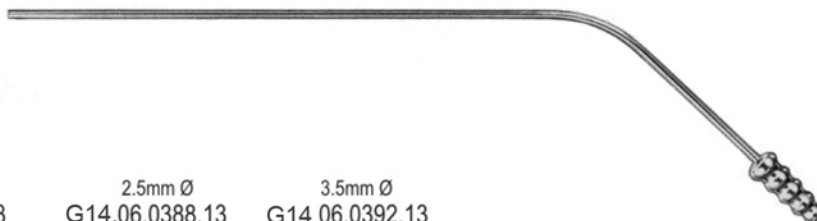

### YASARGIL

Length	1.5mm Ø	2.0mm Ø	2.5mm Ø	3.5mm Ø
13.0cm	G14.06.0380.13	G14.06.0384.13	G14.06.0388.13	G14.06.0392.13
15.0cm	G14.06.0380.15	G14.06.0384.15	G14.06.0388.15	G14.06.0392.15
18.0cm	G14.06.0380.18	G14.06.0384.18	G14.06.0388.18	G14.06.0392.18
22.0cm	G14.06.0380.22	G14.06.0384.22	G14.06.0388.22	G14.06.0392.22



G14.06.0402.35 35.0cm  
 G14.06.0402.50 50.0cm  
 ( With Rubber Tip )

### MAGILL

G14.06.0408.30	3.0mm Ø
G14.06.0408.35	3.5mm Ø
G14.06.0408.40	4.0mm Ø
G14.06.0408.45	4.5mm Ø



G14.06.0408.01 Stilette for MAGILL suction tubes

06.0408.01

**06-010**

[www.g14surgicals.com](http://www.g14surgicals.com)

Suction Tubes EN

Saugrohre DE

Tubos de aspiración ES

06

## TROCARS & SUCTION TUBES

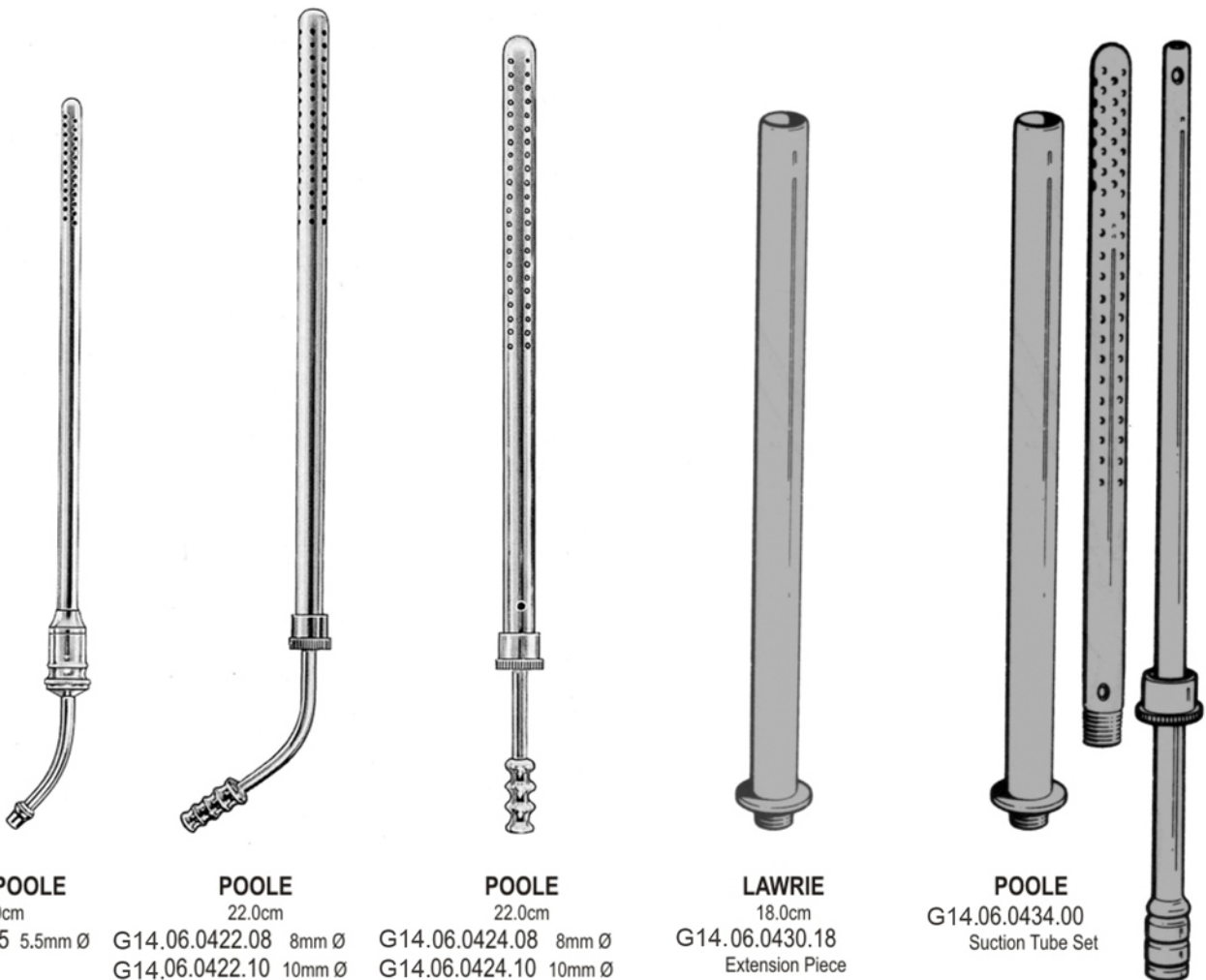

**BABY POOLE**

20.0cm

G14.06.0420.55 5.5mm Ø

**POOLE**

22.0cm

G14.06.0422.08 8mm Ø  
G14.06.0422.10 10mm Ø

**POOLE**

22.0cm

G14.06.0424.08 8mm Ø  
G14.06.0424.10 10mm Ø

**LAWRIE**

18.0cm

G14.06.0430.18  
Extension Piece

**POOLE**

G14.06.0434.00

Suction Tube Set

06.0434.00

**06-011**

[www.g14surgical.com](http://www.g14surgical.com)

06

EN Suction Tubes

DE Saugrohre

ES Tubos de aspiración



## TROCARS & SUCTION TUBES



**COOLEY**  
30.0cm  
G14.06.0440.30 7mm Ø



**COOLEY**  
31.0cm  
G14.06.0442.31 10mm Ø

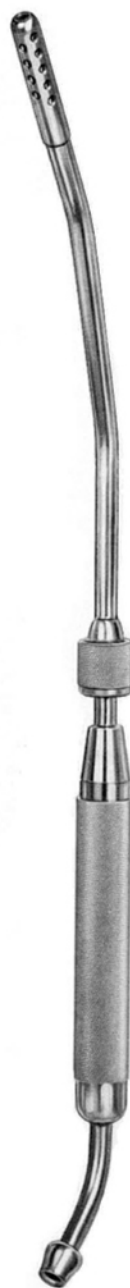

**COOLEY**  
33.0cm  
G14.06.0444.33 8mm Ø



**COOLEY**  
35.0cm  
G14.06.0446.35 8mm Ø

06.0446.35

**06-012**

[www.g14surgicals.com](http://www.g14surgicals.com)

Suction Tubes EN

Saugrohre DE

Tubos de aspiración ES

06

# TROCARS & SUCTION TUBES



G14.06.0456.01 10mm Ø

G14.06.0454.01

G14.06.0450.01 8mm Ø

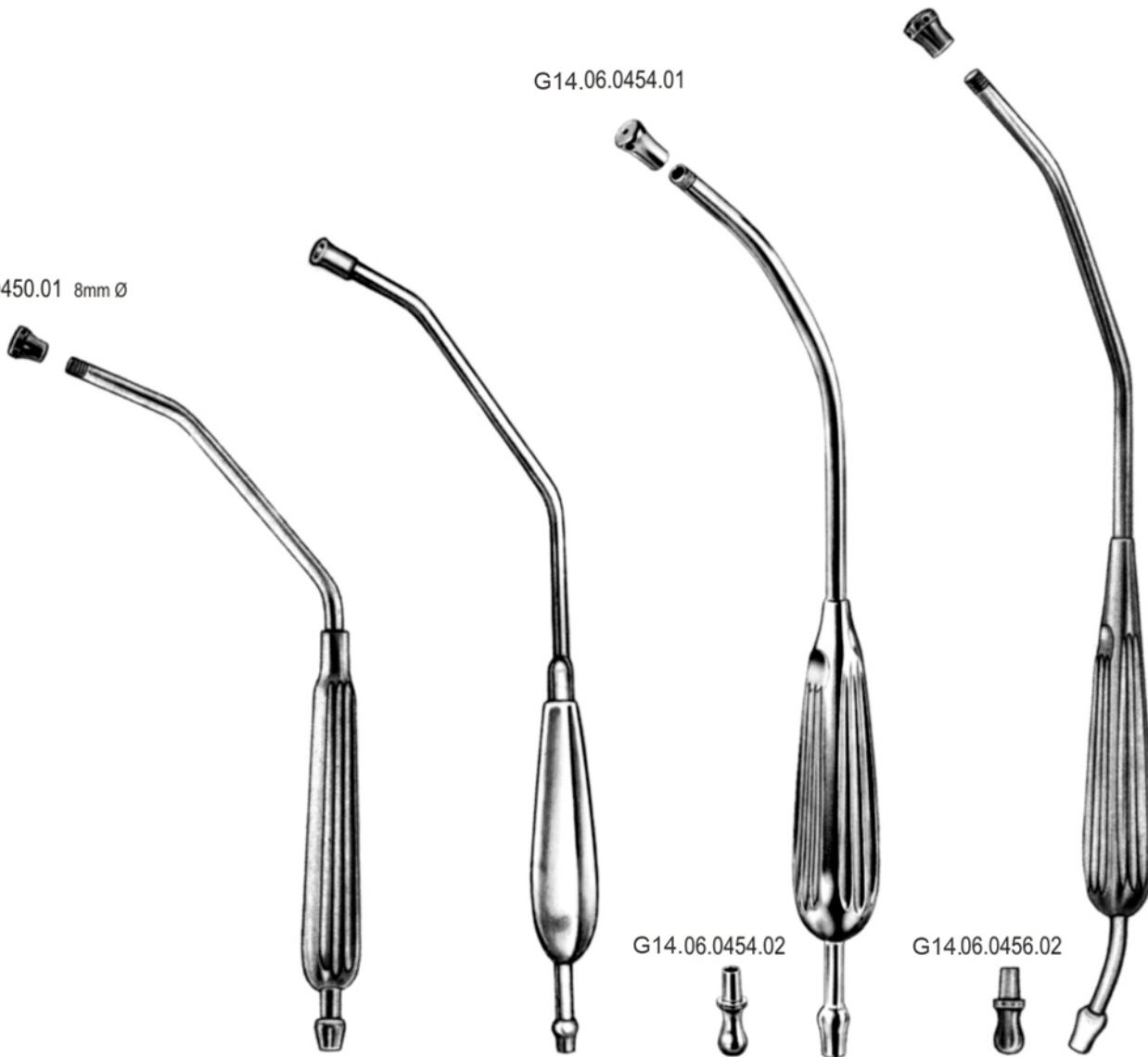

**BABY.YANKAUER**  
21.0cm  
G14.06.0450.21 5mm Ø

**YANKAUER**  
34.5cm  
G14.06.0452.34

**YANKAUER**  
G14.06.0454.27 27.0cm  
G14.06.0454.35 35.0cm

**YANKAUER**  
29.5cm  
G14.06.0456.29 6mm Ø

06.0456.29

**06-013**

[www.g14surgical.com](http://www.g14surgical.com)

## TROCARS & SUCTION TUBES

G14.06.0460.03



Fig.0

G14.06.0460.10

1

G14.06.0460.11

2

G14.06.0460.12

3

G14.06.0460.13

2.0mm Ø

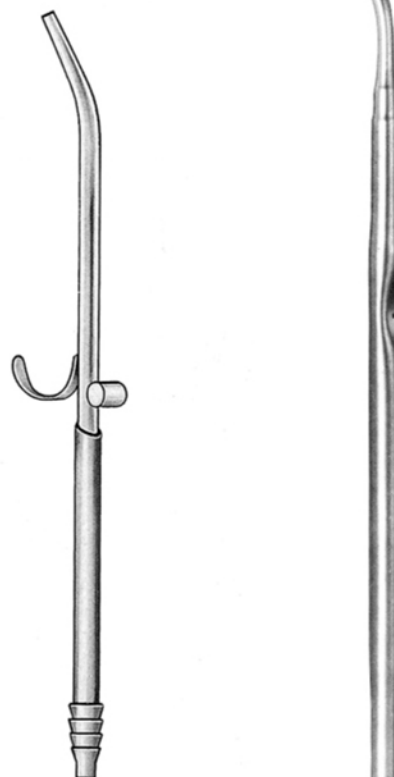

◀ G14.06.0460.01



G14.06.0460.02

**YANKAUER**

27.0cm

G14.06.0460.27 set

**BYRD**

G14.06.0470.15 1.5mm Ø

G14.06.0470.25 2.5mm Ø

G14.06.0470.35 3.5mm Ø

**COGSWELL**

23.0cm

G14.06.0474.23 2.0mm Ø

06

EN Suction Tubes

DE Saugrohre

ES Tubos de aspiración



## TROCARS & SUCTION TUBES

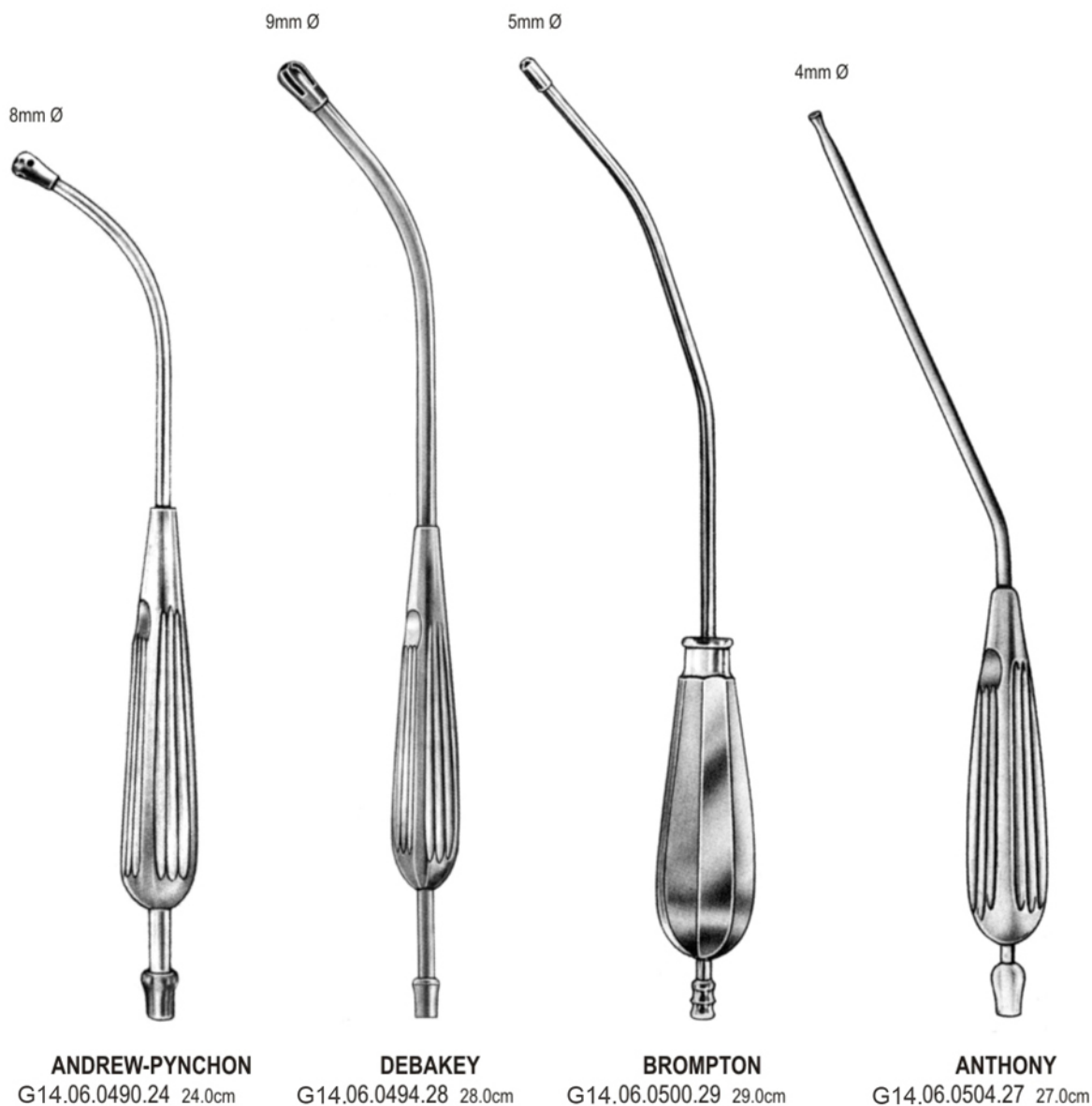

06.0504.27

06-016

www.g14surgical.com

Suction Tubes EN

Saugrohre DE

Tubos de aspiración ES

06

## TROCARS & SUCTION TUBES

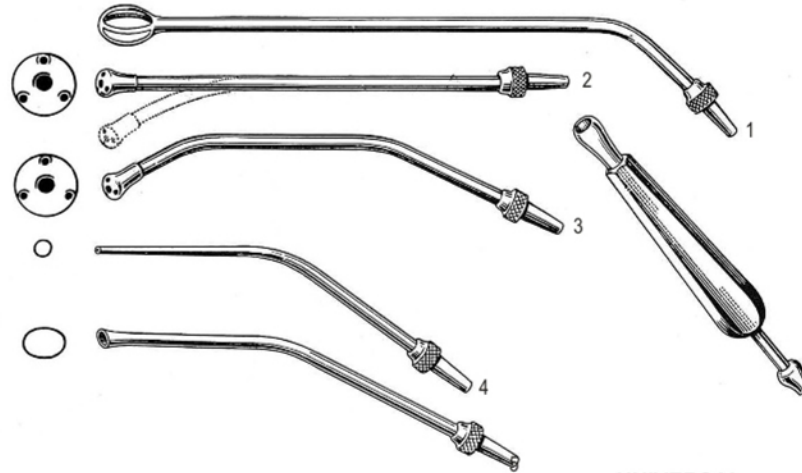

**UNIVERSAL**  
G14.06.0510.00 (Set)

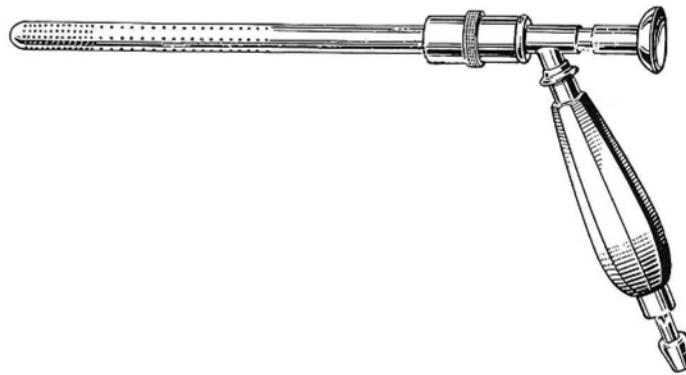

**SIMPSON-SMITH**  
G14.06.0514.00 (Complete)

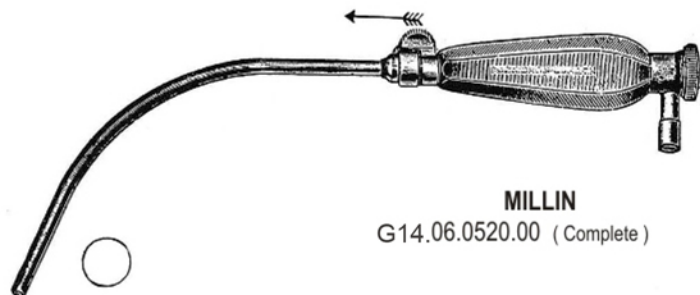

**MILLIN**  
G14.06.0520.00 (Complete)

06.0520.00

**06-017**

[www.g14surgical.com](http://www.g14surgical.com)