

# ARTERY FORCEPS

# 14



PAGE 001 to 042



- EN Artery Forceps
- DE Arterienklemmen
- ES Pinzas hemostáticas

SERVING HEALTHCARE WORLDWIDE

[WWW.g14surgical.com](http://WWW.g14surgical.com)



Bulldog Clamps, Setting Forceps EN

Bulldogklemmen, Alegepinzetten DE

Clamps bulldog, pinzas para poner ES

# 14

## ARTERY FORCEPS



DIEFFENBACH

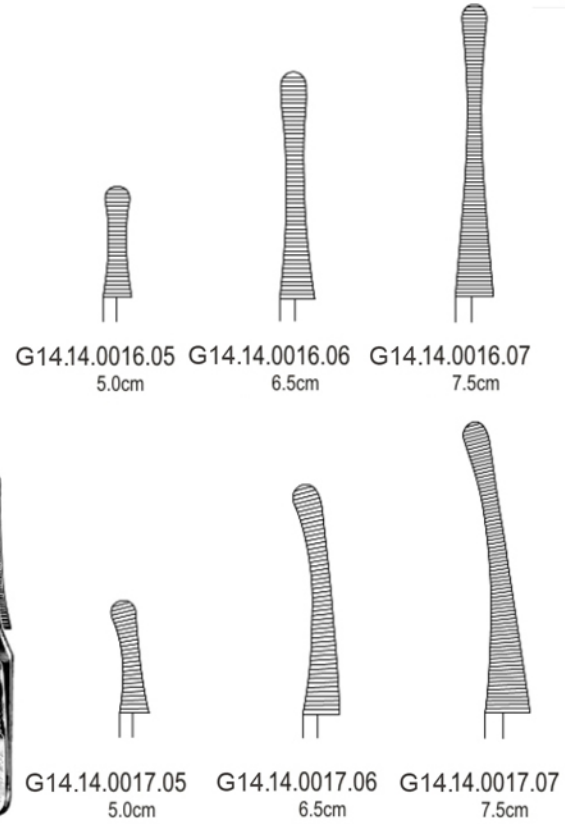

JOHNS-HOPKINS

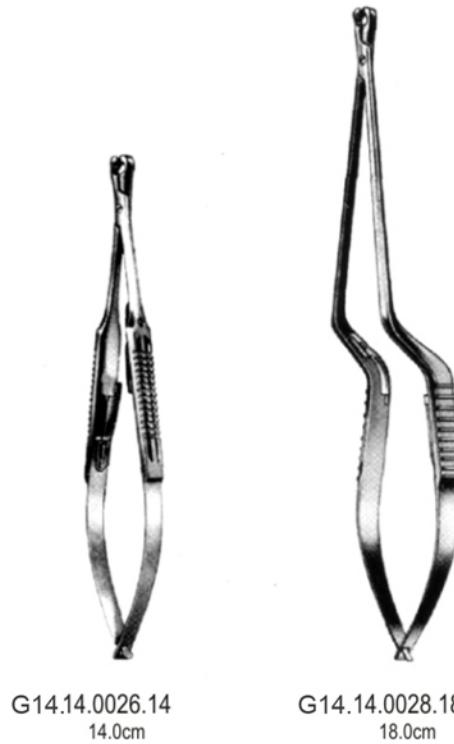
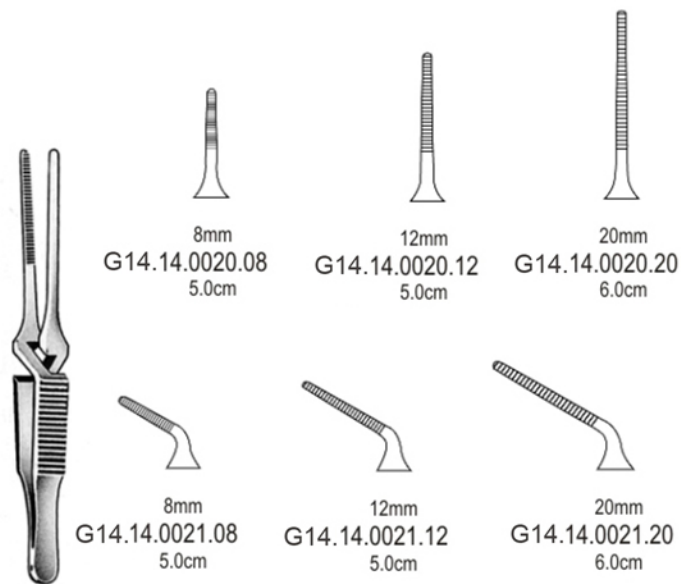

14.0028.18

**14-001**

[www.g14surgicals.com](http://www.g14surgicals.com)

EN Artery Forceps

DE Arterienklemmen

ES Pinzas hemostaticas



## ARTERY FORCEPS



**HARTMANN**

G14.14.0030.10 10.0cm  
G14.14.0031.10

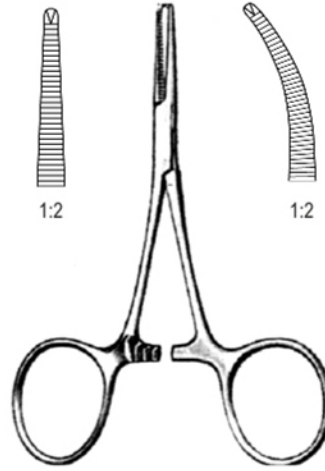

**HARTMANN**

G14.14.0032.10 10.0cm  
G14.14.0033.10



**CARREL**

G14.14.0040.08 8.5cm

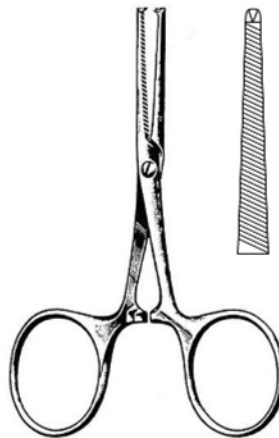

**TERRIER**

G14.14.0044.08 8.5cm

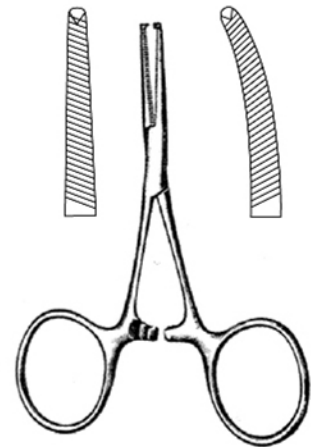

**TERRIER**

G14.14.0048.09 9.0cm  
G14.14.0049.09

14.0049.09

**14-002**

[www.g14surgical.com](http://www.g14surgical.com)

ARTERY FORCEPS

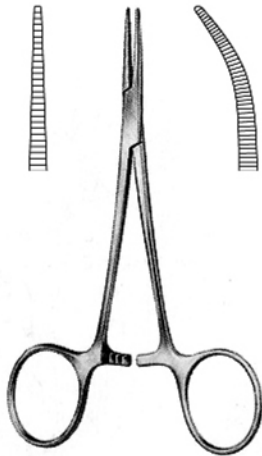

**HALSTED-MOSQUITO**

G14.14.0060.12 12.5cm G14.14.0061.12  
G14.14.0060.14 14.0cm G14.14.0061.14

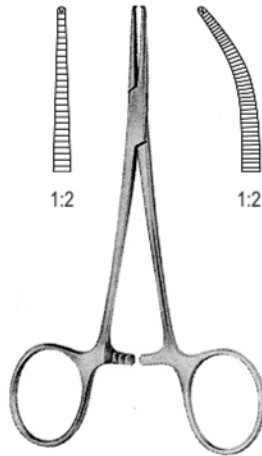

**HALSTED-MOSQUITO**

G14.14.0062.12 12.5cm G14.14.0063.12  
G14.14.0062.14 14.0cm G14.14.0063.14

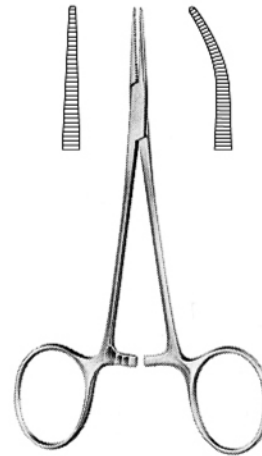

**MICRO-MOSQUITO**

G14.14.0070.10 10.0cm G14.14.0071.10  
G14.14.0070.12 12.0cm G14.14.0071.12  
G14.14.0070.14 14.0cm G14.14.0071.14

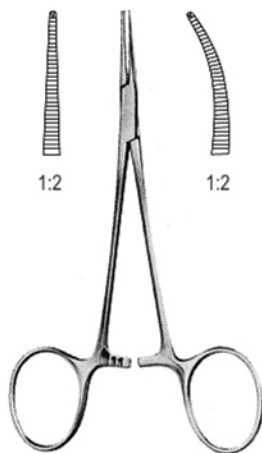

**MICRO-MOSQUITO**

G14.14.0072.10 10.0cm G14.14.0073.10  
G14.14.0072.12 12.0cm G14.14.0073.12  
G14.14.0072.14 14.0cm G14.14.0073.14

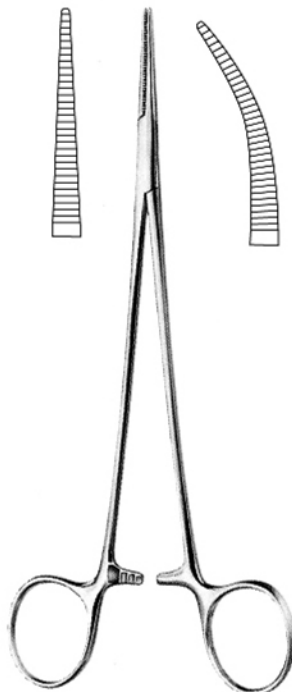

**HALSTED-MOSQUITO**

G14.14.0080.16 16.0cm G14.14.0081.16  
G14.14.0080.18 18.0cm G14.14.0081.18  
G14.14.0080.21 21.0cm G14.14.0081.21

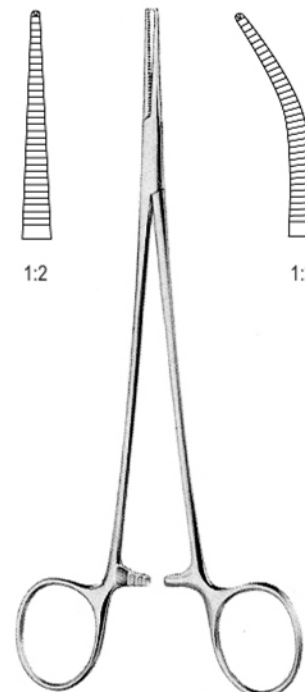

**HALSTED-MOSQUITO**

G14.14.0082.16 16.0cm G14.14.0083.16  
G14.14.0082.18 18.0cm G14.14.0083.18  
G14.14.0082.21 21.0cm G14.14.0083.21

14.0083.21

**14-003**

www.g14surgical.com

EN Artery Forceps

DE Arterienklemmen

ES Pinzas hemostaticas



## ARTERY FORCEPS

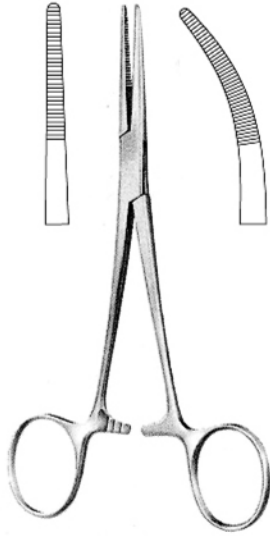

**KELLY**

G14.14.0090.14 14.0cm  
G14.14.0091.14

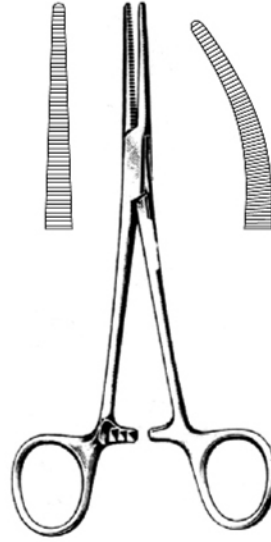

**CRILE**

G14.14.0094.14 14.0cm  
G14.14.0095.14

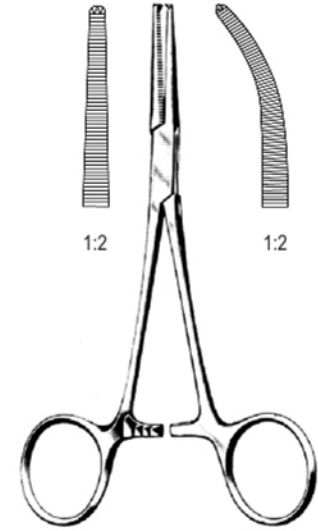

**CRILE**

G14.14.0096.14 14.0cm  
G14.14.0097.14

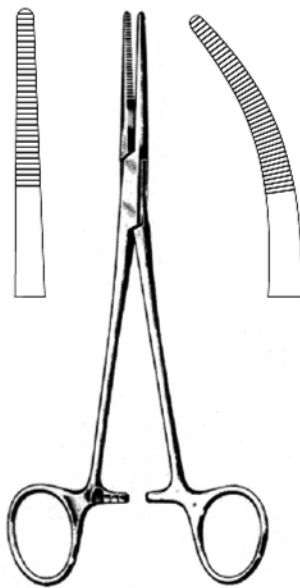

**RANKIN-KELLY**

G14.14.0100.16 16.0cm  
G14.14.0101.16

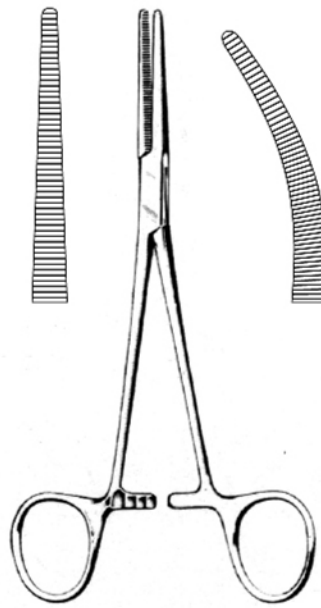

**RANKIN-CRILE**

G14.14.0104.16 16.0cm  
G14.14.0105.16

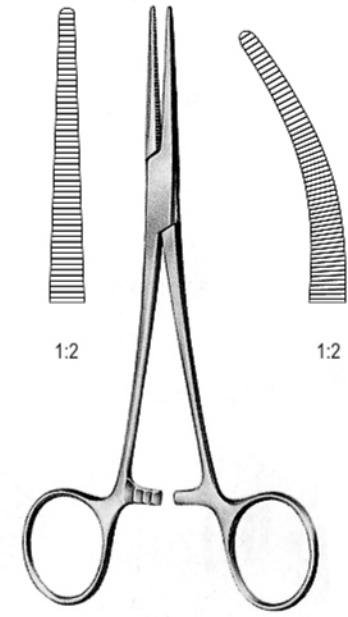

**CRILE-RANKIN**

G14.14.0106.16 16.0cm  
G14.14.0107.16

14.0107.16

**14-004**

[www.g14surgicals.com](http://www.g14surgicals.com)

Artery Forceps EN

Arterienklemmen DE

Pinzas hemostaticas ES

14

ARTERY FORCEPS

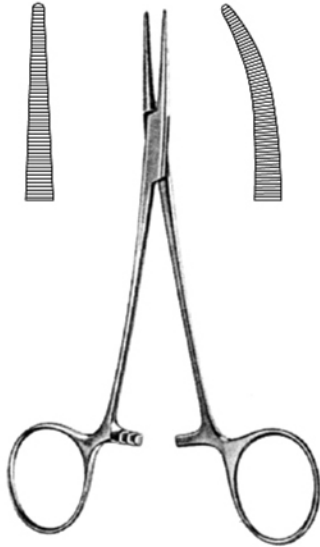

**CRILE-DELICATE**

G14.14.0110.14 14.0cm G14.14.0111.14

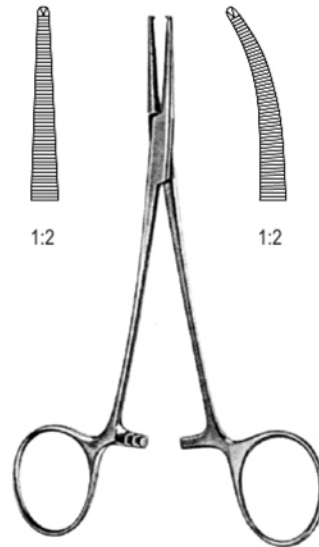

**CRILE-DELICATE**

G14.14.0116.14 14.0cm G14.14.0117.14

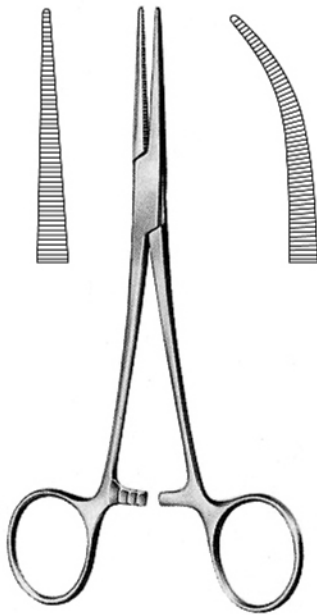

**COLLER-CRILE**

G14.14.0120.14 14.0cm G14.14.0121.14  
G14.14.0120.16 16.0cm G14.14.0121.16

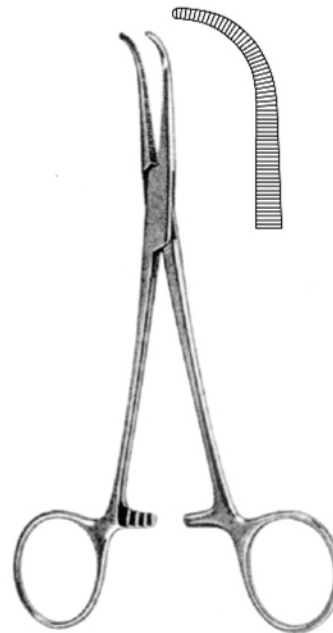

**COLLER-CRILE**

G14.14.0126.16 16.0cm

14.0126.16

**14-005**

[www.g14surgical.com](http://www.g14surgical.com)

EN Artery Forceps

DE Arterienklemmen

ES Pinzas hemostaticas



## ARTERY FORCEPS

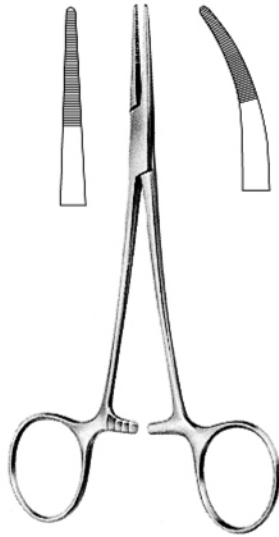

**PROVIDENCE-HOSPITAL**  
14.0130.14 14.0cm

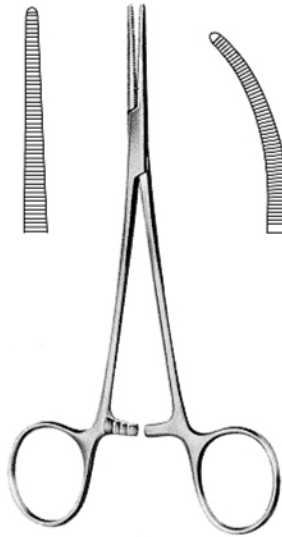

**LERICHE**  
G14.14.0136.15 15.0cm  
G14.14.0137.15

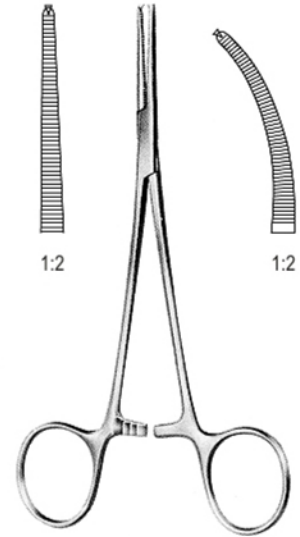

**LERICHE**  
G14.14.0138.15 15.0cm  
G14.14.0139.15

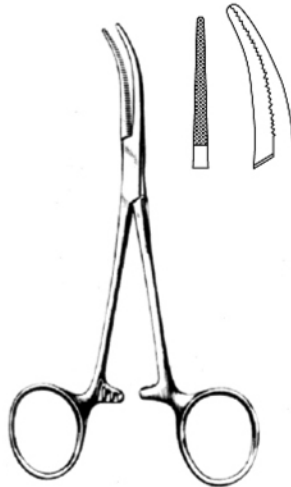

**BABY-DANDY**  
G14.14.0140.12 12.0cm

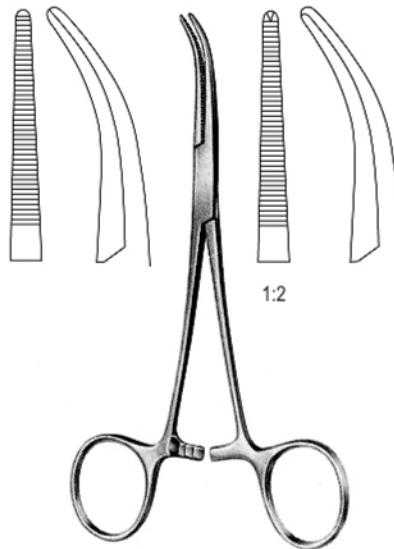

**DANDY**  
G14.14.0142.14 14.0cm  
G14.14.0144.14

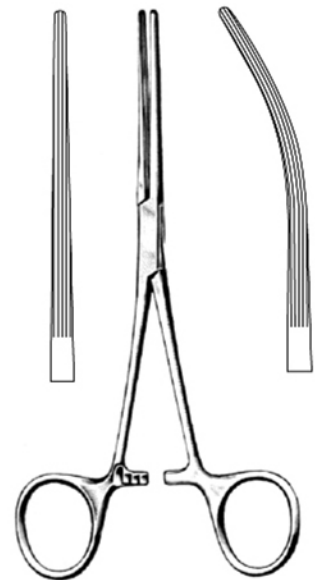

**BAINBRIDGE**  
G14.14.0150.15 15.0cm G14.14.0151.15  
G14.14.0150.18 18.5cm G14.14.0151.18

14.0151.18

**14-006**

www.g14surgicals.com

ARTERY FORCEPS

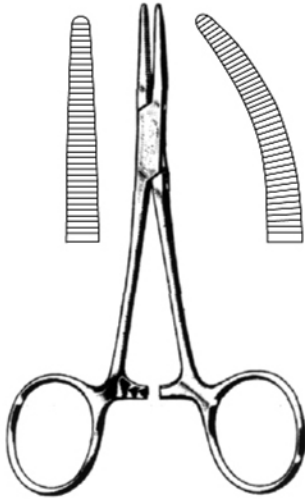

**JONES**

- G14.14.0156.12 12.5cm G14.14.0157.12
- G14.14.0156.15 15.0cm G14.14.0157.15

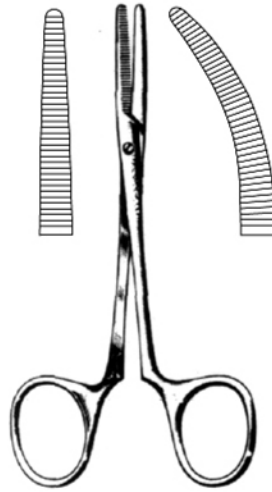

**SPENCER-WELLS**

- G14.14.0160.12 12.5cm G14.14.0161.12
- G14.14.0160.15 15.0cm G14.14.0161.15
- G14.14.0160.18 18.0cm G14.14.0161.18
- G14.14.0160.20 20.0cm G14.14.0161.20
- G14.14.0160.23 23.0cm G14.14.0161.23

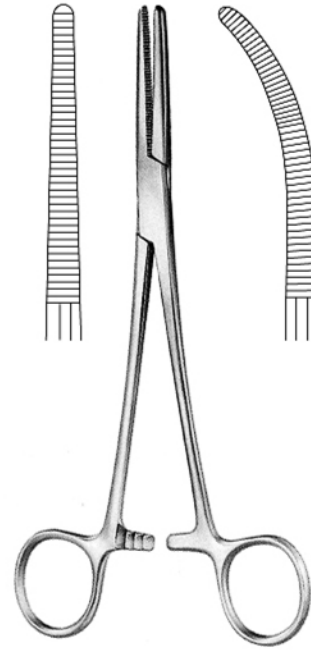

**SPENCER-WELLS**

- G14.14.0162.13 13.0cm G14.14.0163.13
- G14.14.0162.14 14.0cm G14.14.0163.14
- G14.14.0162.15 15.0cm G14.14.0163.15
- G14.14.0162.18 18.0cm G14.14.0163.18
- G14.14.0162.20 20.0cm G14.14.0163.20
- G14.14.0162.23 23.0cm G14.14.0163.23

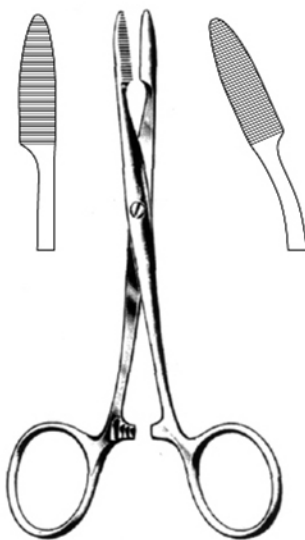

**PEAN**

- G14.14.0170.12 12.5cm G14.14.0171.12
- G14.14.0170.14 14.0cm G14.14.0171.14
- G14.14.0170.16 16.0cm G14.14.0171.16

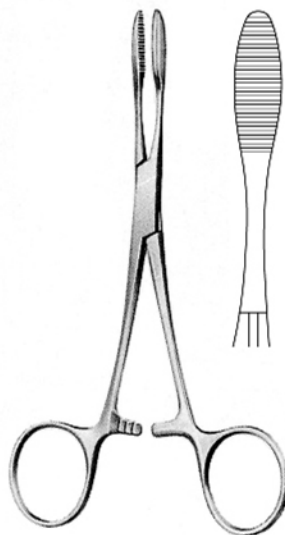

**PEAN**

- G14.14.0172.12 12.5cm
- G14.14.0172.14 14.0cm
- G14.14.0172.16 16.0cm

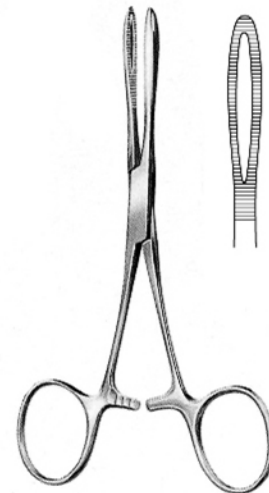

**KROENLIEN**

- G14.14.0176.14 14.0cm
- G14.14.0178.14

14.0178.14

**14-007**

[www.g14surgical.com](http://www.g14surgical.com)

EN Artery Forceps

DE Arterienklemmen

ES Pinzas hemostaticas



## ARTERY FORCEPS

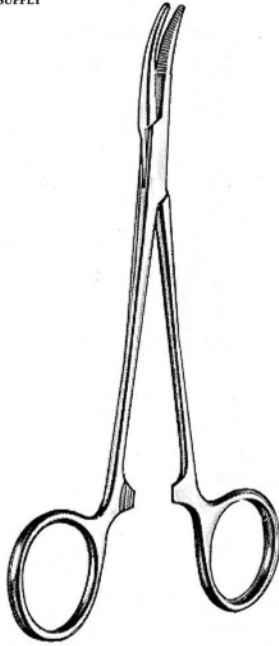

**CAIRNS**

G14.14.0180.14 14.5cm  
G14.14.0181.14

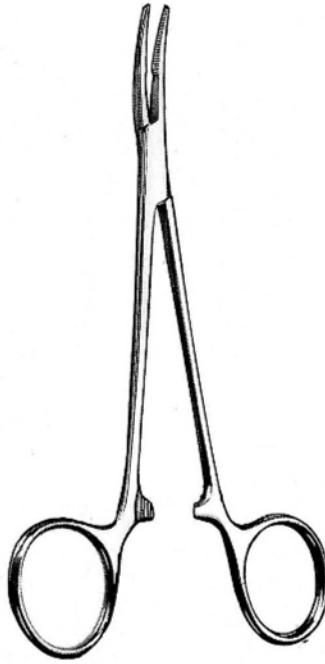

**CUSHING**

G14.14.0186.14 14.0cm  
G14.14.0187.14



**KILNER**

G14.14.0190.14 14.0cm  
G14.14.0191.14

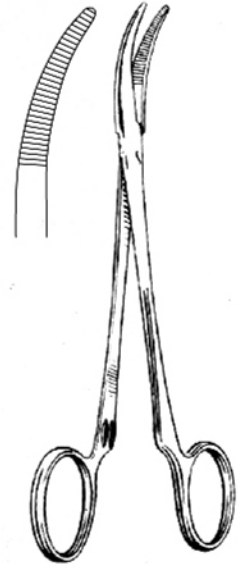

**KELLY**

14.0196.12 12.5cm

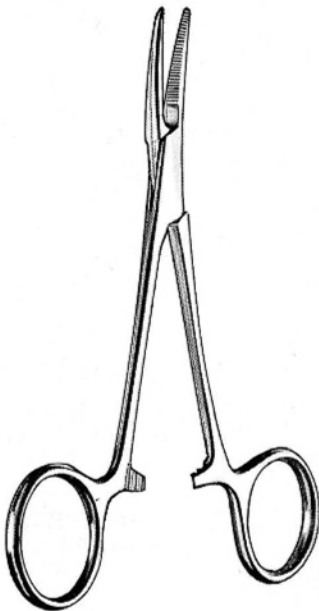

**DUNHILL**

G14.14.0200.12 12.5cm  
G14.14.0201.12

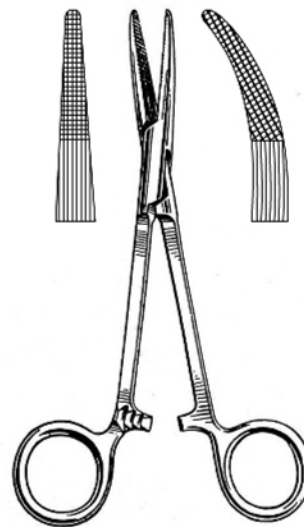

**GREY-TURNER**

G14.14.0206.15 15.0cm  
G14.14.0207.15

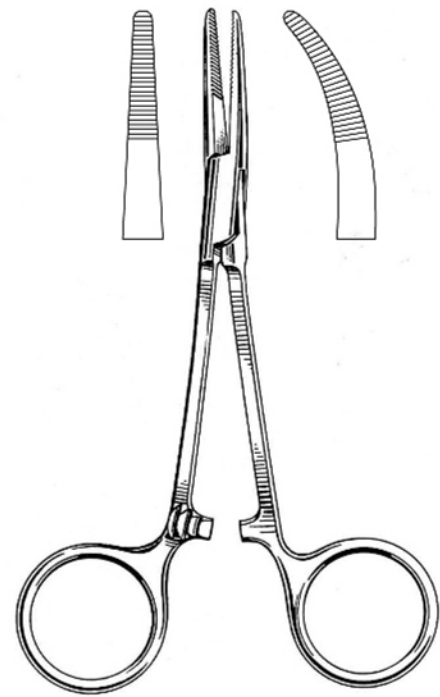

**MOYNIHAN**

G14.14.0210.14 14.5cm  
G14.14.0211.14

14.0211.14

**14-008**

www.g14surgical.com

ARTERY FORCEPS

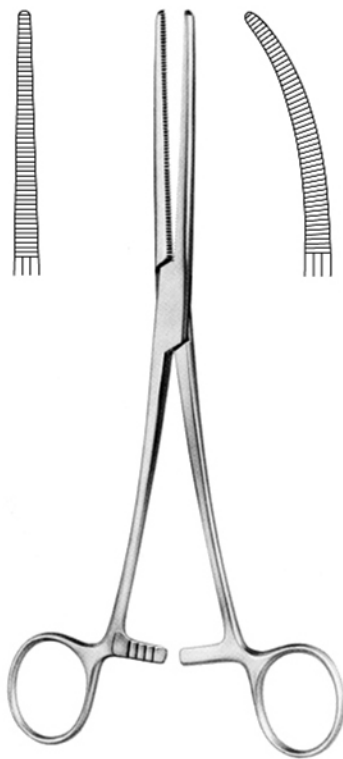

PEAN (ROCHESTER)

G14.14.0220.13	13.0cm	G14.14.0221.13
G14.14.0220.14	14.0cm	G14.14.0221.14
G14.14.0220.16	16.0cm	G14.14.0221.16
G14.14.0220.18	18.0cm	G14.14.0221.18
G14.14.0220.20	20.0cm	G14.14.0221.20
G14.14.0220.22	22.0cm	G14.14.0221.22
G14.14.0220.24	24.0cm	G14.14.0221.24
G14.14.0220.26	26.0cm	G14.14.0221.26
G14.14.0220.28	28.0cm	G14.14.0221.28
G14.14.0220.30	30.0cm	G14.14.0221.30

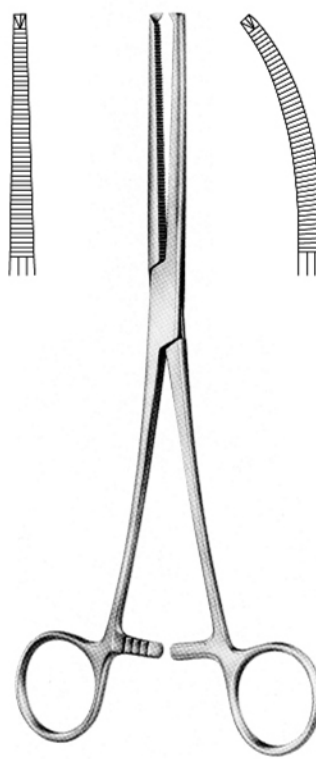

KOCHER (OCHSNER)

G14.14.0226.13	13.0cm	G14.14.0227.13
G14.14.0226.14	14.0cm	G14.14.0227.14
G14.14.0226.16	16.0cm	G14.14.0227.16
G14.14.0226.18	18.0cm	G14.14.0227.18
G14.14.0226.20	20.0cm	G14.14.0227.20
G14.14.0226.22	22.0cm	G14.14.0227.22
G14.14.0226.24	24.0cm	G14.14.0227.24
G14.14.0226.26	26.0cm	G14.14.0227.26
G14.14.0226.28	28.0cm	G14.14.0227.28
G14.14.0226.30	30.0cm	G14.14.0227.30

EN Artery Forceps

DE Arterienklemmen

ES Pinzas hemostaticas



## ARTERY FORCEPS

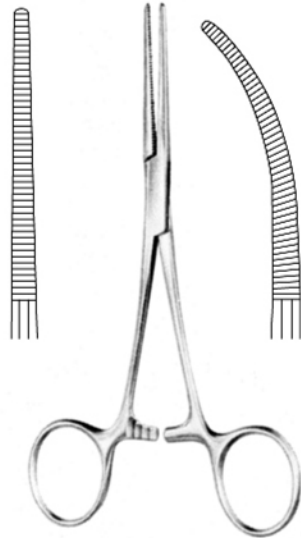

**PEAN (DELICATE)**

G14.14.0230.13	13.0cm	G14.14.0231.13
G14.14.0230.14	14.0cm	G14.14.0231.14
G14.14.0230.16	16.0cm	G14.14.0231.16

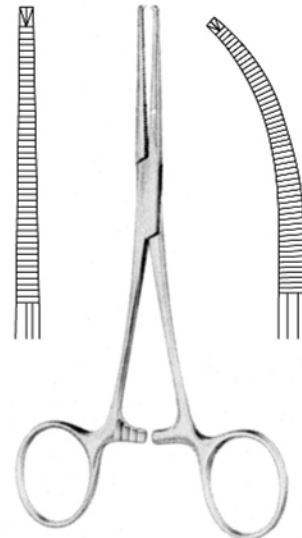

**KOCHER (DELICATE)**

G14.14.0236.13	13.0cm	G14.14.0237.13
G14.14.0236.14	14.0cm	G14.14.0237.14
G14.14.0236.16	16.0cm	G14.14.0237.16

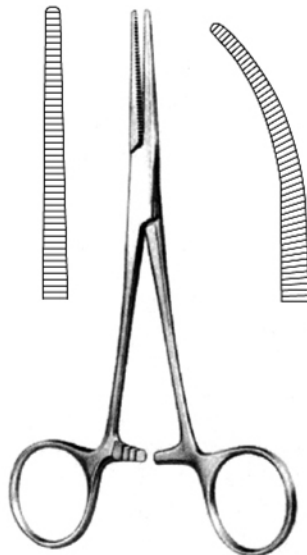

**PEAN-NIPPON**

G14.14.0240.14	14.5cm	G14.14.0241.14
G14.14.0240.16	16.0cm	G14.14.0241.16
G14.14.0240.18	18.0cm	G14.14.0241.18

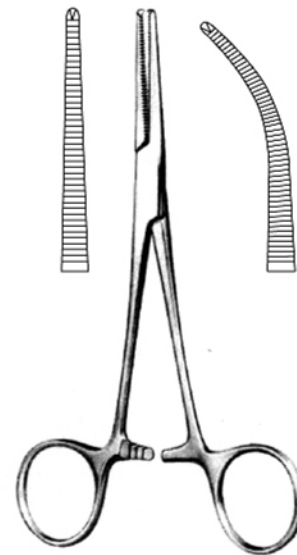

**KOCHER-NIPPON**

G14.14.0246.14	14.5cm	G14.14.0247.14
G14.14.0246.16	16.0cm	G14.14.0247.16
G14.14.0246.18	18.0cm	G14.14.0247.18

14.0247.18

**14-010**

www.g14surgical.com

Artery Forceps EN

Arterienklemmen DE

Pinzas hemostaticas ES

14

# ARTERY FORCEPS

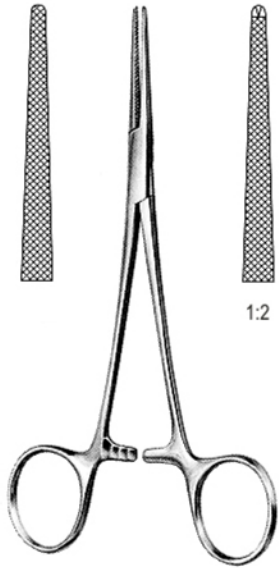

**LOVELACE**

G14.14.0250.15 15.5cm G14.14.0252.15

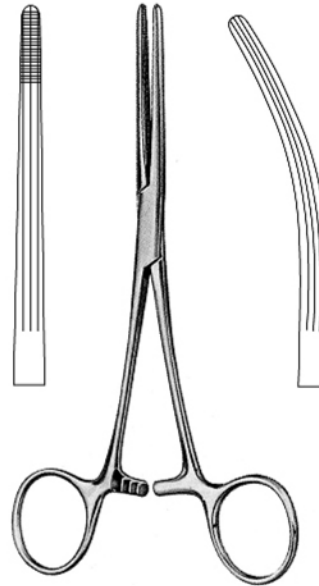

**ROCHESTER-CARMALT**

G14.14.0256.16 16.0cm G14.14.0257.16  
G14.14.0256.20 20.0cm G14.14.0257.20



**HOSEMANN**

G14.14.0260.21 21.0cm G14.14.0262.21 G14.14.0270.18 18.5cm G14.14.0271.18

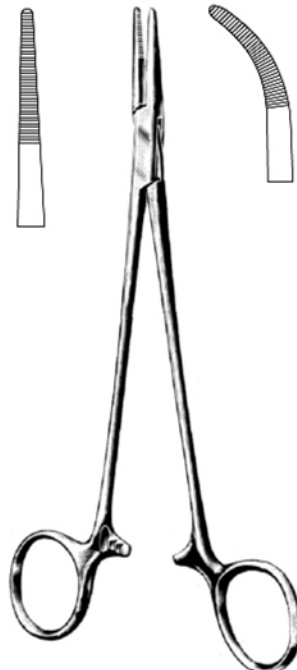

**ADSON**

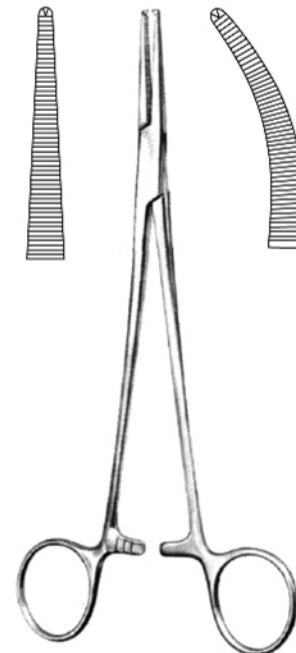

**ADSON**

G14.14.0272.18 18.5cm G14.14.0273.18

14.0273.18

**14-011**

[www.g14surgical.com](http://www.g14surgical.com)

EN Artery Forceps

DE Arterienklemmen

ES Pinzas hemostaticas



## ARTERY FORCEPS

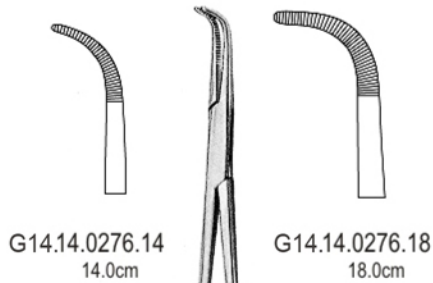

**BABY-ADSON**

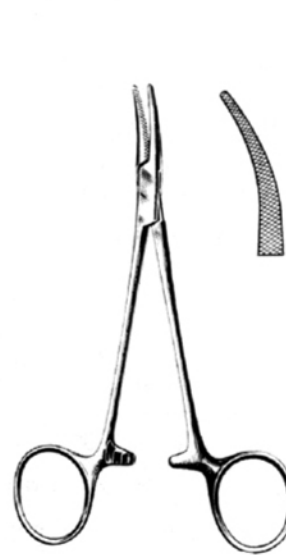

**BABY-OVERHOLT**

G14.14.0290.13 13.5cm

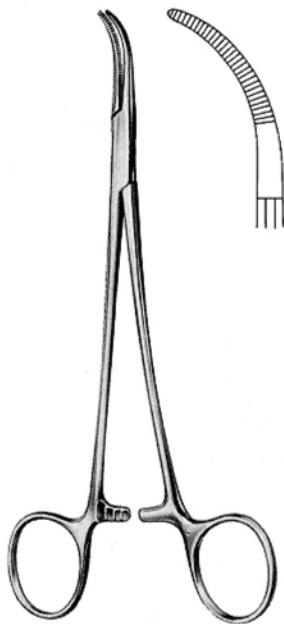

**MIXTER BABY**

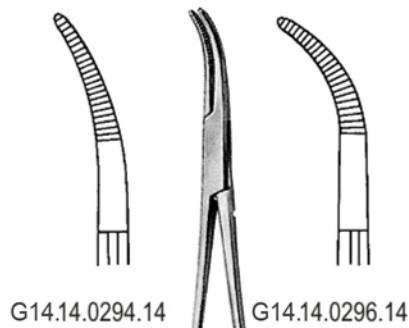

**BABY-MIXTER**

14.0cm

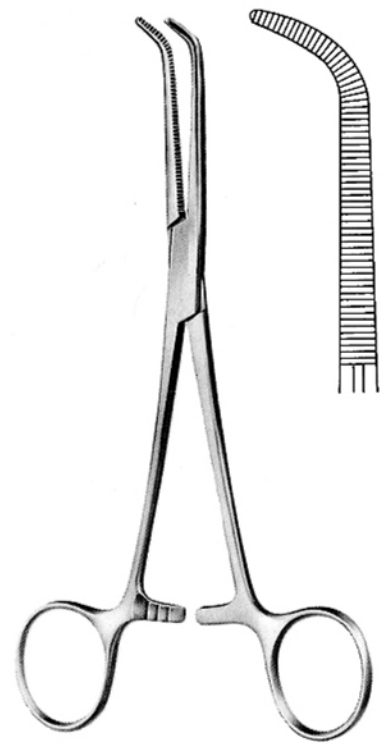

**BABY-MIXTER**

18.0cm

14.0298.18

**14-012**

[www.g14surgicals.com](http://www.g14surgicals.com)

## ARTERY FORCEPS

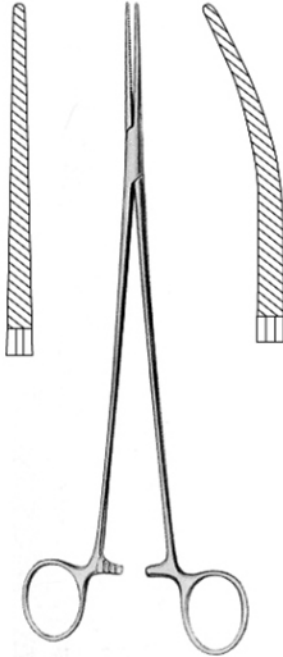

**BENGOLEA**

- |                |        |                |
|----------------|--------|----------------|
| G14.14.0300.20 | 20.0cm | G14.14.0301.20 |
| G14.14.0300.24 | 24.0cm | G14.14.0301.24 |
| G14.14.0300.26 | 26.0cm | G14.14.0301.26 |

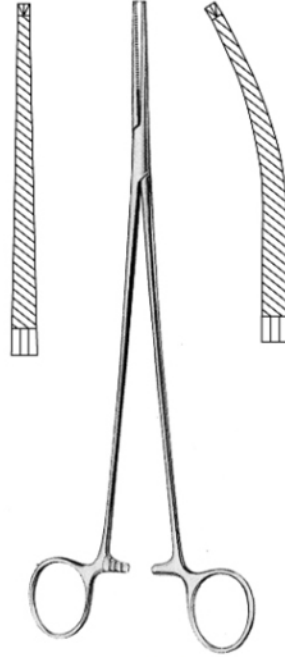

**BENGOLEA**

- |                |        |                |
|----------------|--------|----------------|
| G14.14.0302.20 | 20.0cm | G14.14.0303.20 |
| G14.14.0302.24 | 24.0cm | G14.14.0303.24 |
| G14.14.0302.26 | 26.0cm | G14.14.0303.26 |

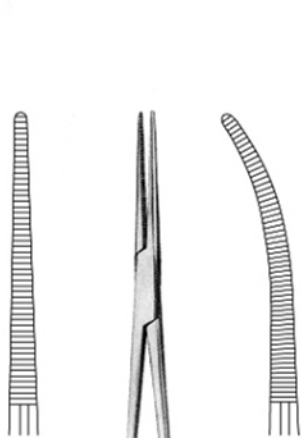

G14.14.0310.20

G14.14.0311.20



**HEISS**  
20.0cm

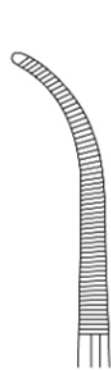

G14.14.0313.20

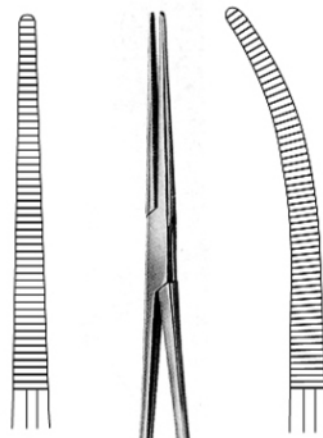

G14.14.0316.22

G14.14.0317.22



**ROBERTS**  
22.0cm

14.0317.22

**14-013**

[www.g14surgical.com](http://www.g14surgical.com)

# 14

EN Dissecting and ligature Forceps  
DE Präparier- und Ligaturklemmen  
ES Pinzas para preparaciones y ligaduras



## ARTERY FORCEPS

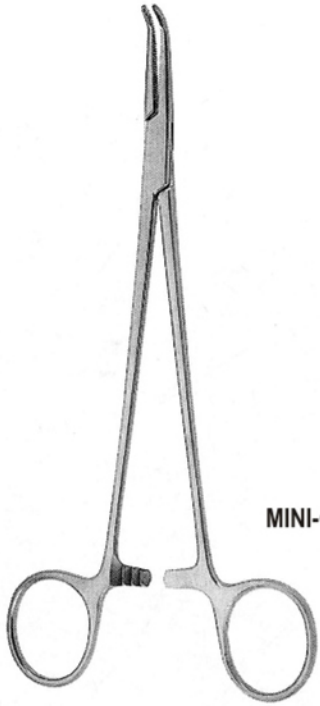

**MINI-GEMINI**

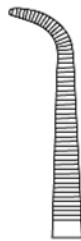

G14.14.0320.18  
18.0cm

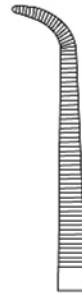

G14.14.0320.22  
22.0cm



G14.14.0320.25  
25.0cm



G14.14.0320.28  
28.0cm

**GEMINI**

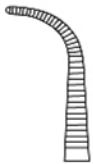

G14.14.0322.13  
13.0cm

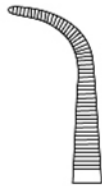

G14.14.0322.16  
16.0cm

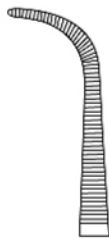

G14.14.0322.18  
18.0cm

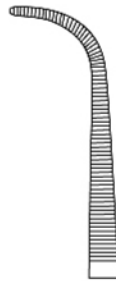

G14.14.0322.20  
20.0cm

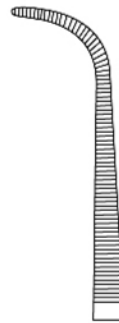

G14.14.0322.23  
23.0cm



G14.14.0322.25  
25.0cm

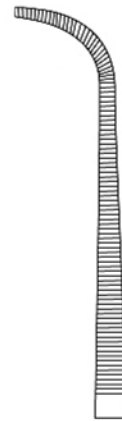

G14.14.0322.28  
28.0cm

14.0322.28

**14-014**

[www.g14surgicals.com](http://www.g14surgicals.com)

Artery Forceps EN

Arterienklemmen DE

Pinzas hemostaticas ES

14

ARTERY FORCEPS

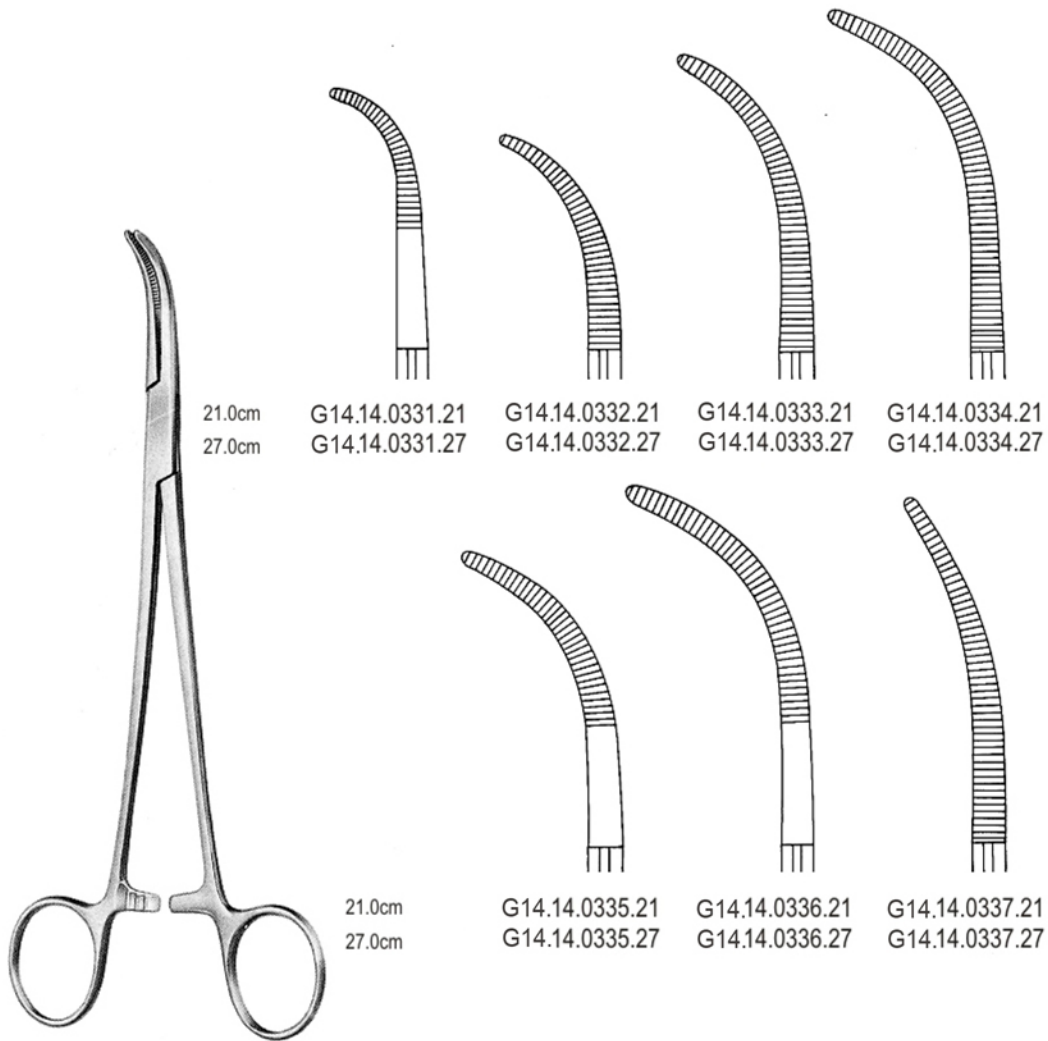

21.0cm  
27.0cm

G14.14.0331.21  
G14.14.0331.27

G14.14.0332.21  
G14.14.0332.27

G14.14.0333.21  
G14.14.0333.27

G14.14.0334.21  
G14.14.0334.27

21.0cm  
27.0cm

G14.14.0335.21  
G14.14.0335.27

G14.14.0336.21  
G14.14.0336.27

G14.14.0337.21  
G14.14.0337.27

OVERHOLT-GEISSENDOERFER

14.0337.27

14-015

www.g14surgical.com



## ARTERY FORCEPS



OVERHOLT

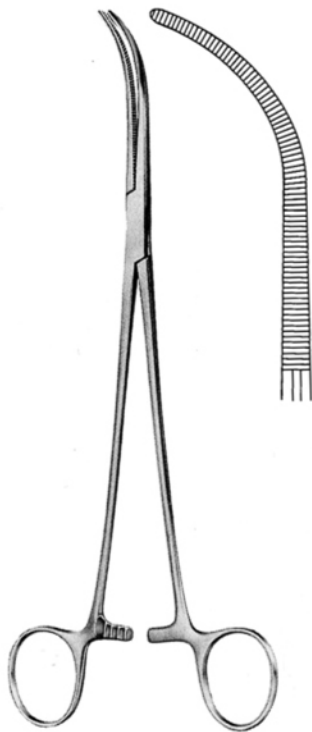
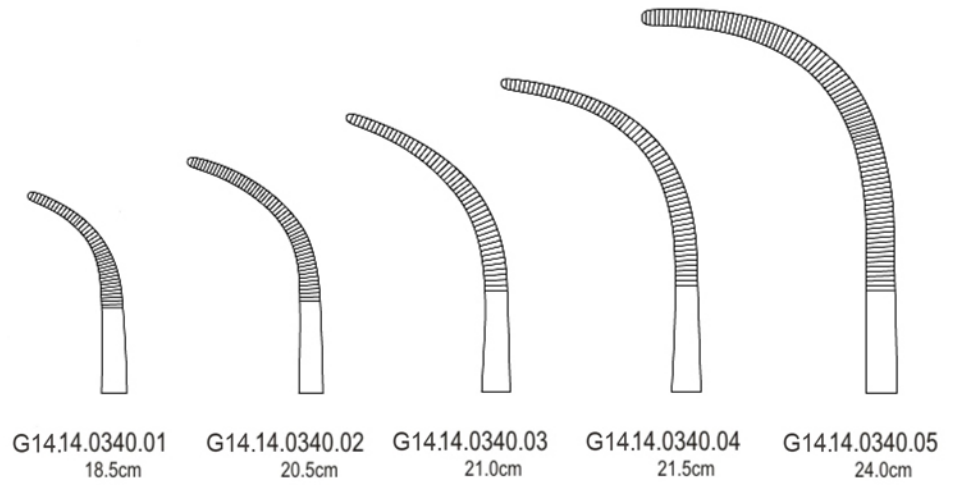

OVERHOLT-MIXER  
 G14.14.0342.21 21.0cm

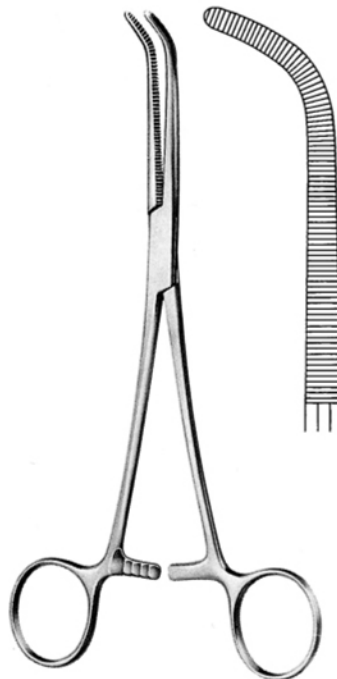

MIXER  
 G14.14.0344.22 22.0cm

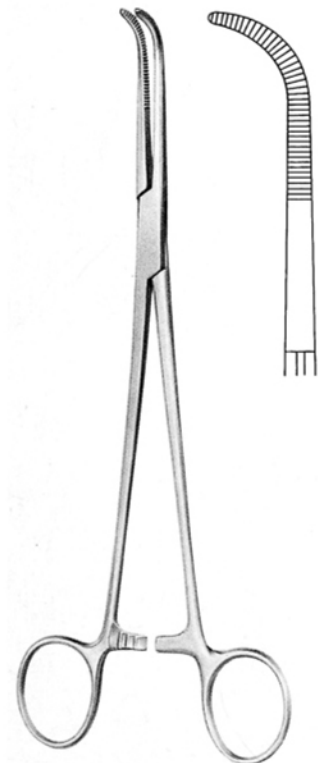

MIXER  
 G14.14.0346.23 23.0cm

14.0346.23

14-016

www.g14surgicals.com

ARTERY FORCEPS

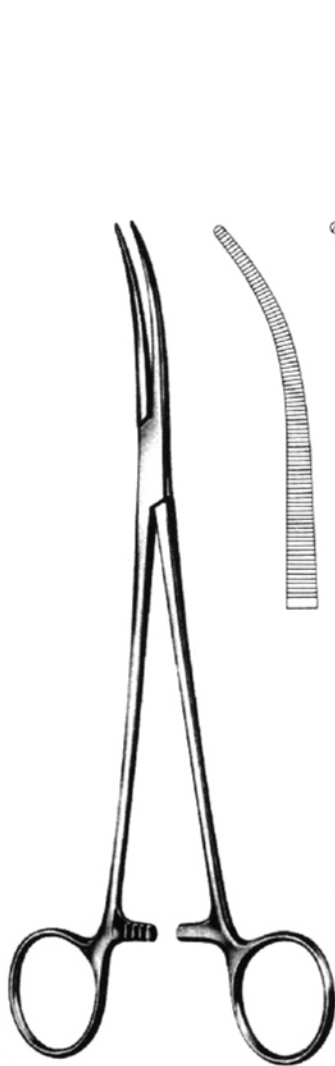

**KELLY**

19.0 cm G14.14.0350.19 G14.14.0351.19 G14.14.0353.19  
 22.0 cm G14.14.0350.22 G14.14.0351.22 G14.14.0353.22  
 24.0 cm G14.14.0350.24 G14.14.0351.24 G14.14.0353.24

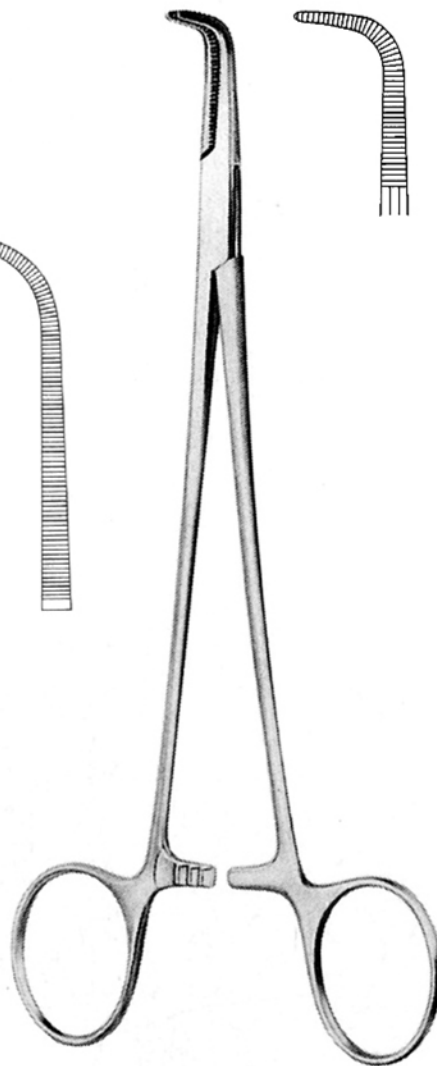

**MEEKER**

G14.14.0356.27 27.5 cm

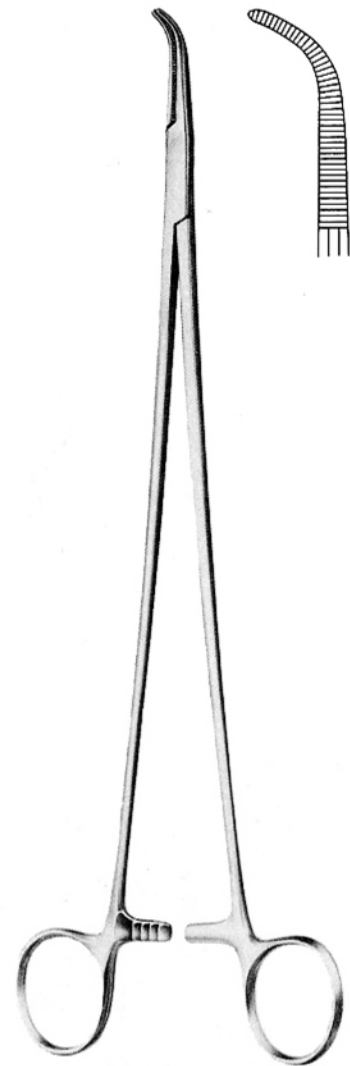

**LAWRENCE**

G14.14.0358.27 27.5 cm

14.0358.27

**14-017**

[www.g14surgical.com](http://www.g14surgical.com)

EN Artery Forceps, Dissecting Forceps

DE Arterienklemmen, Parparier

ES Pinzas hemostaticas, pinzas para preparaciones



## ARTERY FORCEPS

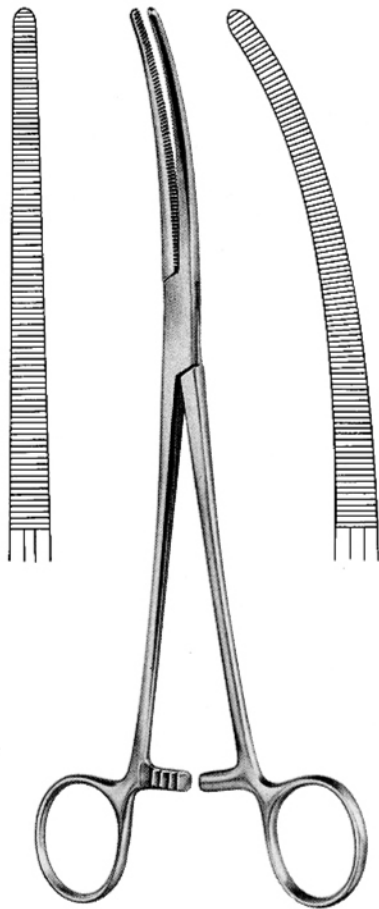

**SAROT**

G14.14.0360.24 24.0cm G14.14.0361.24

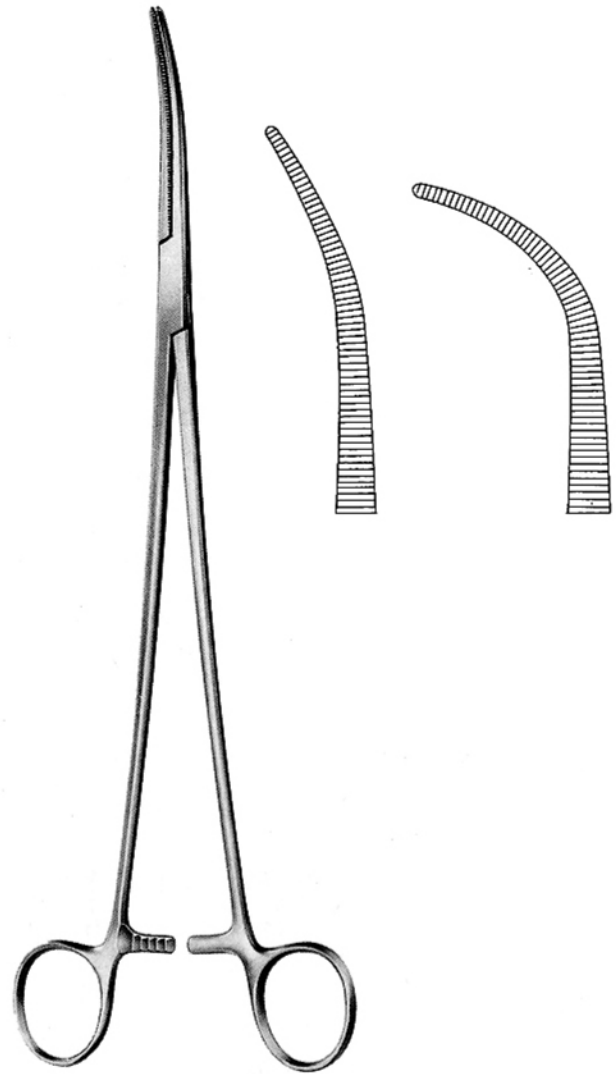

**ZENKER**

G14.14.0366.01 29.5cm G14.14.0366.02

14.0366.02

**14-018**

[www.g14surgicals.com](http://www.g14surgicals.com)

ARTERY FORCEPS

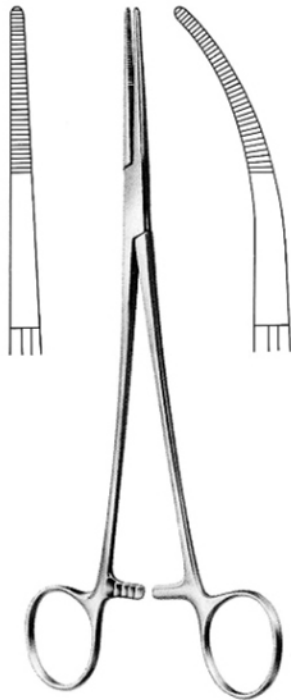

**TOENNIS**  
 G14.14.0371.21  
 G14.14.0371.26

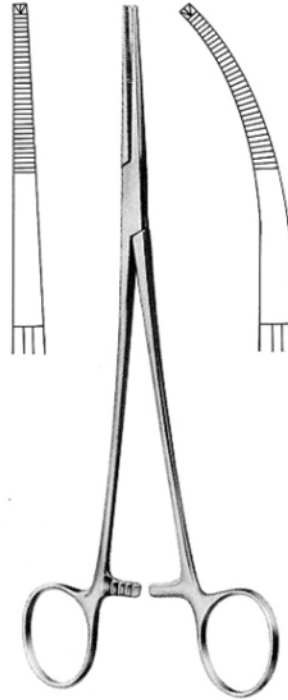

**TOENNIS**  
 G14.14.0373.21  
 G14.14.0373.26



**RUMEL**  
 23.0cm

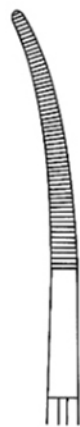

G14.14.0380.01



G14.14.0380.03



G14.14.0380.04

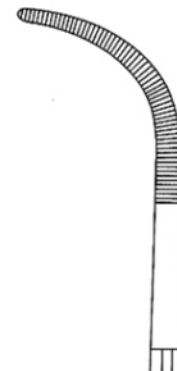

G14.14.0380.05

14.0380.05

**14-019**

[www.g14surgical.com](http://www.g14surgical.com)

EN Artery Forceps, Dissecting and Ligature Forceps

DE Arterienklemmen, Präparier- und Ligaturklemmen

ES Pinzas hemostáticas, pinzas para preparaciones y ligaduras



## ARTERY FORCEPS

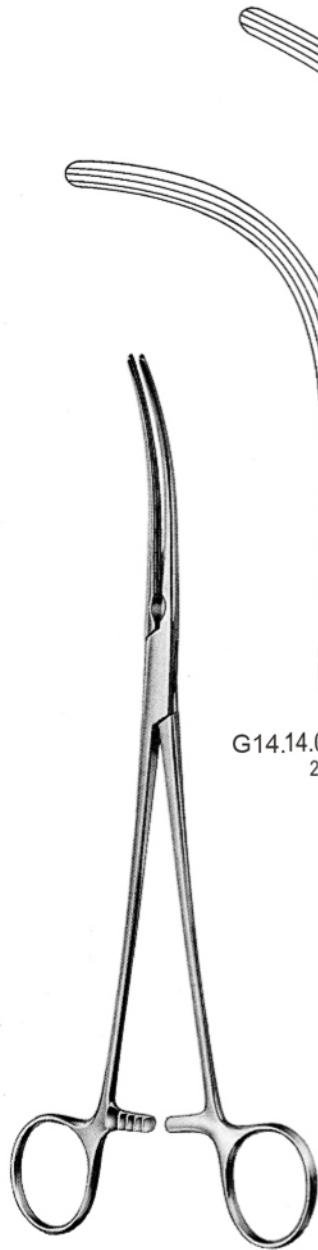

CRAFOORD-SELLORS

G14.14.0386.01  
22.0cm

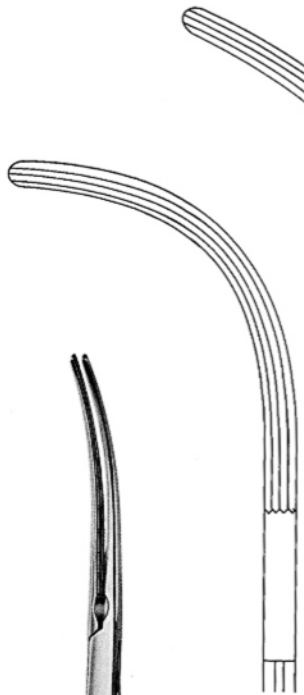

G14.14.0386.02  
23.0cm



G14.14.0386.03  
24.0cm

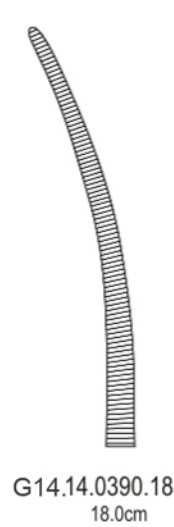

G14.14.0390.18  
18.0cm

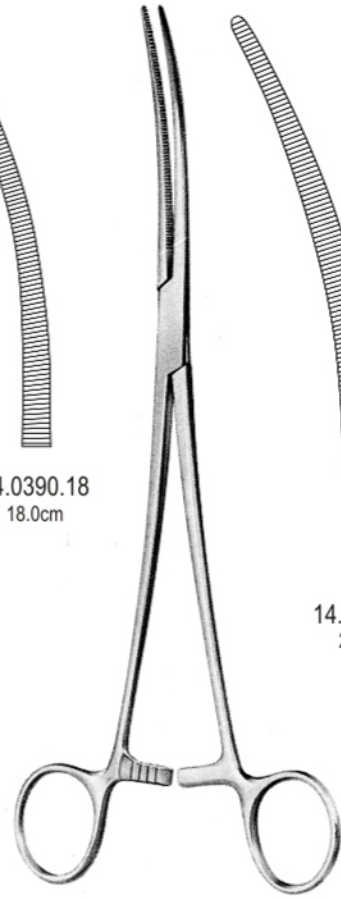

CRAFOORD

14.0390.24  
24.0cm

14.0390.24

14-020

www.g14surgicals.com

ARTERY FORCEPS

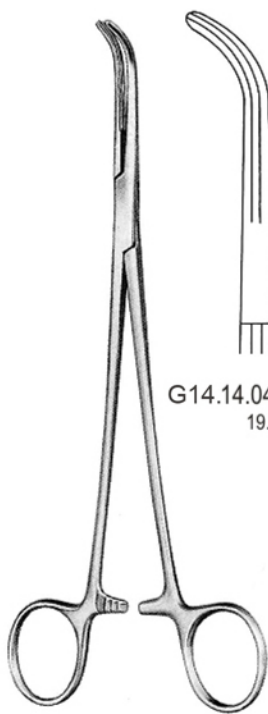

G14.14.0400.19 19.0cm G14.14.0400.23 23.0cm

LAHEY

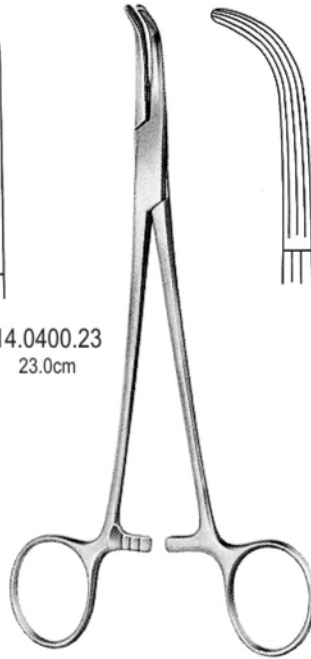

LOWER G14.14.0406.18 18.0cm

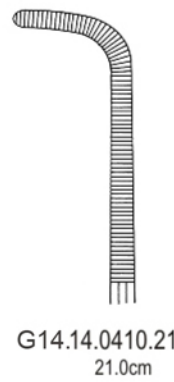

G14.14.0410.21 21.0cm

WICKSTRÖM

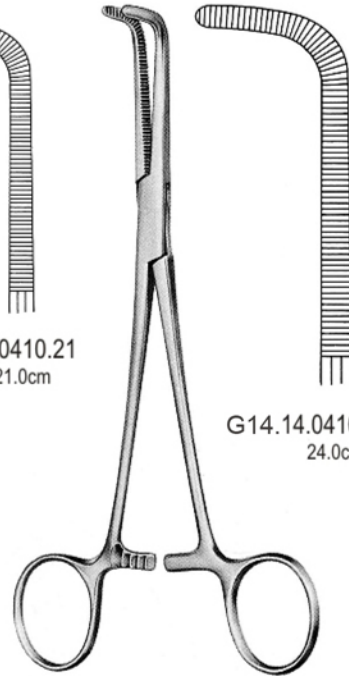

G14.14.0410.24 24.0cm

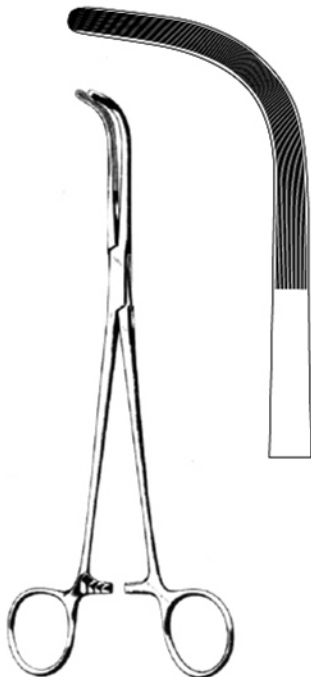

McQUIGG-MIXTER G14.14.0416.22 22.0cm



FINOCHIETTO G14.14.0420.24 24.0cm

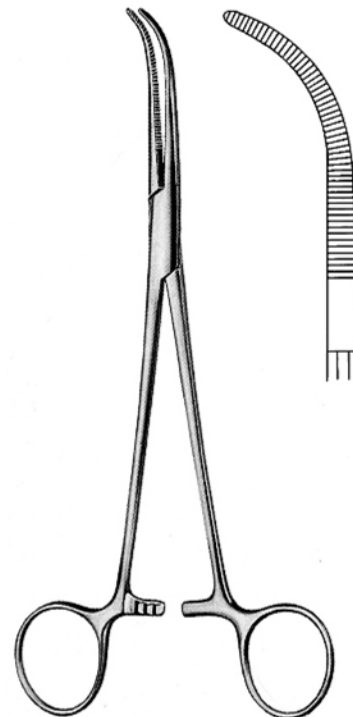

JOHNS HOPKINS G14.14.0426.20 20.0cm

14.0426.20

14-021

www.g14surgical.com

EN Artery Forceps, Gall Duct and Kidney Pedical Clamp Forceps

DE Arterien-Gallenkanal-und Nierenstielklemmen

ES Pinzas-gallenkanal-und nierenstielklemmen



## ARTERY FORCEPS

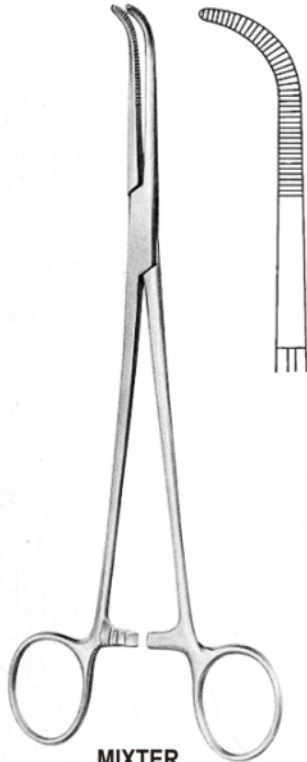

**MIXTER**

G14.14.0430.15 15.0cm  
G14.14.0430.19 19.0cm

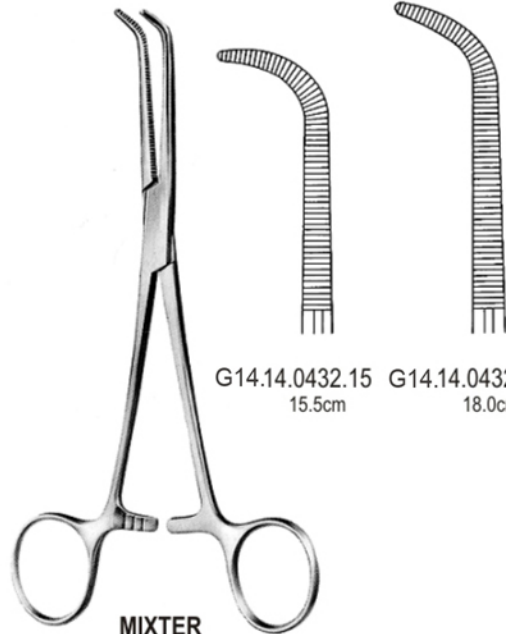

**MIXTER**

G14.14.0432.15 15.5cm  
G14.14.0432.18 18.0cm

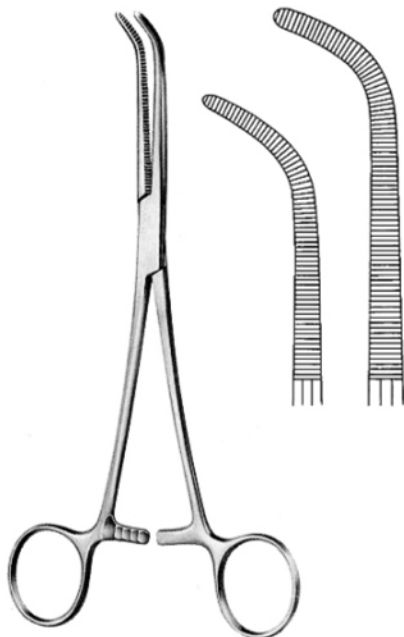

**MIXTER-O'SHAUGHNESSY**

G14.14.0434.18 18.0cm  
G14.14.0434.22 22.0cm

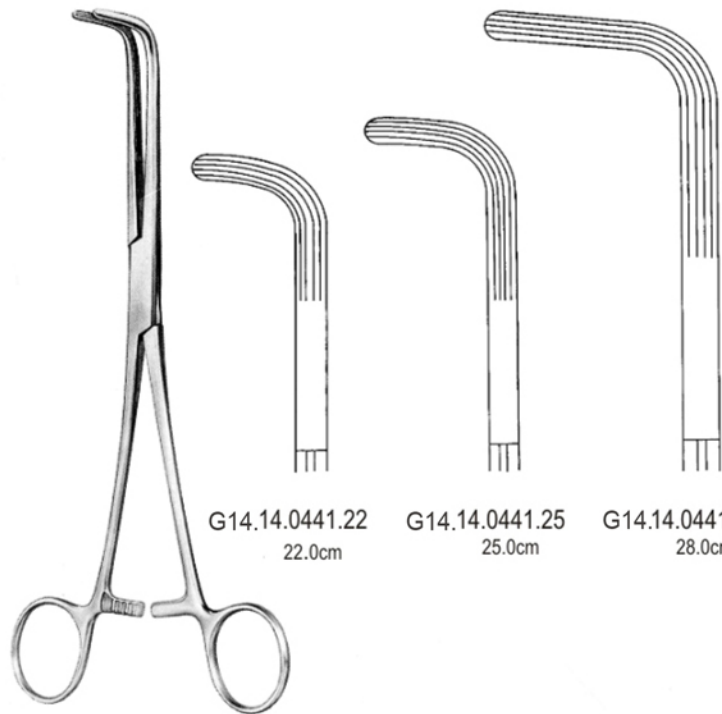

**MIXTER**

G14.14.0441.22 22.0cm  
G14.14.0441.25 25.0cm  
G14.14.0441.28 28.0cm

14.0441.28

**14-022**

www.g14surgical.com

ARTERY FORCEPS

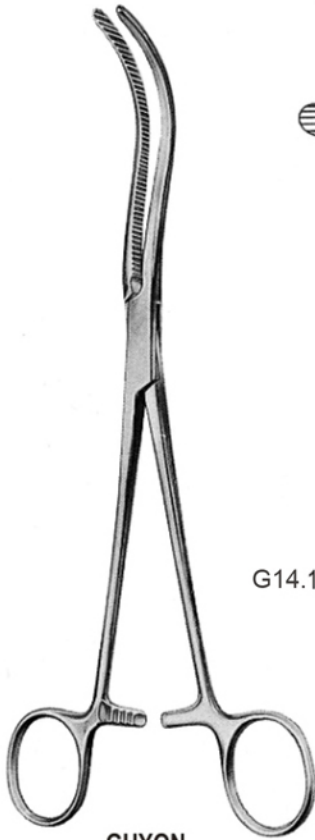

GUYON

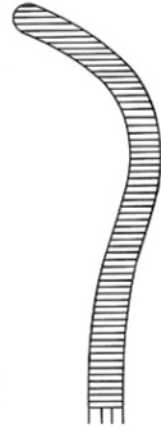

G14.14.0450.20 20.0cm

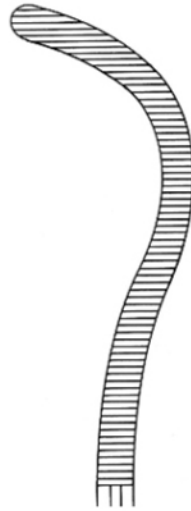

G14.14.0450.22 22.0cm



G14.14.0450.24 24.0cm

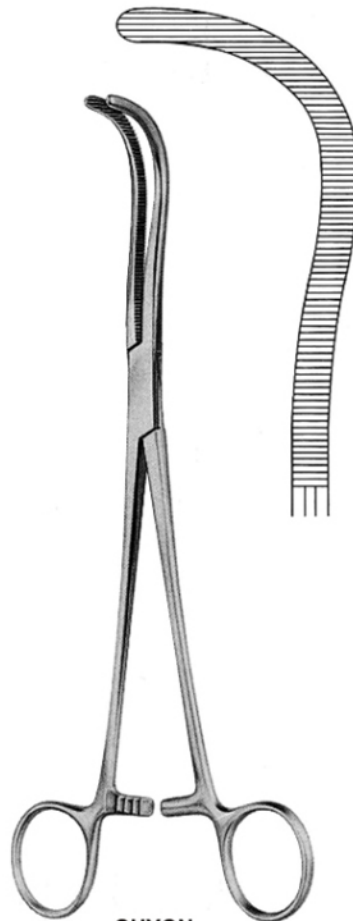

GUYON

G14.14.0452.23 23.0cm

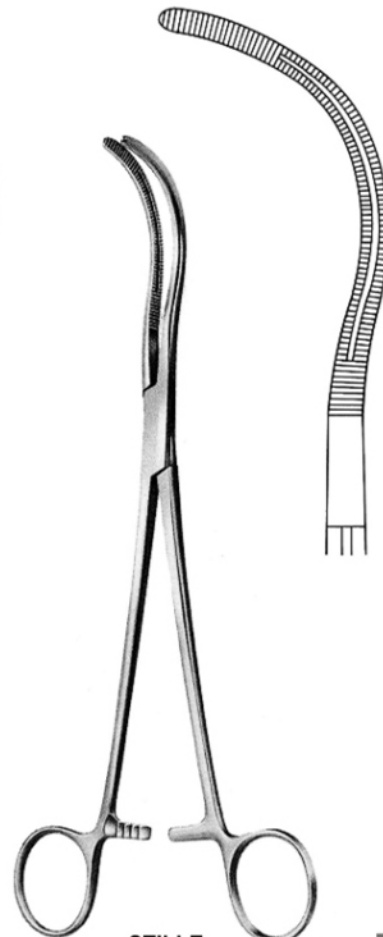

STILLE

G14.14.0454.23 23.0cm

14.0454.23

14-023

www.g14surgical.com

# 14

- EN Kidney Pedicle Clamps
- DE Nierenstielklemmen
- ES Pinzas clamps para pedunculos renales



## ARTERY FORCEPS

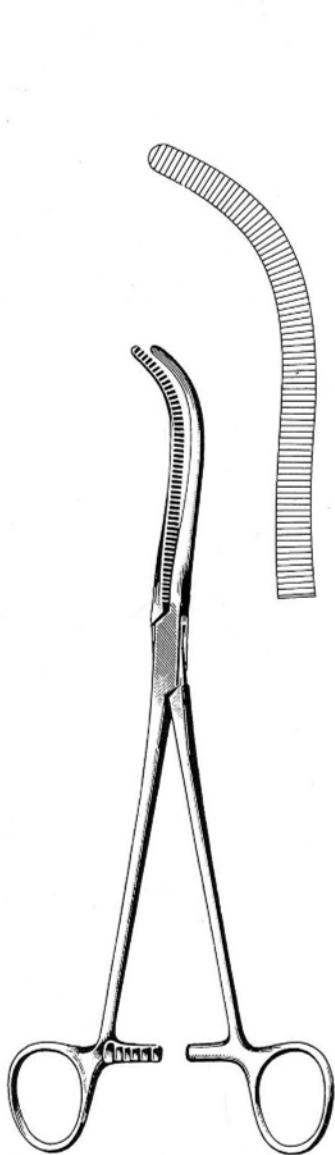

**MAYO**  
G14.14.0456.23 23.0cm

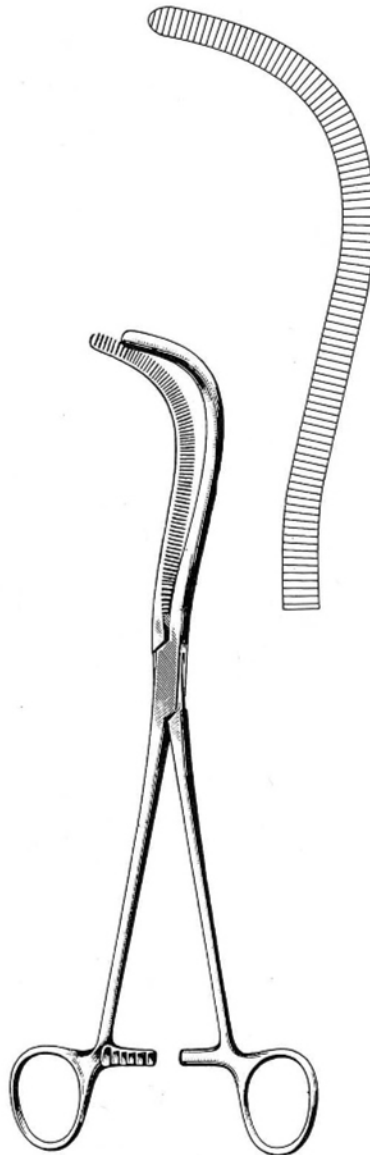

**MAYO-GUYON**  
G14.14.0458.23 23.0cm

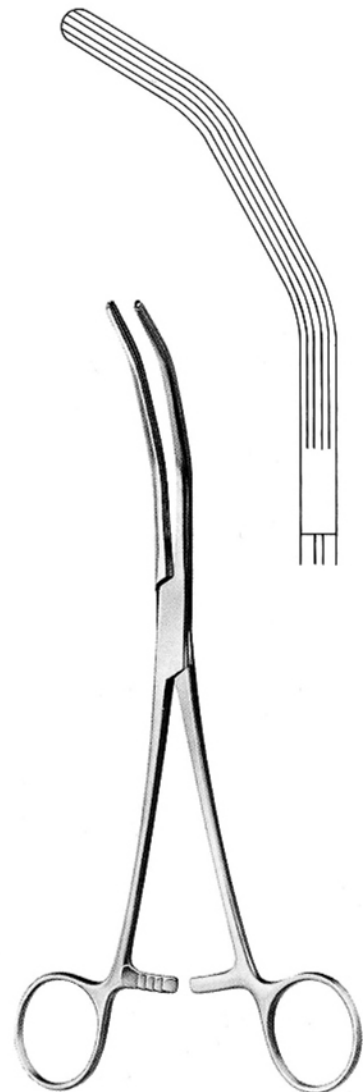

**MAYO-GUYON**  
G14.14.0460.23 23.0cm

14.0460.23

**14-024**

[www.g14surgical.com](http://www.g14surgical.com)

ARTERY FORCEPS

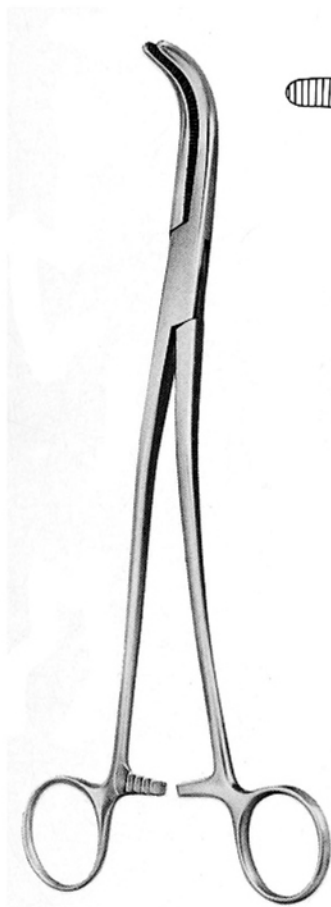

GRAY

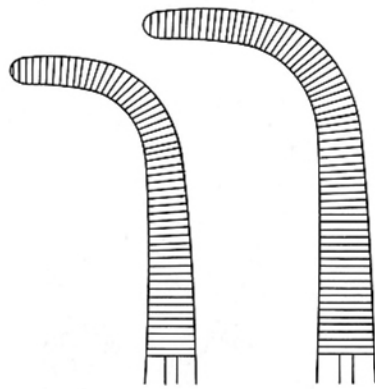

G14.14.0464.22 22.0cm  
G14.14.0464.23 23.0cm

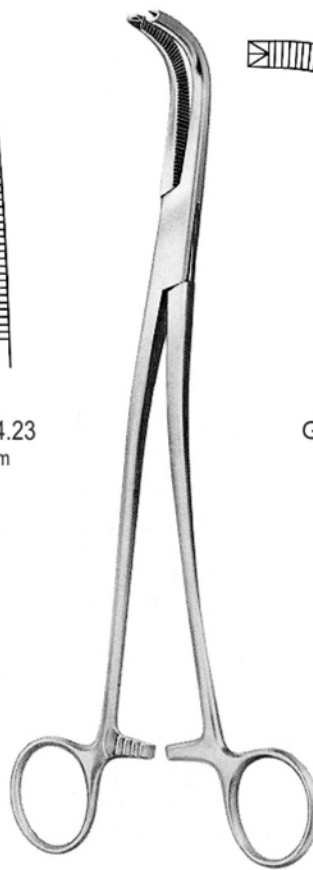

GRAY

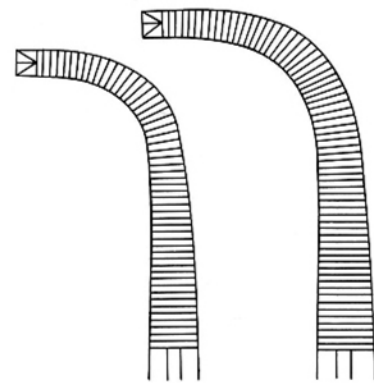

G14.14.0468.22 22.0cm  
14.0468.23 23.0cm

14.0468.23

14-025

www.g14surgical.com

## ARTERY FORCEPS



**DESJARDINS**  
 G14.14.0470.21 21.0cm

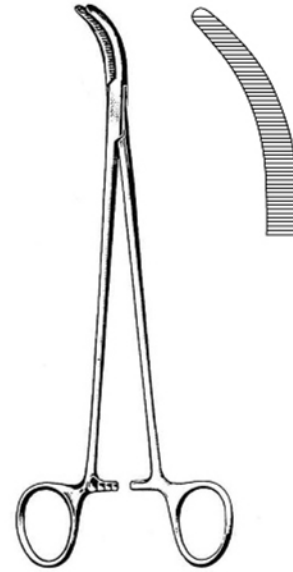

**DESJARDINS**  
 G14.14.0472.21 21.0cm

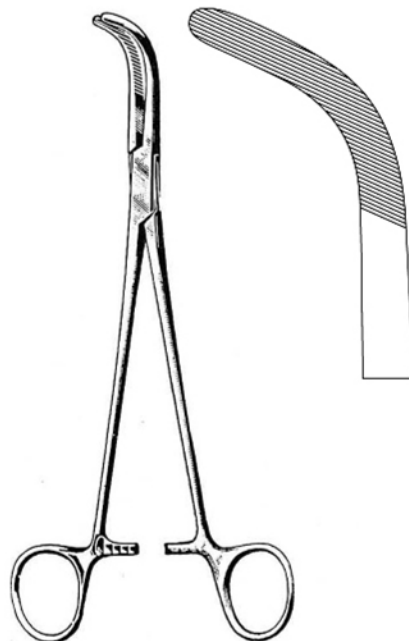

**CRILE**  
 G14.14.0476.20 20.0cm



**DEAN-SHALLCROSS**  
 G14.14.0480.18 18.0cm

14.0480.18

**14-026**

[www.g14surgical.com](http://www.g14surgical.com)

ATRAUMA

ARTERY FORCEPS

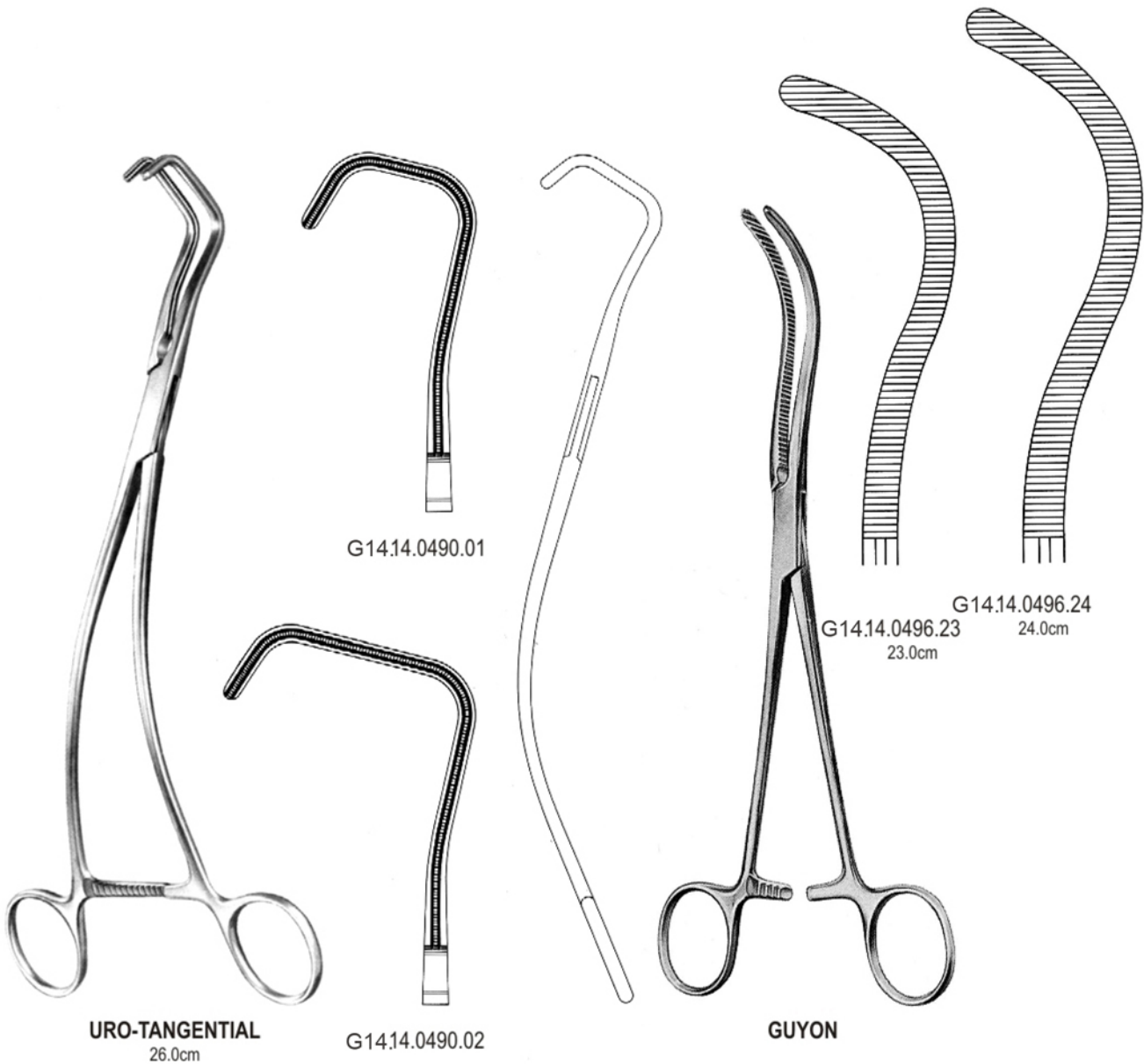

14.0496.24

14-027

www.g14surgical.com

## ARTERY FORCEPS



**BABY-MIKULICZ**  
 G14.14.0500.14 14.0cm

**MIKULICZ**  
 G14.14.0500.18 18.0cm

**MIKULICZ**  
 G14.14.0500.20 20.0cm

**MIKULICZ**  
 G14.14.0502.20 20.0cm

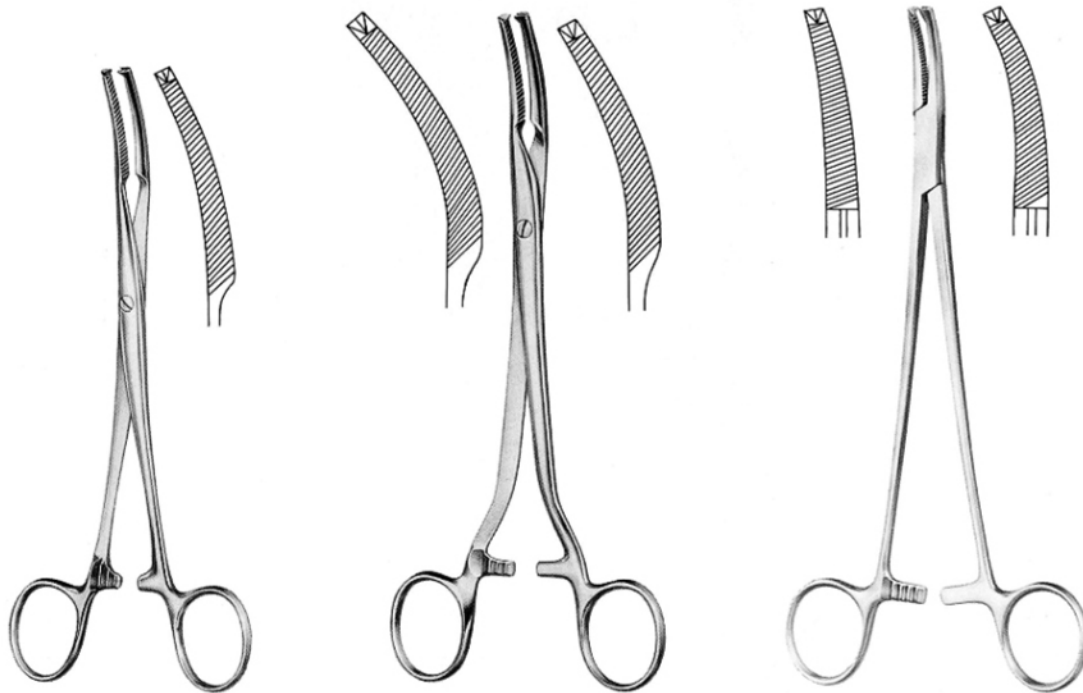

**MIKULICZ**  
 14.0514.20 G14.14.0504.18 18.0cm

**MIKULICZ**  
 G14.14.0506.20 20.0cm  
 G14.14.0508.20

**FAURE**  
 G14.14.0512.20 20.0cm  
 G14.14.0514.20

Hysterectomy Forceps EN

Hysterektomieklemmen DE

Pinzas Para Histerectomia ES

14

ARTERY FORCEPS

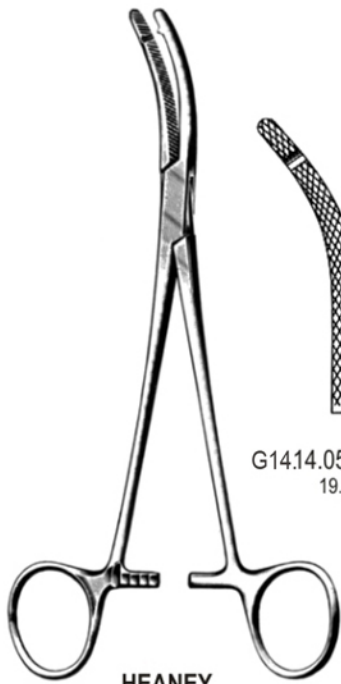

HEANEY

G14.14.0520.19  
19.5cm

G14.14.0520.21  
21.0cm

G14.14.0520.23  
23.0cm

G14.14.0522.19  
19.5cm

G14.14.0522.21  
21.0cm

G14.14.0522.23  
23.0cm

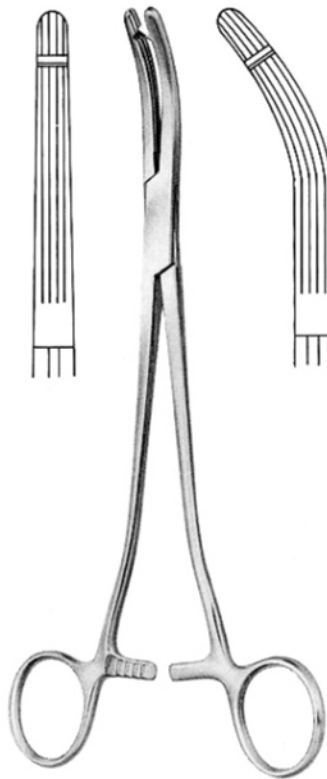

HEANEY-BALLENTINE

G14.14.0526.21 21.0cm  
G14.14.0527.21

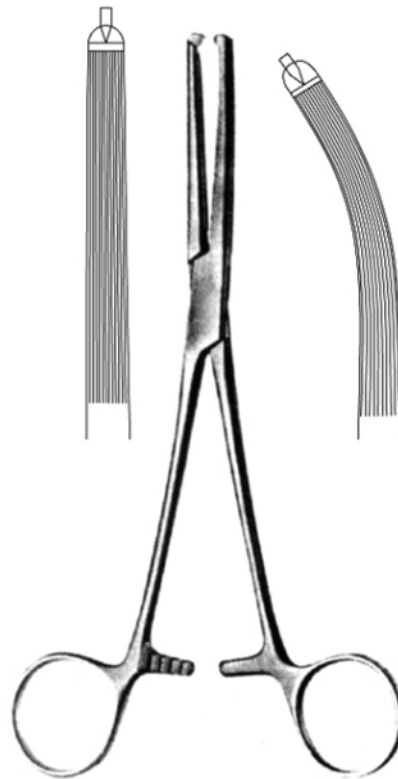

Gwilliam

G14.14.0530.20 20.0cm  
G14.14.0531.20

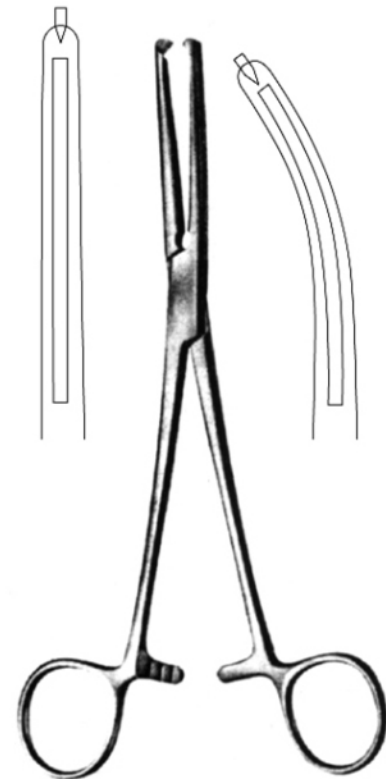

MAINGOT

G14.14.0536.20 20.0cm  
G14.14.0537.20

14.0537.20

14-029

www.g14surgical.com

## ARTERY FORCEPS

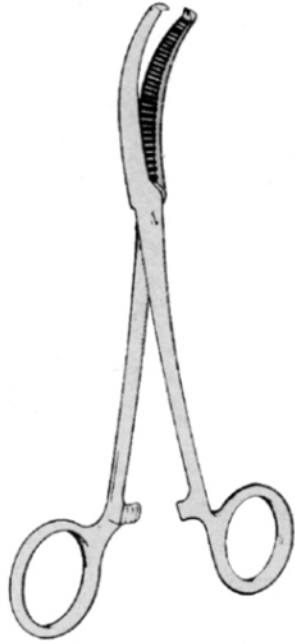

**BERKELEY**  
 G14.14.0540.20 20.0 cm



**BERKELEY BONNEY**  
 G14.14.0544.19 19.0 cm

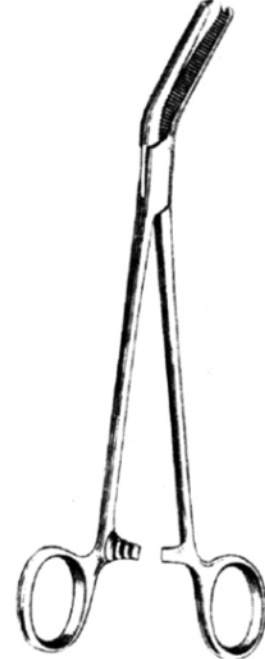

**BONNEY**  
 G14.14.0548.20 20.5 cm

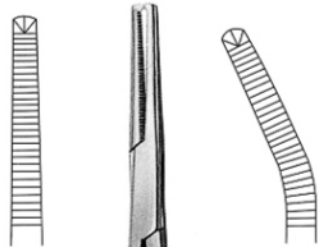

G14.14.0550.21

G14.14.0551.21

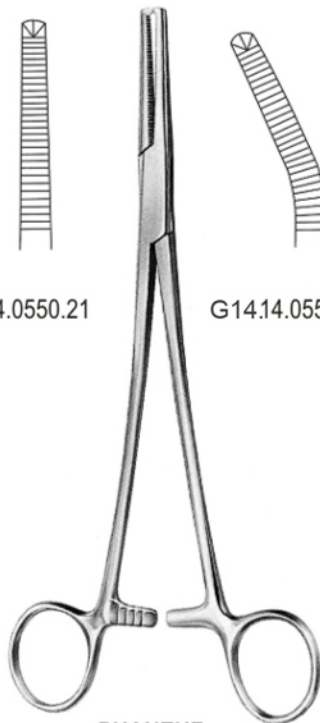

**PHANEUF**  
 21.0cm

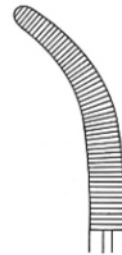

G14.14.0556.23  
 23.0 cm

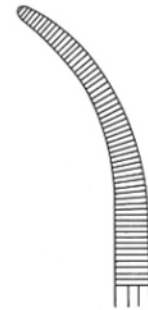

G14.14.0556.24  
 24.0 cm

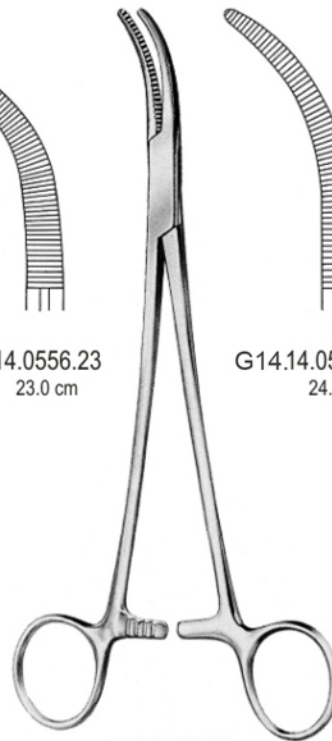

**MOYNIHAN**

ARTERY FORCEPS



G14.14.0560.22  
22.0cm

G14.14.0560.23  
23.0cm

WERTHEIM

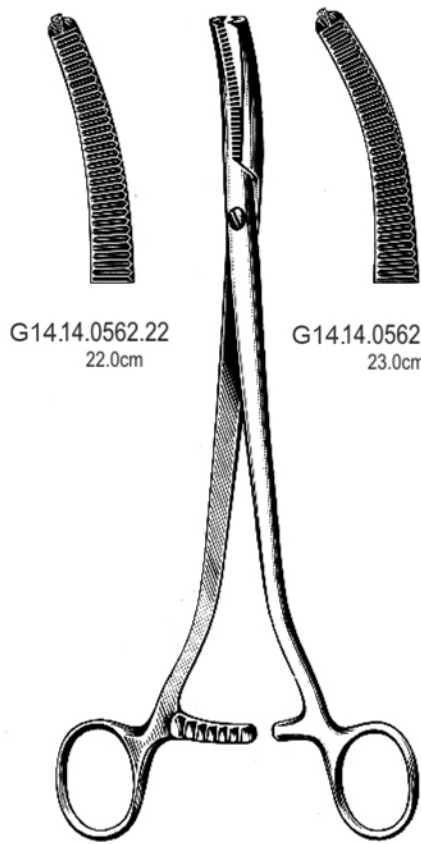

G14.14.0562.22  
22.0cm

G14.14.0562.23  
23.0cm

WERTHEIM



G14.14.0566.24  
24.0cm

WERTHEIM

14.0566.24

14-031

www.g14surgical.com

14

EN Hysterectomy Forceps

DE Hysterektomieklemmen

ES Pinzas para histerectomia



## ARTERY FORCEPS

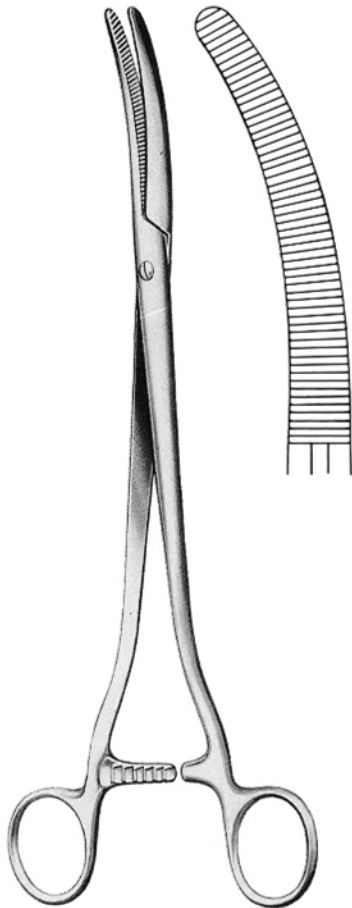

**FAURE**

G14.14.0570.25 25.0cm

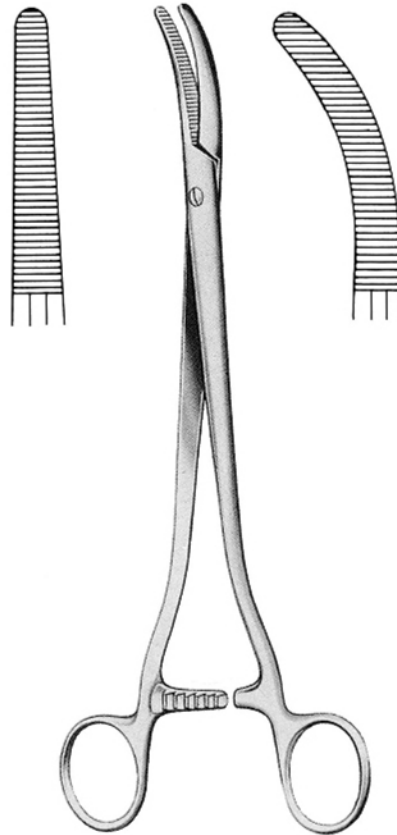

**SEGOND-LANDAU**

G14.14.0576.24 24.0cm 14.0577.24

14.0577.24

**14-032**

[www.g14surgical.com](http://www.g14surgical.com)

ARTERY FORCEPS

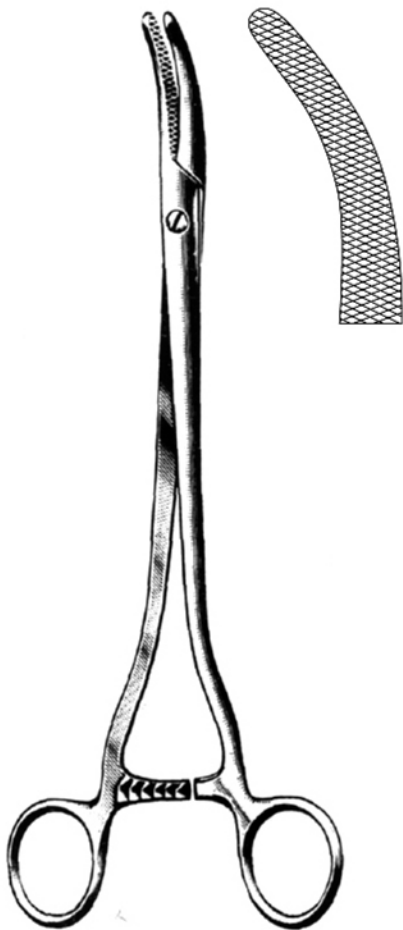

**WERTHEIM**  
G14.14.0580.25 25.0cm

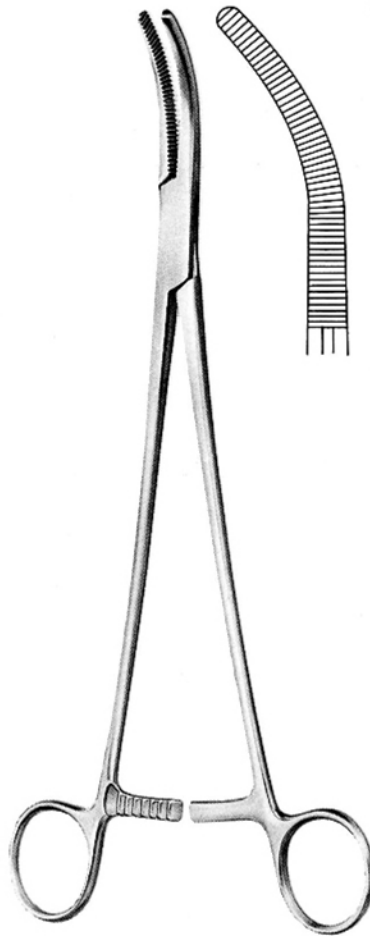

**WERTHEIM**  
G14.14.0582.25 25.0cm



**WERTHEIM-CULLEN**  
G14.14.0586.21 21.5cm

14.0586.21

**14-033**

[www.g14surgical.com](http://www.g14surgical.com)



## ARTERY FORCEPS

ATRAUMA

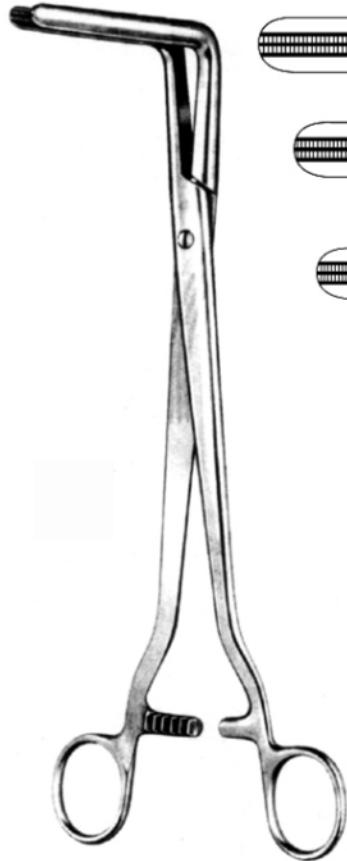

WERTHEIM  
24.0cm

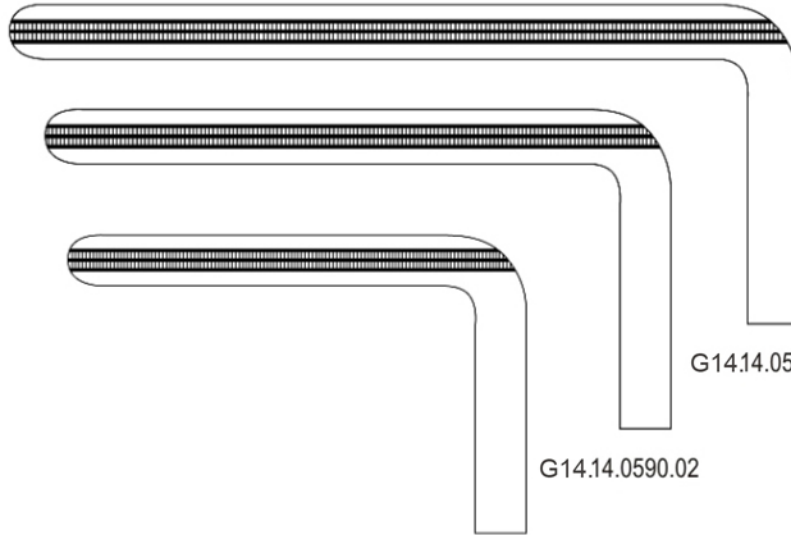

G14.14.0590.01

G14.14.0590.02

G14.14.0590.03

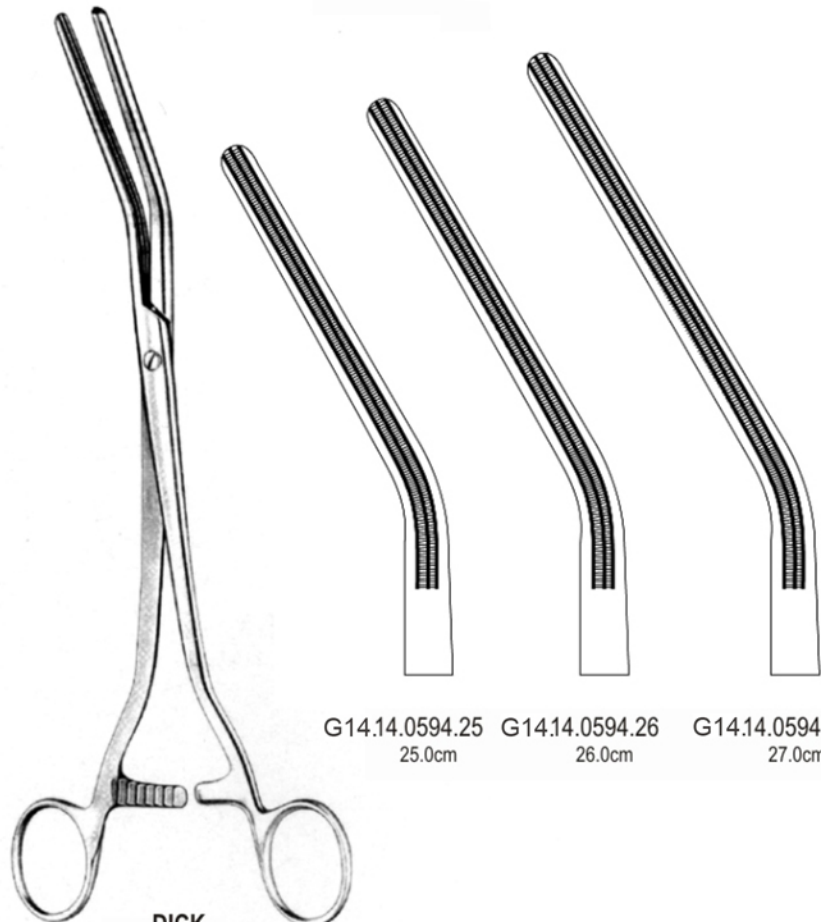

DICK

G14.14.0594.25  
25.0cm

G14.14.0594.26  
26.0cm

G14.14.0594.27  
27.0cm

14.0594.27

14-034

www.g14surgical.com

ATRAUMA

ARTERY FORCEPS



14.0602.04

14-035

www.g14surgical.com



## ARTERY FORCEPS



**MARTEL**  
G14.14.0620.14 14.0cm



**PRATT**  
G14.14.0624.15 15.0cm

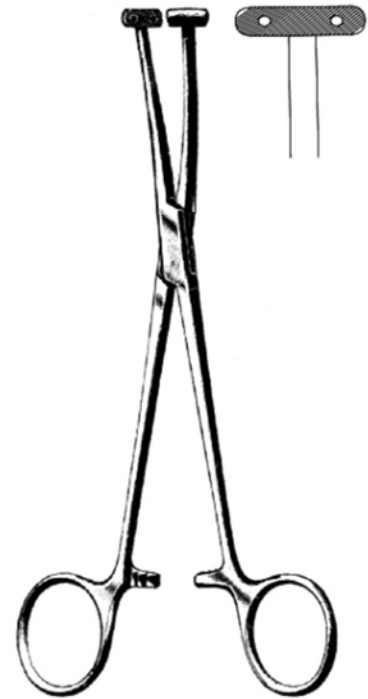

**WILLET-MARTEL**  
G14.14.0628.19 19.0cm

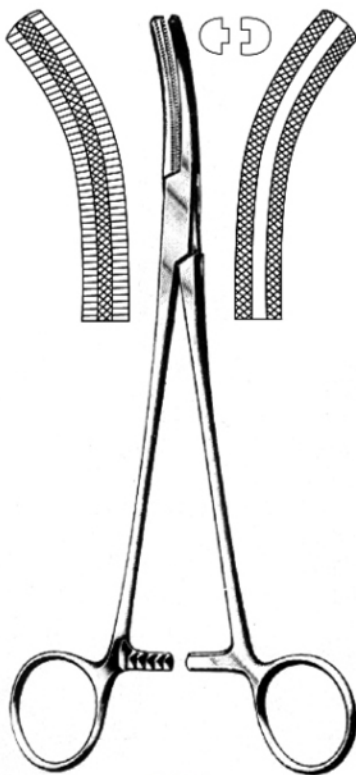

**BUIE**  
G14.14.0630.21 21.0cm



**FERGUSSON**

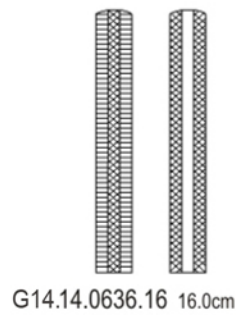

G14.14.0636.16 16.0cm

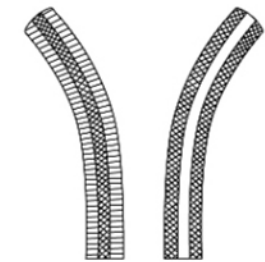

G14.14.0637.16 16.0cm

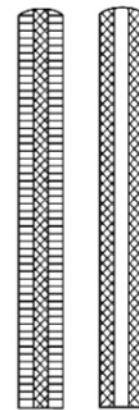

G14.14.0636.20 20.0cm

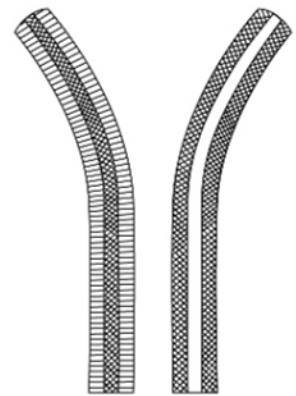

G14.14.0637.20 20.0cm

14.0637.20

**14-036**

www.g14surgical.com

ARTERY FORCEPS

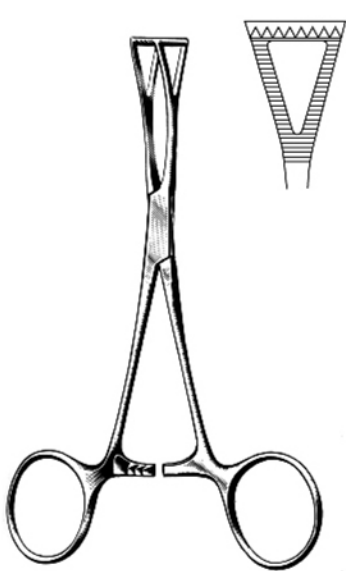

**COLLIN**  
 G14.14.0640.14 14.0cm

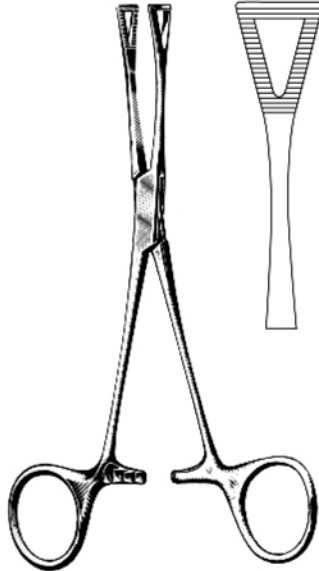

**PENNINGTON**  
 G14.14.0646.15 15.5cm  
 G14.14.0646.20 20.0cm

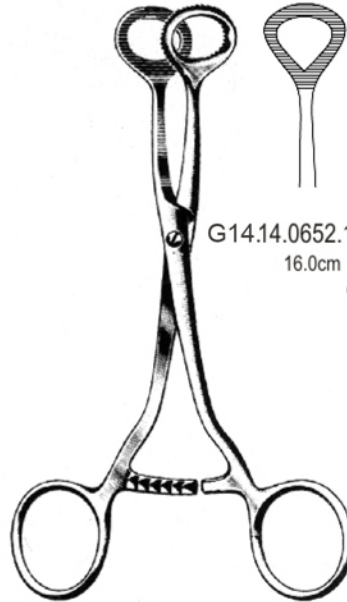

**COLLIN**  
 G14.14.0650.16 16.0cm



G14.14.0652.16  
 16.0cm

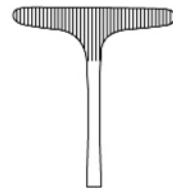

G14.14.0654.16  
 16.0cm



G14.14.0656.16  
 16.0cm

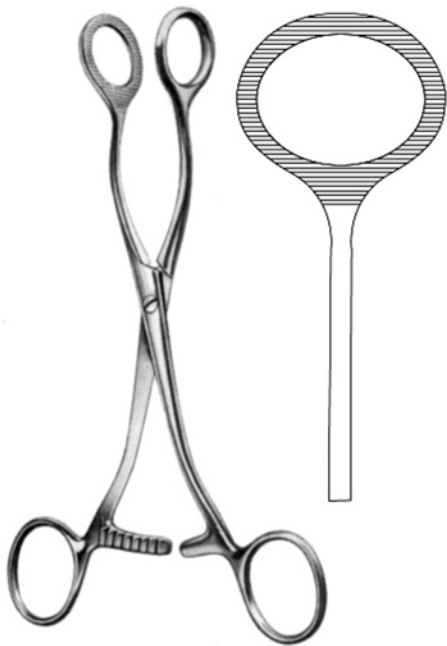

**COLLIN**  
 G14.14.0658.16 16.5cm

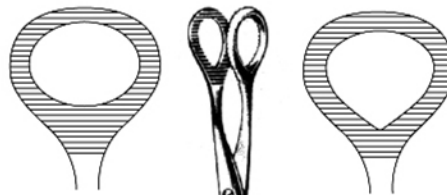

**PEAN**  
 G14.14.0660.12 12.0cm  
 G14.14.0662.12



**HOPFNER**  
 G14.14.0666.16 16.0cm

14.0666.16

14-037

www.g14surgical.com

EN Tissue and Organ Holding Forceps

DE Gewebe-und Organ Faßzangen

ES Pinzas para tejidos y organos



## ARTERY FORCEPS

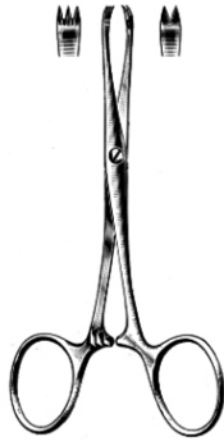

**CHAPUT**  
G14.14.0670.13 13.0cm

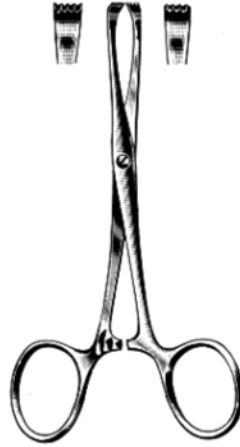

**TUFFIER**  
G14.14.0674.13 13.0cm

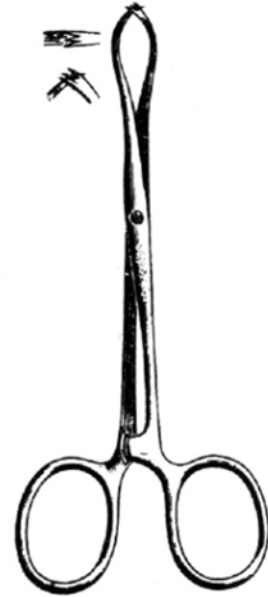

**PORRIER**  
G14.14.0678.12 12.5cm  
G14.14.0678.18 18.0cm



**LANE**  
G14.14.0680.12 12.5cm  
G14.14.0680.15 15.0cm  
G14.14.0680.19 19.5cm



**LANE**  
G14.14.0682.12 12.5cm  
G14.14.0682.15 15.0cm  
G14.14.0682.20 20.0cm



**ATRAUMA**



G14.14.0686.25 25.0cm



G14.14.0688.26 26.0cm

14.0688.26

**14-038**

www.g14surgicals.com

Tubing Clamp EN

Schlauchklemmen DE

Pinzas para tubos ES

# 14

## ARTERY FORCEPS

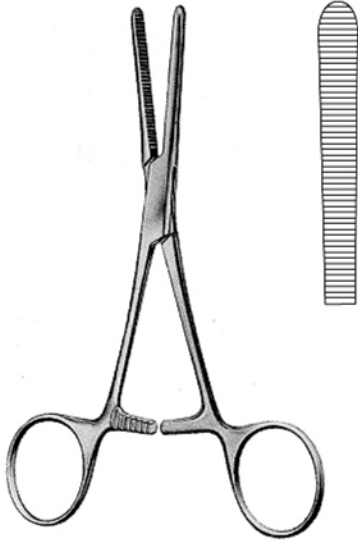

G14.14.0690.14 14.5cm

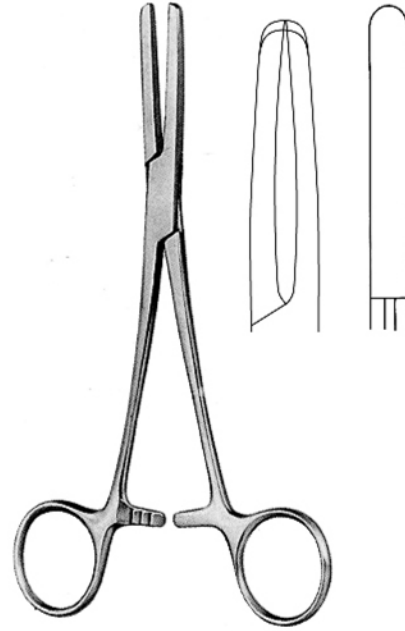

G14.14.0692.16 16.5cm  
G14.14.0692.18 18.0cm  
G14.14.0692.20 20.0cm

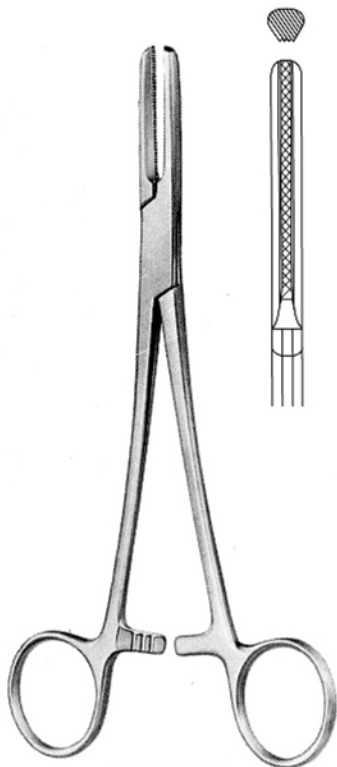

### STANDARD

G14.14.0700.15 15.0cm  
G14.14.0700.18 18.0cm  
G14.14.0700.20 20.0cm

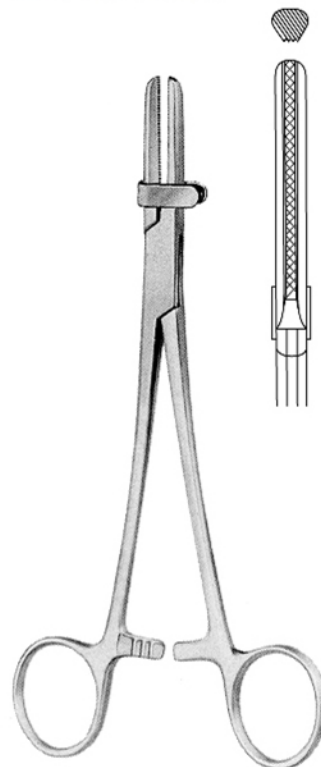

G14.14.0702.15 15.0cm  
G14.14.0702.16 16.5cm  
G14.14.0702.18 18.0cm  
G14.14.0702.20 20.0cm

14.0702.20

**14-039**

[www.g14surgical.com](http://www.g14surgical.com)

EN Towel Clamps

DE Tuchklemmen

ES Pinzas para compresas, pinzas de campo



## ARTERY FORCEPS



**LORNA**

G14.14.0710.10 10.0cm  
G14.14.0710.13 13.0cm

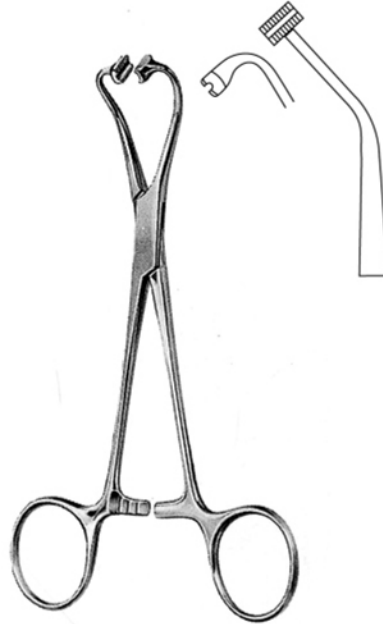

**PEERS-BERTRAM**

G14.14.0714.14 14.5cm

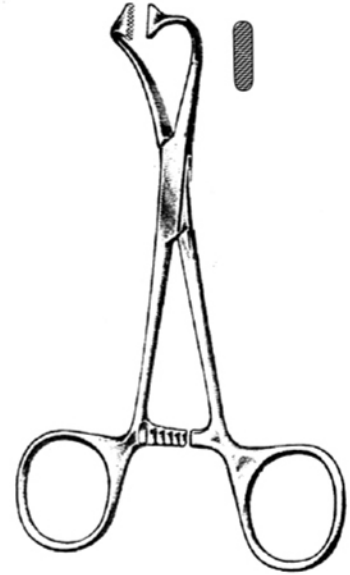

G14.14.0718.10 10.0cm  
G14.14.0718.13 13.0cm

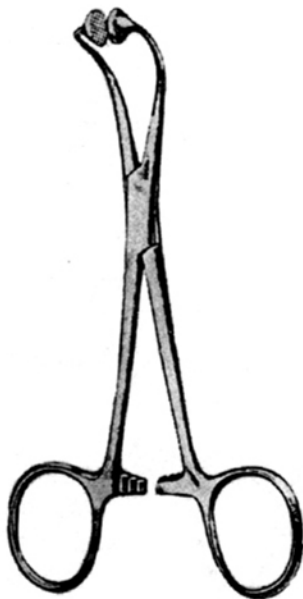

**HOFF (HOFER)**

G14.14.0720.10 10.0cm  
G14.14.0720.14 14.5cm

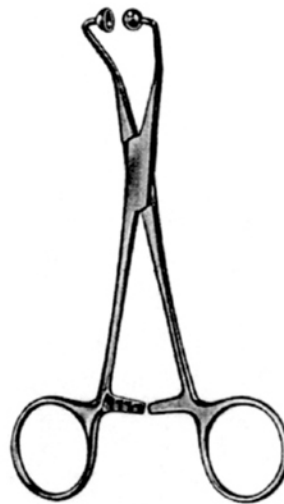

**BALL AND SOCKET**

G14.14.0722.13 13.0cm



**TOHOKU**

G14.14.0726.10 10.0cm  
G14.14.0726.13 13.0cm

14.0726.13

**14-040**

www.g14surgical.com

Towel Clamps EN

Tuchklemmen DE

Pinzas para compresas, pinzas de campo ES

14

# ARTERY FORCEPS



**SCHAEDEL**  
G14.14.0730.09 9.0cm



**ENGLISH MODEL**  
G14.14.0732.09 9.0cm



**JONES**  
G14.14.0734.05 5.0cm  
G14.14.0734.09 9.0cm



**JONES**  
G14.14.0736.09 9.0cm



**BACKHAUS**  
G14.14.0740.08 08.0cm  
G14.14.0740.09 09.0cm  
G14.14.0740.11 11.0cm  
G14.14.0740.13 13.0cm  
G14.14.0740.14 14.0cm  
G14.14.0740.15 15.0cm



**DELICATE**  
G14.14.0742.11 11.0cm  
G14.14.0742.13 13.0cm



G14.14.0746.11 11.0cm



**ROEDER**  
G14.14.0750.13 13.0cm  
G14.14.0750.15 15.0cm

14.0750.15

**14-041**

[www.g14surgical.com](http://www.g14surgical.com)

EN Towel Clamps

DE Tuchklemmen

ES Pinzas para compresas, pinzas de campo



## ARTERY FORCEPS



**ROBIN**  
G14.14.0754.13 13.5cm



**ROBIN**  
G14.14.0756.13 13.5cm



**BERNHARD**  
G14.14.0758.16 16.5cm

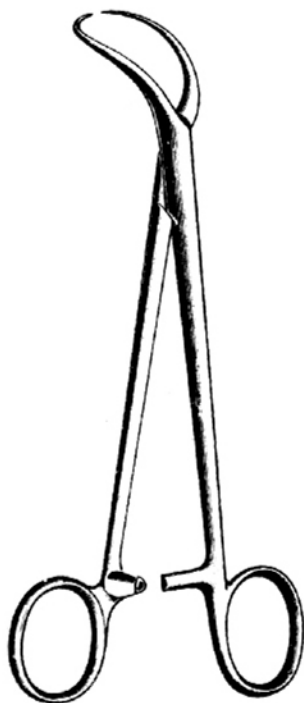

**MAYO**  
G14.14.0760.14 14.0cm

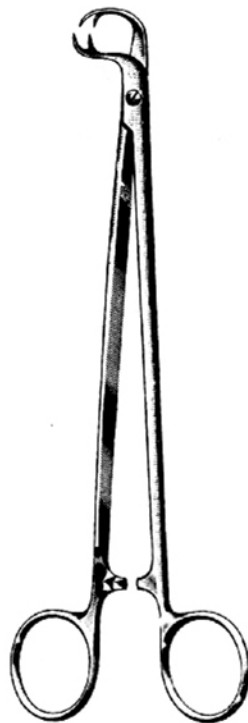

**MOYNIHAN**  
G14.14.0762.19 19.0cm



**MOYNIHAN**  
G14.14.0764.18 18.0cm



**DOYEN**  
G14.14.0766.18 18.0cm

14.0766.18

**14-042**

[www.g14surgical.com](http://www.g14surgical.com)