

# BONE SURGERY

# 26



PAGE 001 to 020



- EN Bone Surgery
- DE Kochenchirurgie
- ES Cirugía ósea

SERVING HEALTHCARE WORLDWIDE

[WWW.g14surgical.com](http://WWW.g14surgical.com)



BONE SURGERY



**CHARRIERE**  
 G14.26.0010.27 27.0cm  
 G14.26.0010.30 30.0cm  
 G14.26.0010.34 34.0cm

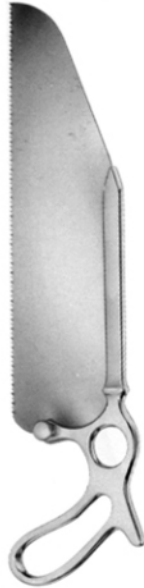

**SATTERLEE**  
 G14.26.0014.31 31.0cm



**CHARRIERE**  
 G14.26.0020.27 27.0cm  
 G14.26.0020.30 30.0cm



**SATTERLEE**  
 G14.26.0024.31 31.0cm

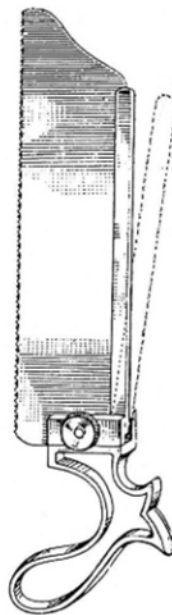

G14.26.0030.23 23.0cm

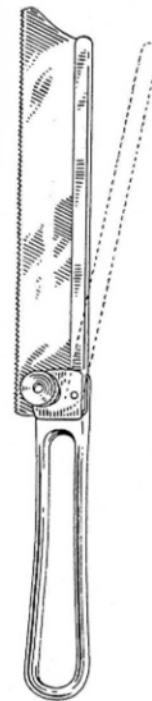

G14.26.0034.19 19.0cm

26.0034.19

**26-001**

[www.g14surgical.com](http://www.g14surgical.com)



## BONE SURGERY



**SPARE SAW BLADE**  
 G14.26.0040.12 12mm  
 G14.26.0040.15 15mm  
 G14.26.0040.18 18mm



**CHAARRIERE**  
 G14.26.0040.35 35.0cm



**SPARE SAW BLADE**  
 G14.26.0044.03 3mm  
 G14.26.0044.05 5mm  
 G14.26.0044.07 7mm



**HELFERICH-BIER**  
 G14.26.0044.39 39.0cm



**LINDEMANN**  
 G14.26.0050.20 20.0cm



**LANGENBECK**  
 G14.26.0054.23 23.0cm

G14.26.0060.06 6mm  
 G14.26.0060.08 8mm  
 G14.26.0060.12 12mm  
 G14.26.0060.15 15mm  
 G14.26.0060.18 18mm

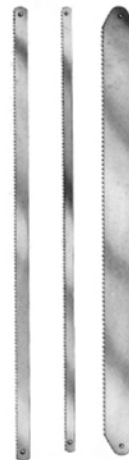

**RUST**  
 G14.26.0060.39 39.0cm



26.0060.39

**26-002**

www.g14surgicals.com

## BONE SURGERY



**STILLE-SHERMAN**

24.0cm

G14.26.0070.00 compl. set

G14.26.0070.24 drill only



G14.26.0072.25  
2.5mm Ø



G14.26.0072.30  
3.0mm Ø



G14.26.0072.35  
3.5mm Ø



**HUDSON**

G14.26.0074.00 compl. set / 6  
(26.0074.27,01,  
02,03,07,09)

G14.26.0074.27 handle only



G14.26.0076.01  
9mm Ø



G14.26.0076.02  
14mm Ø



G14.26.0076.03  
16mm Ø



G14.26.0076.04  
22mm Ø



**CUSHING**  
G14.26.0076.05  
14mm Ø



G14.26.0076.06  
2mm Ø



**MCKENZIE**  
G14.26.0076.07  
13mm Ø



**ERRICO**  
G14.26.0076.08  
16mm Ø



G14.26.0076.09

26.0076.09

**26-003**

[www.g14surgical.com](http://www.g14surgical.com)

EN Hand Drills

DE Handbohrapparate

ES Perforadores de mano



## BONE SURGERY

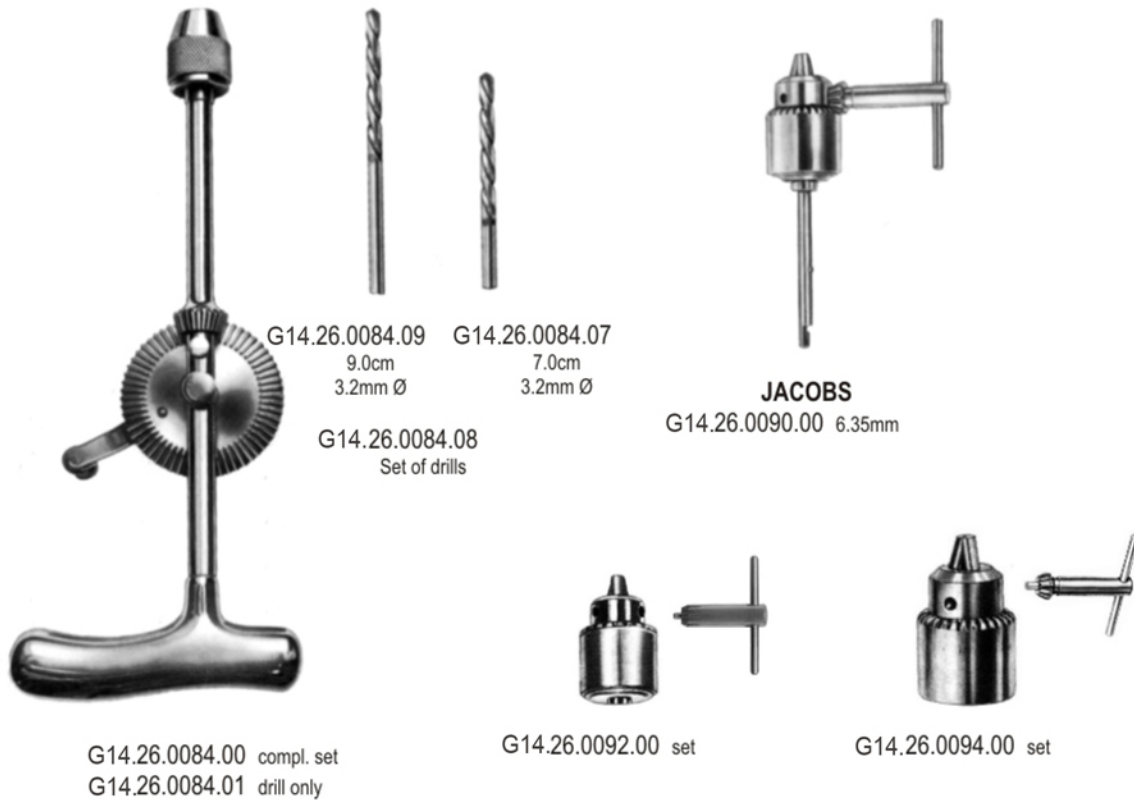
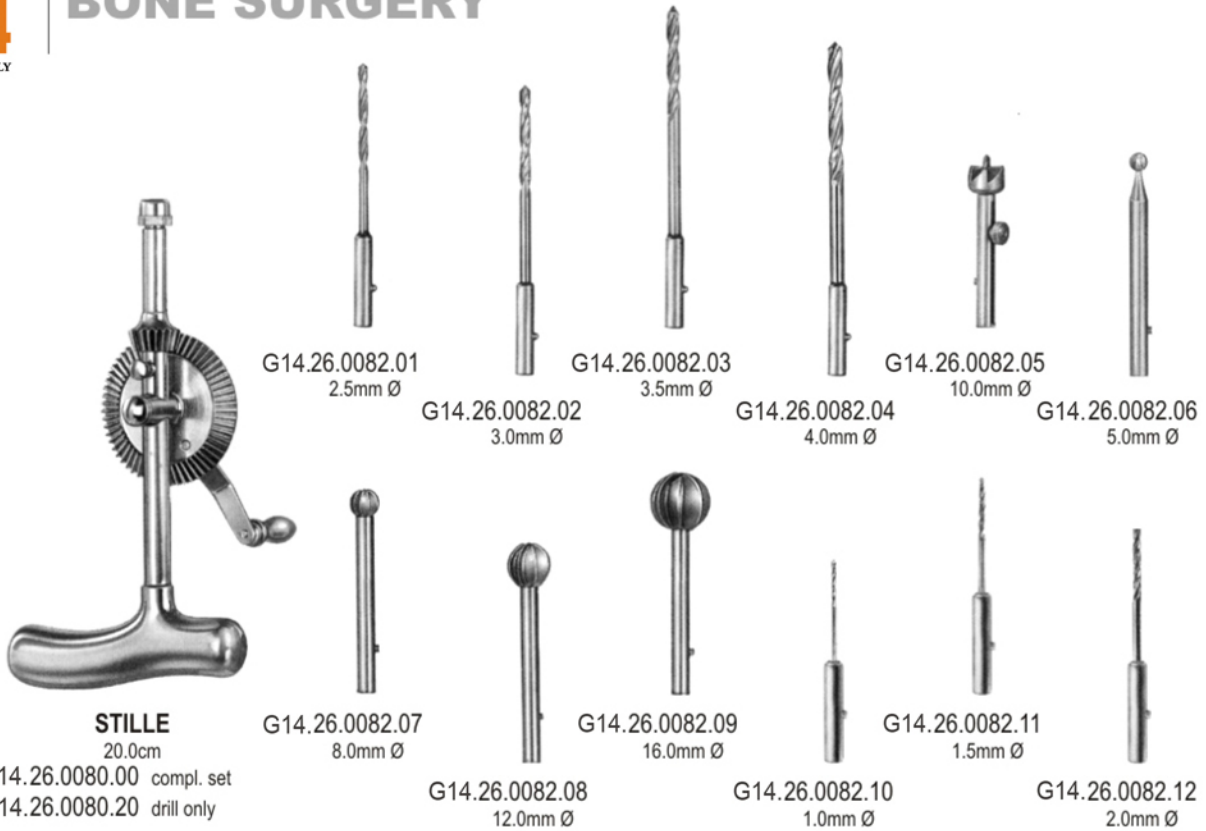

26.0094.00

**26-004**

www.g14surgical.com

BONE SURGERY



**BUNNELL**  
G14.26.0100.00



**RALK**  
G14.26.0104.00



**RALK-UNIVERSAL**  
G14.26.0108.00 Left hand  
G14.26.0110.00 Right hand



G14.26.0112.00

26.0112.00

**26-005**

[www.g14surgical.com](http://www.g14surgical.com)

## BONE SURGERY



G14.26.0116.00



G14.26.0120.00



G14.26.0122.00



G14.26.0124.01



G14.26.0128.01

G14.26.0128.02

G14.26.0128.03

**KIRSCHNER**

G14.26.0128.00 complete set

26.0128.03

**26-006**

[www.g14surgical.com](http://www.g14surgical.com)

G14.26.0124.00 complete set

BONE SURGERY

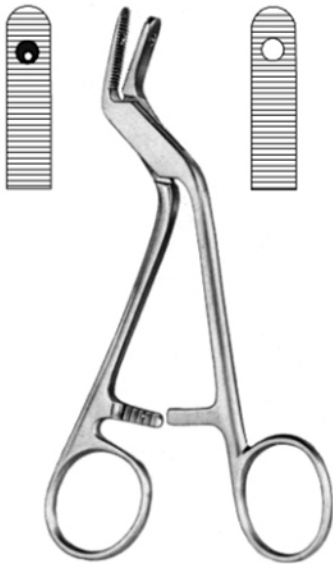

**ADSON**  
 G14.26.0130.15  
 15.0cm



**ADSON**  
 G14.26.0134.18  
 18.0cm

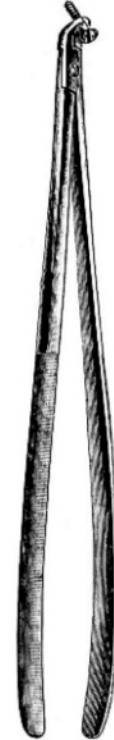

**LANE**  
 G14.26.0140.22  
 22.0cm

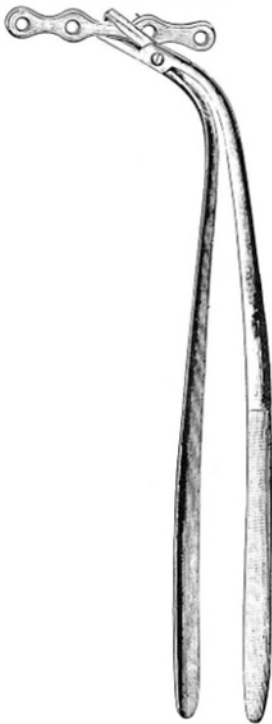

**LANE**  
 G14.26.0144.22  
 22.0cm

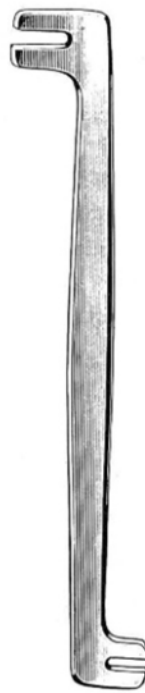

**LANE**  
 G14.26.0150.18  
 18.0cm



G14.26.0154.25  
 25.5cm

26.0154.25

**26-007**

[www.g14surgical.com](http://www.g14surgical.com)

EN Screw Drivers

DE Schraubenzieher

ES Destornilladores



## BONE SURGERY

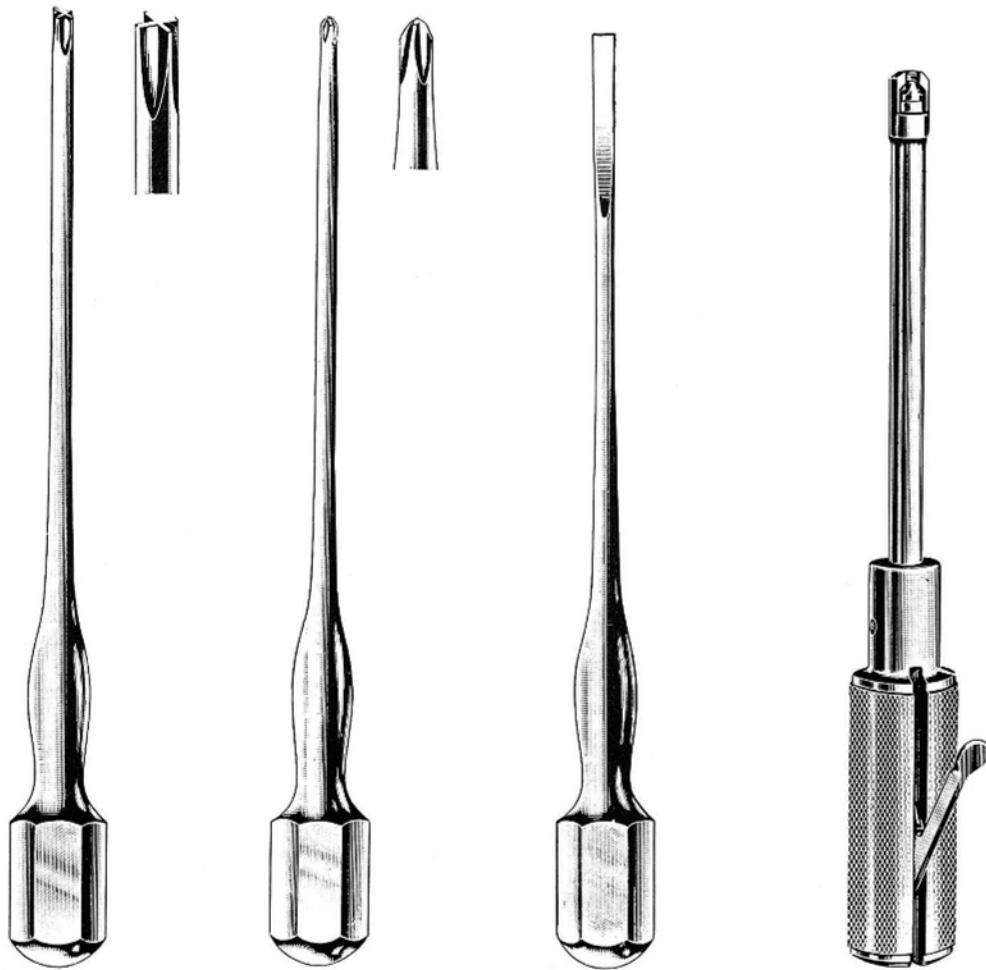

		<b>PHILLIPS</b>		<b>LANE</b>		<b>WILLIAMS</b>	
G14.26.0160.25	25.0cm	G14.26.0164.25	25.0cm	G14.26.0170.17	17.0cm	G14.26.0174.24	24.0cm
				G14.26.0170.25	25.0cm		

26.0174.24

**26-008**

[www.g14surgical.com](http://www.g14surgical.com)

Screw Drivers EN

Schraubenzieher DE

Destornilladores ES

26

BONE SURGERY

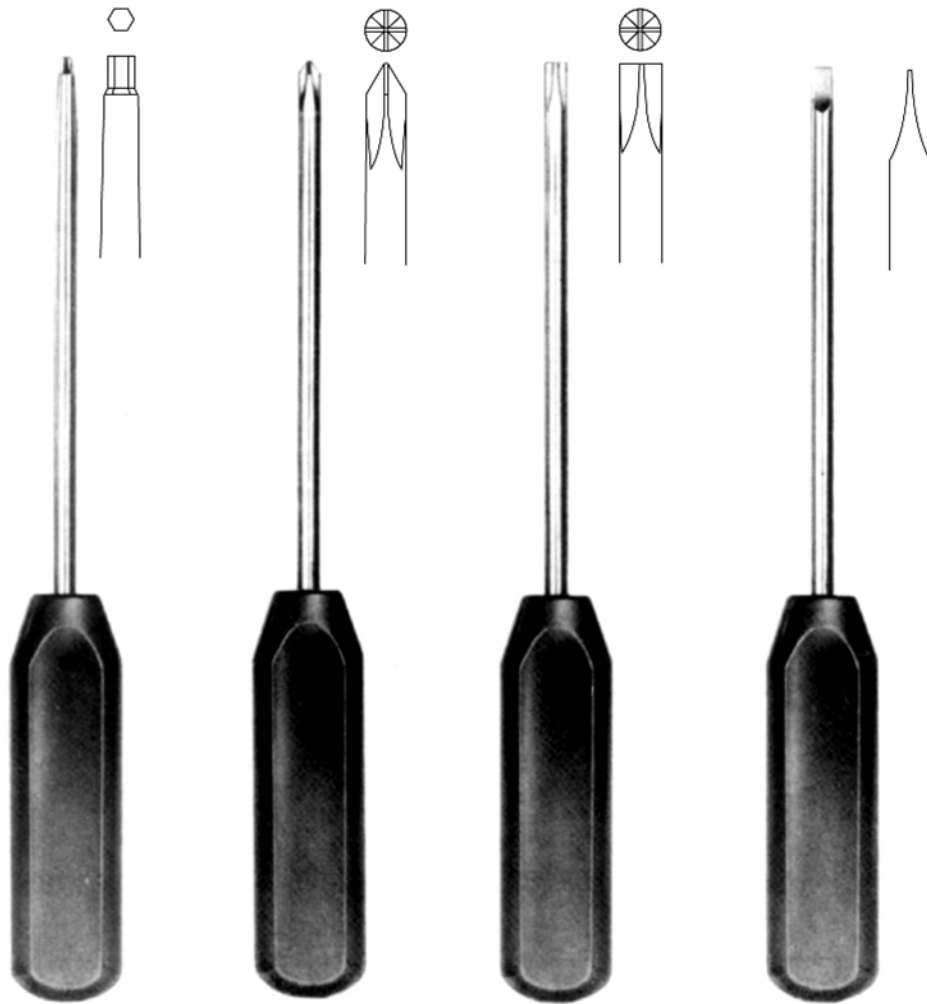

PHILLIPS

G14.26.0180.25 2.5mm  
G14.26.0180.35 3.5mm  
G14.26.0180.45 4.5mm  
25.0cm

G14.26.0184.25 25.0cm

G14.26.0190.25 25.0cm

LANE

G14.26.0194.17 17.0cm  
G14.26.0194.25 25.0cm

26.0194.25

26-009

www.g14surgical.com

EN Screw Driver set in case  
 DE Schraubenzicher-set mit-Etui  
 ES Juego de destornilladores en esuche



## BONE SURGERY



G14.26.0200.14 14.5cm



G14.26.0200.13



G14.26.0200.00 Screw driver set, complete in case  
 G14.26.0200.01 Sterilizing case only



G14.26.0200.02

-



G14.26.0200.03

+



G14.26.0200.04

+



G14.26.0200.05

+

2.5mm

3.5mm



G14.26.0200.06  
 G14.26.0200.07

26.0200.07

**26-010**

www.g14surgical.com

BONE SURGERY



G14.26.0210.24  
2.4mm



G14.26.0210.32  
3.2mm



G14.26.0210.48  
4.8mm



G14.26.0210.64  
6.4mm



G14.26.0220.14 14.0cm



G14.26.0222.14 14.0cm



**PERTHES**  
G14.26.0224.21 21.0mm

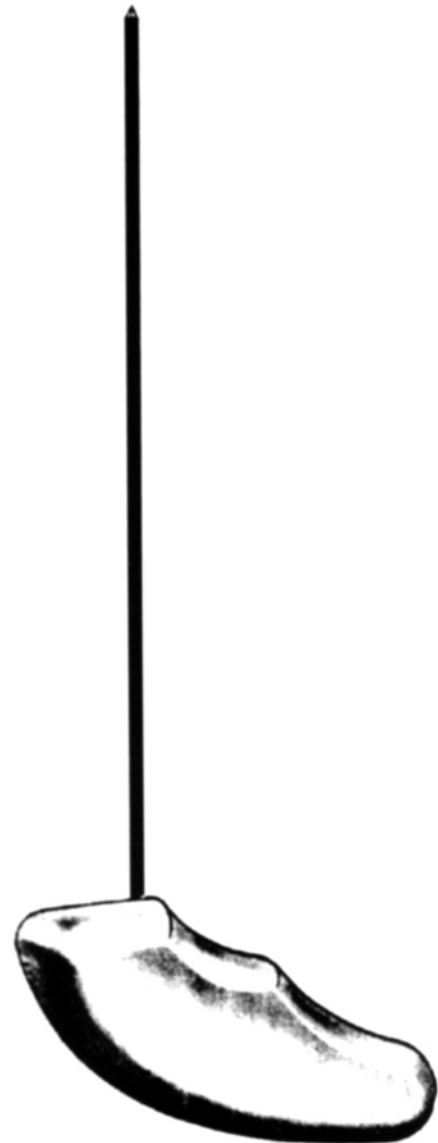

G14.26.0226.24 2.4mm  
 G14.26.0226.32 3.2mm  
 G14.26.0226.48 4.8mm  
 G14.26.0226.64 6.4mm

26.0226.64

**26-011**

[www.g14surgical.com](http://www.g14surgical.com)

EN Flat Nose Pliers, Wire Cutting Pliers, Seizing Forceps

DE Flachzangen, Draht-kheifzangen, Faßzangen

ES Alicates planos, alicates para cortar alambre, pinzas para coger



## BONE SURGERY

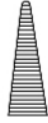

G14.26.0230.16 16.5cm

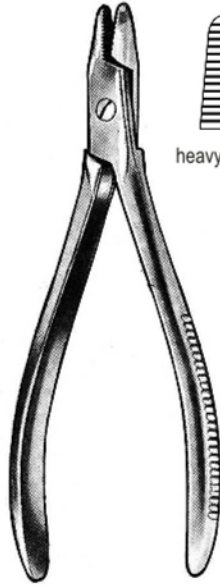

heavy pattern

G14.26.0232.16 16.0cm

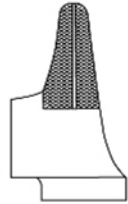

G14.26.0236.15 15.0cm



G14.26.0240.17 17.0cm



G14.26.0242.18 18.0cm



G14.26.0244.18 18.0cm

26.0244.18

**26-012**

[www.g14surgicals.com](http://www.g14surgicals.com)

Flat Nose Pliers EN

Flachzangen DE

Alicates planos ES

# 26

## BONE SURGERY



17.0cm

G14.26.0250.01



G14.26.0250.02



18.0cm

G14.26.0254.01



G14.26.0254.02



G14.26.0254.03

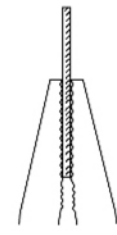

parallel action



14.0cm

G14.26.0258.01



G14.26.0258.02



G14.26.0262.16 16.0cm

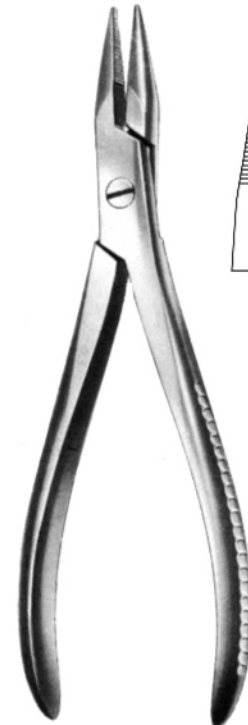
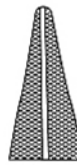

G14.26.0266.19 19.5cm

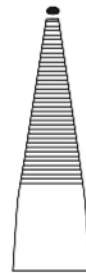

26.0266.19

### 26-013

[www.g14surgical.com](http://www.g14surgical.com)

EN Impactor/Extractor, Wire Tighteners and Accessories

DE Vorschlaginstrument-Nagelzieher, drahtspanninstrumente und Zubehor

ES Conductor-extractor, tensores cierra-hilo y accesorios



## BONE SURGERY



**PARHAM**

G14.26.0270.18 18.0cm

G14.26.0270.20 20.0cm

G14.26.0270.25 25.0cm

G14.26.0270.30 30.0cm



**PARHAM**

G14.26.0274.22 22.0cm

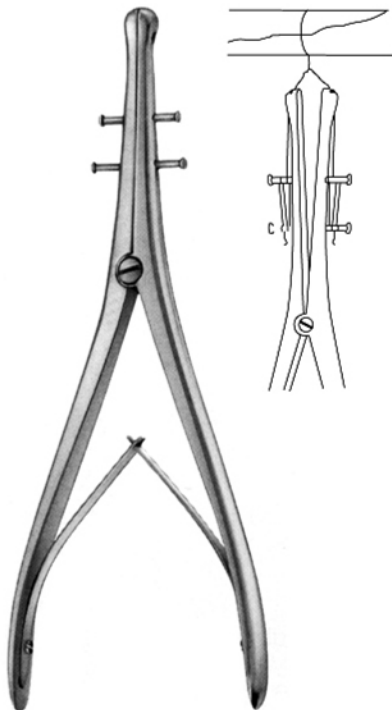

**DEMEL**

G14.26.0280.28 28.0cm



**LOUTE**

G14.26.0284.21 21.0cm

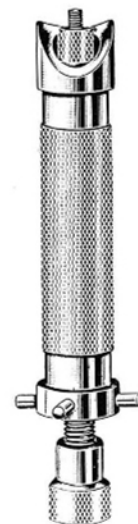

**LLOYD**

G14.26.0288.00

26.0288.00

**26-014**

www.g14surgical.com

BONE SURGERY



	soft	hard
0.2mm Ø	G14.26.0290.02	
0.3mm Ø	G14.26.0290.03	G14.26.0292.03
0.4mm Ø	G14.26.0290.04	G14.26.0292.04
0.5mm Ø	G14.26.0290.05	
0.6mm Ø	G14.26.0290.06	G14.26.0292.06
0.7mm Ø	G14.26.0290.07	
0.8mm Ø	G14.26.0290.08	G14.26.0292.08
0.9mm Ø	G14.26.0290.09	
1.0mm Ø	G14.26.0290.10	G14.26.0292.10
1.2mm Ø	G14.26.0290.12	
1.5mm Ø	G14.26.0290.15	

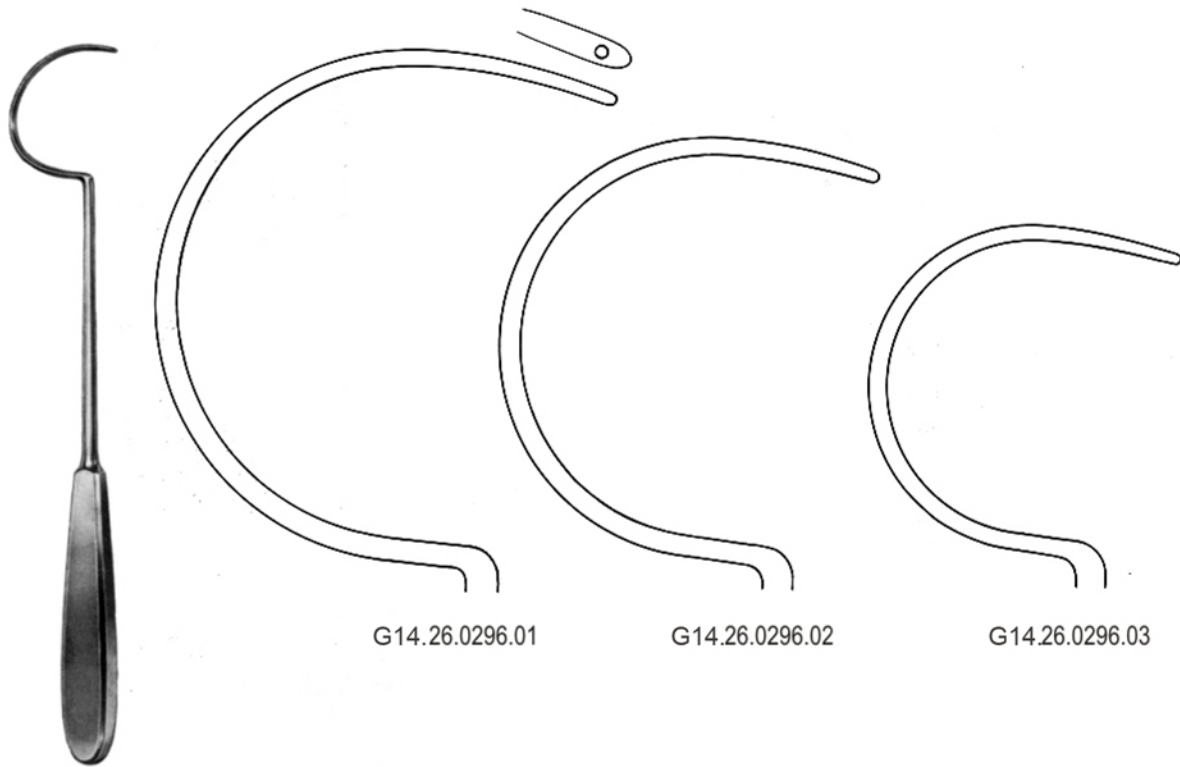

G14.26.0296.01

G14.26.0296.02

G14.26.0296.03

DEMEL

26.0296.03

26-015

www.g14surgical.com



**KUENTSCHER**  
 G14.26.0304.21 21.0cm

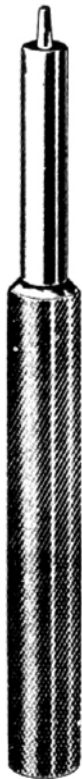

**KUENTSCHER**  
 G14.26.0306.21 21.0cm



**KUENTSCHER**  
 G14.26.0310.00 63.0cm  
 complete set



G14.26.0310.01

G14.26.0310.02

G14.26.0310.03

G14.26.0310.04

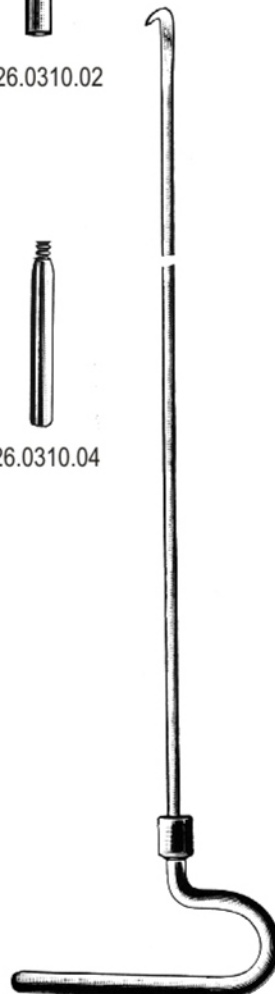

G14.26.0314.29 29.0cm  
 G14.26.0314.37 37.0cm  
 G14.26.0314.42 42.0cm  
 G14.26.0314.49 49.0cm

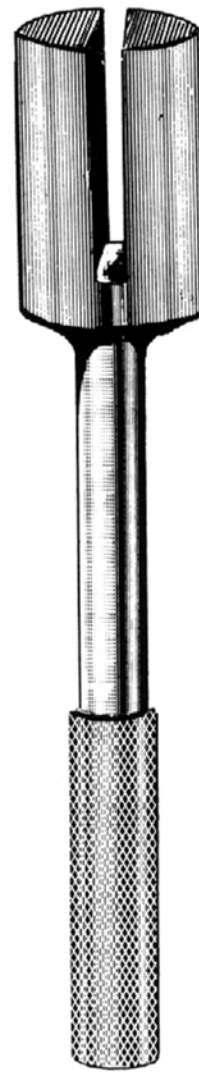

G14.26.0320.00

BONE SURGERY



L=35cm

L=46cm

L=60cm

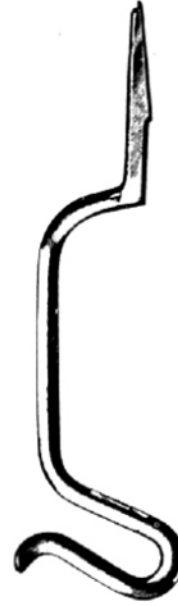

**KUENTSCHER**

**KUENTSCHER**

- 2.5mm Ø G14.26.0330.25
- 3.0mm Ø G14.26.0330.30
- 3.5mm Ø G14.26.0330.35
- 4.0mm Ø G14.26.0330.40
- 5.0mm Ø G14.26.0330.50

- G14.26.0332.25
- G14.26.0332.30
- G14.26.0332.35
- G14.26.0332.40
- G14.26.0332.50

- G14.26.0334.35
- G14.26.0334.40
- G14.26.0334.50

G14.26.0340.26 26.0cm

G14.26.0344.35 35.0cm



**STEINMANN**

4mm Ø (Trocar tip)

- G14.26.0360.14 140mm
- G14.26.0360.16 160mm
- G14.26.0360.18 180mm
- G14.26.0360.20 200mm



**SCHANZ**

4mm Ø (Flat tip)

- G14.26.0364.06 60mm
- G14.26.0364.08 80mm
- G14.26.0364.10 100mm



**SCHANZ**

6mm Ø (Flat tip)

- G14.26.0366.10 100mm
- G14.26.0366.13 130mm
- G14.26.0366.16 160mm
- G14.26.0366.19 190mm



**SCHANZ**

5mm Ø (Trocar tip)

- G14.26.0368.10 100mm
- G14.26.0368.12 125mm
- G14.26.0368.15 150mm
- G14.26.0368.17 170mm
- G14.26.0368.20 200mm
- G14.26.0368.25 250mm

26.0368.25

**26-017**

www.g14surgical.com

# 26

EN Steinmann Pins

DE Steinmann Nagel

ES Calvos segun steinmann



## BONE SURGERY

### KIRSCHNER

trocar point  
flat end



mm ø	60 mm	120mm	140mm	160mm	310mm
0.6	G14.26.0380.06				
0.8	G14.26.0380.08				
1.0	G14.26.0380.10	G14.26.0382.10	G14.26.0384.10	G14.26.0386.10	G14.26.0388.10
1.2	G14.26.0380.12	G14.26.0382.12	G14.26.0384.12	G14.26.0386.12	G14.26.0388.12
1.4	G14.26.0380.14	G14.26.0382.14	G14.26.0384.14	G14.26.0386.14	G14.26.0388.14
1.5	G14.26.0380.15	G14.26.0382.15	G14.26.0384.15	G14.26.0386.15	G14.26.0388.15
1.6	G14.26.0380.16	G14.26.0382.16	G14.26.0384.16	G14.26.0386.16	G14.26.0388.16
1.8	G14.26.0380.18	G14.26.0382.18	G14.26.0384.18	G14.26.0386.18	G14.26.0388.18
2.0	G14.26.0380.20	G14.26.0382.20	G14.26.0384.20	G14.26.0386.20	G14.26.0388.20
2.2	G14.26.0380.22	G14.26.0382.22	G14.26.0384.22	G14.26.0386.22	G14.26.0388.22
2.5	G14.26.0380.25	G14.26.0382.25	G14.26.0384.25	G14.26.0386.25	G14.26.0388.25

### KIRSCHNER

trocar point  
round end



mm ø	60 mm	120mm	140mm	160mm	310mm
1.0	G14.26.0390.10	G14.26.0392.10	G14.26.0394.10	G14.26.0396.10	G14.26.0398.10
1.2	G14.26.0390.12	G14.26.0392.12	G14.26.0394.12	G14.26.0396.12	G14.26.0398.12
1.4	G14.26.0390.14	G14.26.0392.14	G14.26.0394.14	G14.26.0396.14	G14.26.0398.14
1.5	G14.26.0390.15	G14.26.0392.15	G14.26.0394.15	G14.26.0396.15	G14.26.0398.15
1.6	G14.26.0390.16	G14.26.0392.16	G14.26.0394.16	G14.26.0396.16	G14.26.0398.16
1.8	G14.26.0390.18	G14.26.0392.18	G14.26.0394.18	G14.26.0396.18	G14.26.0398.18
2.0	G14.26.0390.20	G14.26.0392.20	G14.26.0394.20	G14.26.0396.20	G14.26.0398.20
2.2	G14.26.0390.22	G14.26.0392.22	G14.26.0394.22	G14.26.0396.22	G14.26.0398.22
2.5	G14.26.0390.25	G14.26.0392.25	G14.26.0394.25	G14.26.0396.25	G14.26.0398.25

### KIRSCHNER

lancet point  
flat end



mm ø	100 mm
1.0	G14.26.0400.10
1.2	G14.26.0400.12
1.5	G14.26.0400.15
1.6	G14.26.0400.16
1.8	G14.26.0400.18
2.0	G14.26.0400.20
2.2	G14.26.0400.22
2.5	G14.26.0400.25

26.0400.25

**26-018**

[www.g14surgical.com](http://www.g14surgical.com)

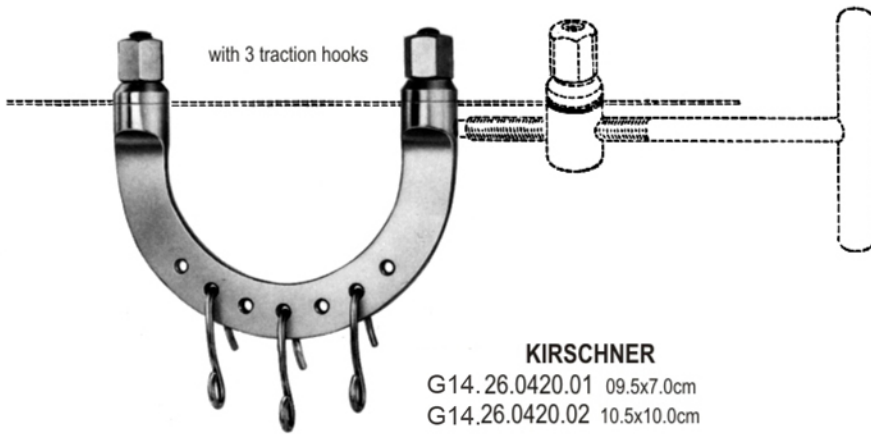

with 3 traction hooks

**KIRSCHNER**

- G14.26.0420.01 09.5x7.0cm
- G14.26.0420.02 10.5x10.0cm
- G14.26.0420.03 12.0x12.0cm
- G14.26.0420.04 15.5x15.5cm
- G14.26.0420.05 20.0x15.5cm



with 3 traction hooks

**KIRSCHNER**

- G14.26.0424.01 6.0x6.0cm

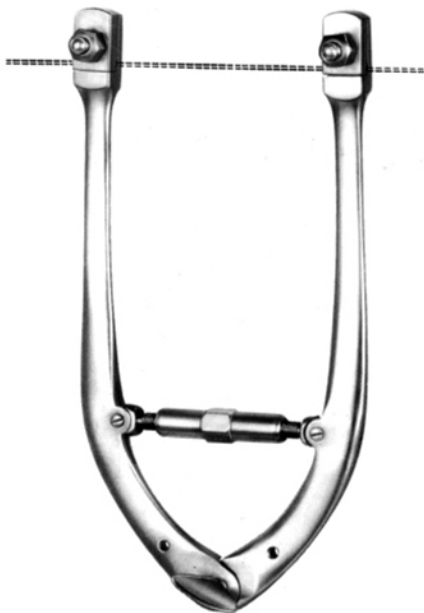

- G14.26.0430.18 18.0x10.0cm
- G14.26.0430.27 27.0x27.0cm



- G14.26.0434.18



- G14.26.0440.19 19.0cm



- G14.26.0444.03

- G14.26.0444.06

26.0444.06

**26-019**

[www.g14surgical.com](http://www.g14surgical.com)

## BONE SURGERY

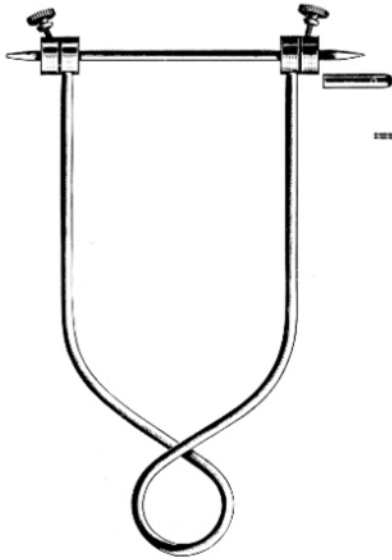

**BÖHLER**

G14.26.0450.15 21.0x15.0cm  
 G14.26.0450.16 16.0x 9.0cm  
 G14.26.0450.21 21.0x11.0cm



**KIRSCHNER**

G14.26.0454.01 13.5cm, infant  
 G14.26.0454.02 18.5cm, child  
 G14.26.0454.03 27.0cm, adult



**MARTIN-DIAMANT**

G14.26.0460.16  
 16.0cm



G14.26.0464.16  
 16.0cm



G14.26.0470.15  
 15.0cm



G14.26.0474.23  
 23.0cm



G14.26.0474.25  
 25.0cm



G14.26.0480.24  
 24.0cm

26.0480.24

**26-020**

www.g14surgical.com