

GYNECOLOGY

60



PAGE 001 to 042



- EN Gynecology
- DE Gynäkologie
- ES Ginecología

SERVING HEALTHCARE WORLDWIDE

WWW.g14surgical.com



Vaginal Specula EN

Scheidenspekula DE

Especulos vaginales ES

60

GYNECOLOGY

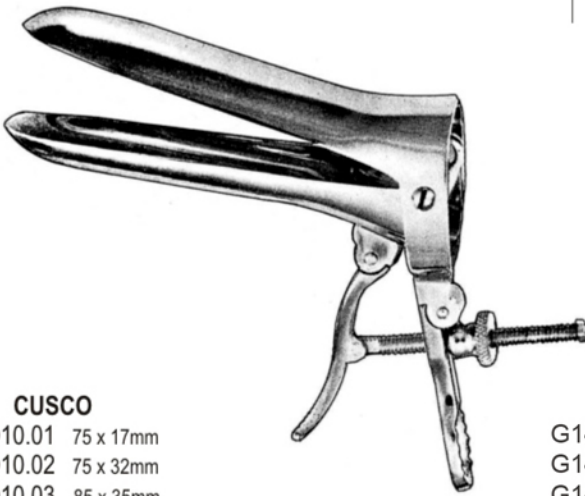

CUSCO

- G14.60.0010.01 75 x 17mm
- G14.60.0010.02 75 x 32mm
- G14.60.0010.03 85 x 35mm
- G14.60.0010.04 100 x 37mm

CUSCO

- G14.60.0014.01 75 x 17mm
- G14.60.0014.02 75 x 32mm
- G14.60.0014.03 80 x 32mm
- G14.60.0014.04 85 x 35mm
- G14.60.0014.05 110 x 35mm
- G14.60.0014.06 115 x 37mm



CUSCO

- G14.60.0020.01 75 x 32mm
- G14.60.0020.02 85 x 35mm
- G14.60.0020.03 100 x 35mm
- G14.60.0020.04 85 x 35mm (with cold light carrier)
- G14.60.0020.05 (cold light carrier only)

CUSCO

- G14.60.0022.01 75 x 17mm
- G14.60.0022.02 85 x 17mm
- G14.60.0022.03 100 x 17mm



CUSCO (Swiss pattern)

- G14.60.0024.01 80 x 22mm
- G14.60.0024.02 100 x 25mm
- G14.60.0024.03 105 x 27mm
- G14.60.0024.04 115 x 27mm

CUSCO'S

- G14.60.0026.01 (LL)
- G14.60.0026.02 (L)
- G14.60.0026.03 (M)
- G14.60.0026.04 (S)
- G14.60.0026.05 (SS)
- G14.60.0026.06 (SSS)

60.0026.06

60-001

www.g14surgical.com

60

EN Vaginal Specula

DE Scheidenspekula

ES Especulos vaginales



GYNECOLOGY



PEDERSON

- G14.60.0030.01 75 x 13mm
- G14.60.0030.02 100 x 22mm
- G14.60.0030.03 120 x 25mm
- G14.60.0030.04 130 x 25mm



GRAVE

- G14.60.0034.01 75 x 20mm
- G14.60.0034.02 95 x 35mm
- G14.60.0034.03 115 x 35mm
- G14.60.0034.04 125 x 35mm



SEMM

- G14.60.0040.01 100 x 17/20mm
- G14.60.0040.02 100 x 25/30mm



FERGUSSON

- G14.60.0050.01 25mm Ø
- G14.60.0050.02 30mm Ø
- G14.60.0050.03 35mm Ø
- G14.60.0050.04 40mm Ø

60.0050.04

60-002

www.g14surgicals.com

Vaginal Specula EN

Scheidenspekula DE

Especulos vaginales ES

60

GYNECOLOGY

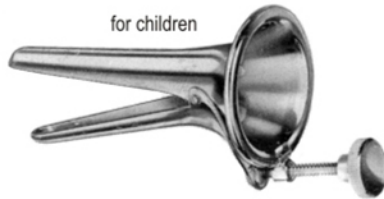

for children

COLLIN

G14.60.0054.01 55 x 10mm



COLLIN

G14.60.0060.01 65 x 20mm



COLLIN-LANDAU

G14.60.0064.01 100 x 35mm



COLLIN

G14.60.0066.01 85 x 30mm
G14.60.0066.02 100 x 35mm
G14.60.0066.03 110 x 40mm
G14.60.0066.04 100 x 35mm (with cold light carrier)
G14.60.0066.05 (cold light carrier only)



TRELAT

G14.60.0068.01 85 x 33mm
G14.60.0068.02 95 x 35mm
G14.60.0068.03 115 x 43mm



SAKURAI'S

G14.60.0070.01 (LL)
G14.60.0070.02 (L)
G14.60.0070.03 (M)
G14.60.0070.04 (S)

60.0070.04

60-003

www.g14surgical.com

EN Vaginal Specula

DE Scheidenspekula

ES Especulos vaginales



GYNECOLOGY

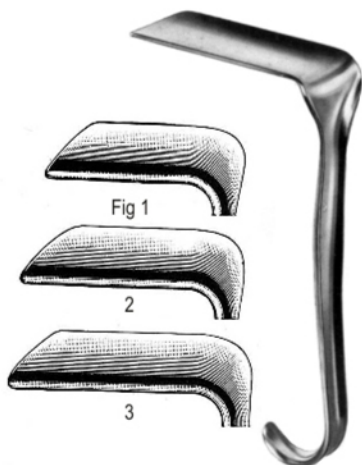

JACKSON

- G14.60.0080.01 75 x 35mm
- G14.60.0080.02 90 x 35mm
- G14.60.0080.03 100 x 35mm
- G14.60.0080.04 75 x 40mm
- G14.60.0080.05 90 x 40mm
- G14.60.0080.06 100 x 40mm

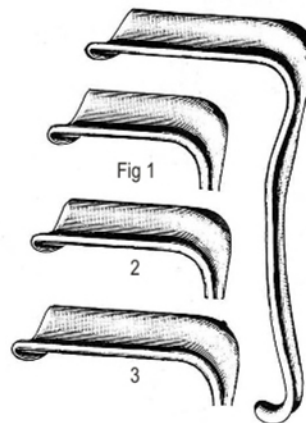

EASTMANN

- G14.60.0084.01 75 x 35mm
- G14.60.0084.02 90 x 35mm
- G14.60.0084.03 100 x 35mm
- G14.60.0084.04 75 x 40mm
- G14.60.0084.05 90 x 40mm
- G14.60.0084.06 100 x 40mm



SIMS

- G14.60.0090.01 65 x 25, 70 x 30mm
- G14.60.0090.02 70 x 30, 70 x 35mm
- G14.60.0090.03 85 x 35, 90 x 40mm
- G14.60.0090.04 100 x 35 x 40mm
- G14.60.0090.05 120 x 35 x 40mm



SIMS

- G14.60.0094.01 60 x 25mm
- G14.60.0094.02 70 x 30mm
- G14.60.0094.03 80 x 35mm

60.0094.03

60-004

www.g14surgical.com

Vaginal specula and Retractors EN

Scheidenspekula und halter DE

Especulas y valvas vaginales ES

60

GYNECOLOGY



56 x 13mm

BRAUN

G14.60.0100.18 18.0cm



60 x 10mm

BRAUN

G14.60.0102.18 18.0cm

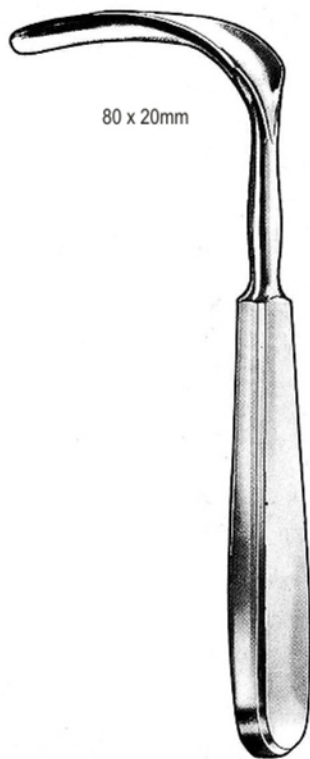

80 x 20mm

ULRICH

G14.60.0110.19 19.5cm

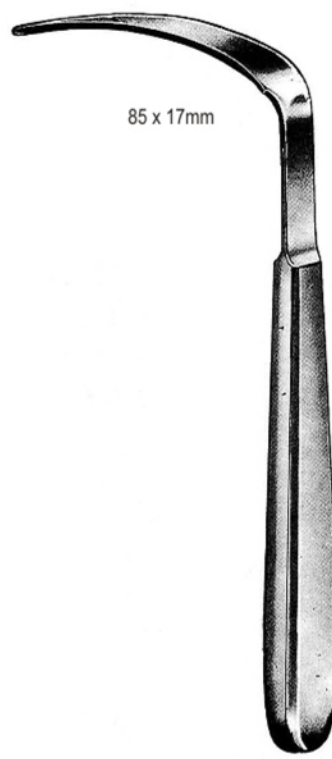

85 x 17mm

G14.60.0112.19 19.0cm

60.0112.19

60-005

www.g14surgical.com

60

EN Vaginal Specula and Retractors

DE Scheidenspekula und halter

ES Especulos y valvas vaginales



GYNECOLOGY



KRISTELLER
specula

Fig 1. G14.60.0120.01 110 x 18mm
Fig 2. G14.60.0120.02 110 x 21mm



KRISTELLER
retractors

Fig 1. G14.60.0122.01 115 x 14mm
Fig 2. G14.60.0122.02 115 x 17mm



KRISTELLER
set of 1 speculum and 1 retractor each
Fig 1. G14.60.0124.00
Fig 2. G14.60.0126.00



KRISTELLER
specula

Fig.1 G14.60.0130.01 70 x 27mm
Fig.2 G14.60.0130.02 80 x 30mm
Fig.3 G14.60.0130.03 90 x 36mm



KRISTELLER
retractors

Fig.1 G14.60.0132.01 75 x 23mm
Fig.2 G14.60.0132.02 85 x 26mm
Fig.3 G14.60.0132.03 100 x 32mm



KRISTELLER
set of 1 speculum and 1 retractors each
Fig.1 G14.60.0134.00
Fig.2 G14.60.0136.00
Fig.3 G14.60.0138.00

60.0138.00

60-006

www.g14surgicals.com

GYNECOLOGY



KRISTELLER
specula

- G14.60.0140.01 110 x 27mm
- G14.60.0140.02 110 x 30mm
- G14.60.0140.03 110 x 36mm



KRISTELLER
retractors

- G14.60.0142.01 115 x 23mm
- G14.60.0142.02 115 x 26mm
- G14.60.0142.03 115 x 32mm



KRISTELLER
set of 1 speculum and 1 retractor each

- G14.60.0144.00
- G14.60.0146.00
- G14.60.0148.00



KRISTELLER
specula

- Fig.1 G14.60.0150.01 105 x 26mm
- Fig.2 G14.60.0150.02 105 x 28mm
- Fig.3 G14.60.0150.03 105 x 33mm



KRISTELLER
retractors

- Fig.1 G14.60.0152.01 115 x 22mm
- Fig.2 G14.60.0152.02 115 x 24mm
- Fig.3 G14.60.0152.03 115 x 29mm



KRISTELLER
set of 1 speculum and 1 retractors each

- Fig.1 G14.60.0154.00
- Fig.2 G14.60.0156.00
- Fig.3 G14.60.0158.00

60.0158.00

60-007

www.g14surgical.com

60

EN Vaginal Specula and Retractors

DE Scheidenspekula und halter

ES Especulos y valvas vaginales



GYNECOLOGY

extra large pattern



G14.60.0160.01
140 x 30mm



G14.60.0162.01
135 x 36mm



G14.60.0164.01
135 x 36mm

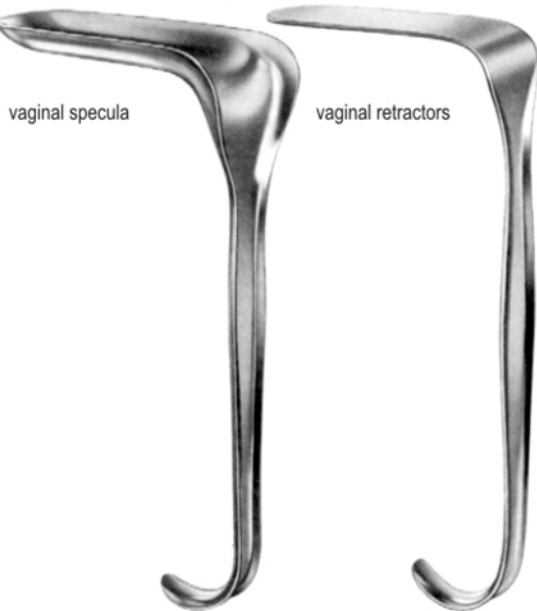

vaginal specula

vaginal retractors

KALLMORGEN

G14.60.0170.01 70 x 40mm

G14.60.0170.02 90 x 40mm

set

G14.60.0174.00

G14.60.0176.00

G14.60.0172.01 70 x 33mm

G14.60.0172.02 90 x 33mm



vaginal specula

vaginal retractors

MATHIEU

G14.60.0180.01 95 x 16mm

95 x 26mm

G14.60.0180.02 95 x 26mm

95 x 30mm

set

G14.60.0184.00

G14.60.0186.00

G14.60.0182.01 100 x 11mm
100 x 20mm

G14.60.0182.02 100 x 14mm
100 x 26mm

60.0186.00

60-008

www.g14surgicals.com

GYNECOLOGY

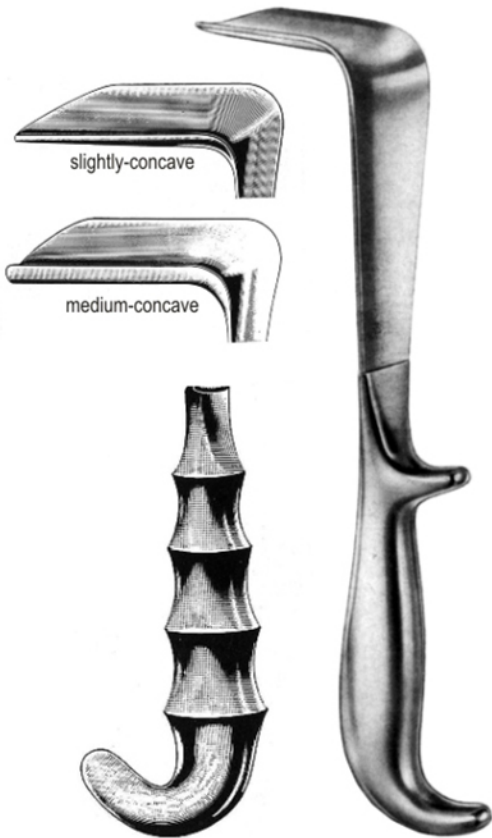
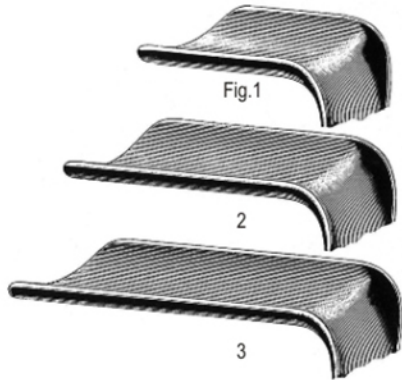

DOYEN FG DOYEN

Fig	mm	mm	slightly-concave	slightly-concave	medium-concave
1	55	35	G14.60.0190.01	G14.60.0200.01	G14.60.0210.01
2	85	35	G14.60.0190.02	G14.60.0200.02	G14.60.0210.02
3	115	35	G14.60.0190.03	G14.60.0200.03	G14.60.0210.03
1	55	45	G14.60.0192.01	G14.60.0202.01	G14.60.0212.01
2	85	45	G14.60.0192.02	G14.60.0202.02	G14.60.0212.02
3	115	45	G14.60.0192.03	G14.60.0202.03	G14.60.0212.03
1	55	60	G14.60.0194.01	G14.60.0204.01	G14.60.0214.01
2	85	60	G14.60.0194.02	G14.60.0204.02	G14.60.0214.02
3	115	60	G14.60.0194.03	G14.60.0204.03	G14.60.0214.03

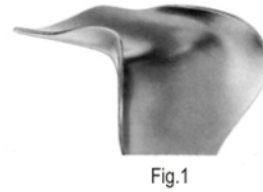

Fig.1



Fig.2



Fig.3



DOYEN

- G14.60.0220.01 75 x 45mm
- G14.60.0220.02 90 x 45mm
- G14.60.0220.03 110 x 45mm

60.0220.03

60-009

www.g14surgical.com

60

EN Vaginal Specula

DE Scheidenspekula

ES Especulos vaginales



GYNECOLOGY



G14.60.0230.40
weight, light, 400gm
G14.60.0230.80
weight, heavy, 800gm

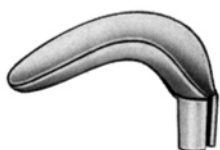

G14.60.0230.01

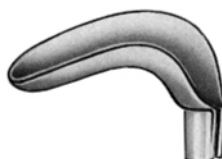

G14.60.0230.02



G14.60.0230.03



G14.60.0230.04



G14.60.0230.05

SCHERBAK

G14.60.0230.00 set complete

G14.60.0230.10 handle only



A
G14.60.0242.10
handle only



70 x 30mm
G14.60.0244.01



80 x 35mm
G14.60.0244.02



90 x 35mm
G14.60.0244.03



100 x 35mm
G14.60.0244.04



80 x 30mm
G14.60.0244.05



85 x 33mm
G14.60.0244.06



100 x 35mm
G14.60.0244.07



110 x 42mm
G14.60.0244.08

BOZEMANN

G14.60.0240.00 compl. set with handle A, B and 8 blades

G14.60.0242.00 compl. set with handle A and 8 blades

G14.60.0244.00 compl. set with handle B and 8 blades



B
G14.60.0244.10
handle only

60.0244.10

60-010

www.g14surgical.com

Vaginal Specula EN

Scheidenspekula DE

Especulos vaginales ES

60

GYNECOLOGY



AUVARD

G14.60.0250.01 80 x 38mm 2 lbs
G14.60.0250.02 80 x 38mm 2.5 lbs
G14.60.0250.03 80 x 38mm 3 lbs



AUVARD

G14.60.0254.00 68 x 40mm 3 lbs



AUVARD

G14.60.0260.01 2.5 lbs
G14.60.0260.02 3 lbs



STEINER-AUVARD

G14.60.0264.01 140 x 35mm 2.5 lbs
G14.60.0266.01 140 x 35mm 2.5 lbs
laser pattern

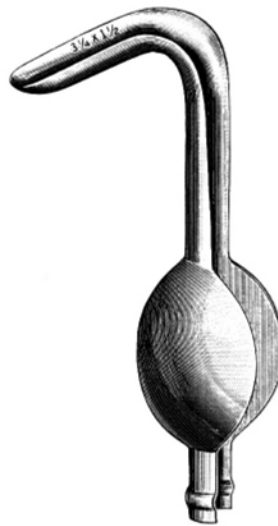

HENROTIN

G14.60.0270.01 80 x 35mm 3 lbs
30° blade angled down

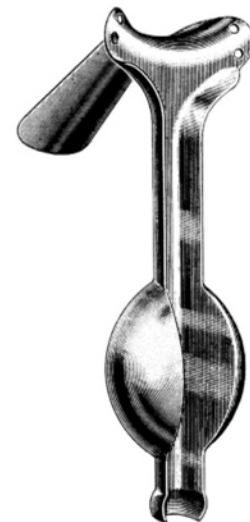

BERLIND-AUVARD

G14.60.0274.01 105 x 40mm 2.5 lbs

60.0274.01

60-011

www.g14surgical.com

60

EN Vaginal Specula and Retractors

DE Scheidenspekula und halter

ES Especulos y valvas vaginales



GYNECOLOGY



LANDAU

G14.60.0300.01 105 x 28mm
G14.60.0300.02 105 x 38mm



BREISKY

G14.60.0304.01 100 x 20mm
G14.60.0304.02 100 x 25mm
G14.60.0304.03 100 x 30mm
G14.60.0304.04 100 x 35mm
G14.60.0304.05 100 x 40mm

G14.60.0306.01 130 x 20mm
G14.60.0306.02 130 x 25mm
G14.60.0306.03 130 x 30mm
G14.60.0306.04 130 x 35mm
G14.60.0306.05 130 x 40mm

G14.60.0308.01 155 x 40mm



DUNKEL

G14.60.0310.22

60.0310.22

60-012

www.g14surgical.com



O'SULLIVAN-O'CONNOR
G14.60.0314.00 set complete



G14.60.0314.01 Fig. 1 = 45 x 17mm
G14.60.0314.02 Fig. 2 = 90 x 37mm
G14.60.0314.03 Fig. 3 = 90 x 45mm

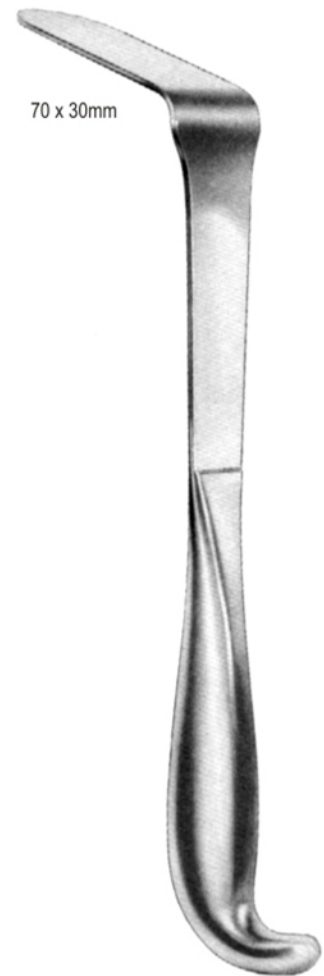

70 x 30mm

DOYEN
G14.60.0320.24 24.0cm

60.0320.24

60-013

www.g14surgical.com

GYNECOLOGY



FRIEDMAN
 G14.60.0324.10 10.0cm

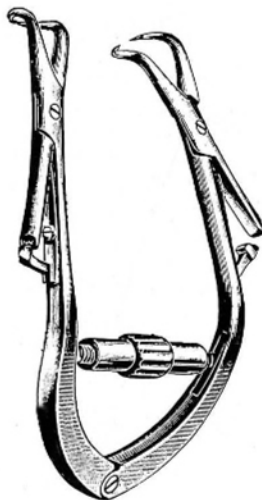

JOLL
 G14.60.0330.15 15.0cm



COMYNS-BERKELEY
 G14.60.0334.00

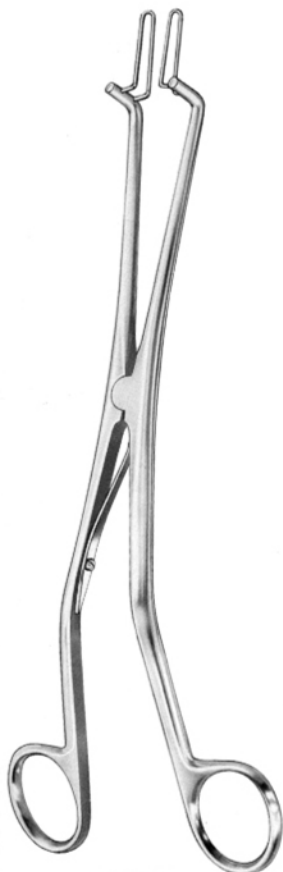

KOGAN
 24.0cm
 G14.60.0340.24 2/4mm
 G14.60.0340.48 4/8mm



KOGAN
 24.0cm laser
 G14.60.0344.24 2/4mm G14.60.0346.24
 G14.60.0344.48 4/8mm G14.60.0346.48

60.0346.48

60-014

GYNECOLOGY



HEGAR

G14.60.0350.01 - G14.60.0350.30
(1.0mm - 30.0mm)

	mm dia.		mm dia.
G14.60.0350.01	1.0	G14.60.0351.01	1.5
G14.60.0350.02	2.0	G14.60.0351.02	2.5
G14.60.0350.03	3.0	G14.60.0351.03	3.5
G14.60.0350.04	4.0	G14.60.0351.04	4.5
G14.60.0350.05	5.0	G14.60.0351.05	5.5
G14.60.0350.06	6.0	G14.60.0351.06	6.5
G14.60.0350.07	7.0	G14.60.0351.07	7.5
G14.60.0350.08	8.0	G14.60.0351.08	8.5
G14.60.0350.09	9.0	G14.60.0351.09	9.5
G14.60.0350.10	10.0	G14.60.0351.10	10.5
G14.60.0350.11	11.0	G14.60.0351.11	11.5
G14.60.0350.12	12.0	G14.60.0351.12	12.5
G14.60.0350.13	13.0	G14.60.0351.13	13.5
G14.60.0350.14	14.0	G14.60.0351.14	14.5
G14.60.0350.15	15.0	G14.60.0351.15	15.5
G14.60.0350.16	16.0	G14.60.0351.16	16.5
G14.60.0350.17	17.0	G14.60.0351.17	17.5
G14.60.0350.18	18.0	G14.60.0351.18	18.5
G14.60.0350.19	19.0	G14.60.0351.19	19.5
G14.60.0350.20	20.0	G14.60.0351.20	20.5
G14.60.0350.21	21.0	G14.60.0351.21	21.5
G14.60.0350.22	22.0	G14.60.0351.22	22.5
G14.60.0350.23	23.0	G14.60.0351.23	23.5
G14.60.0350.24	24.0	G14.60.0351.24	24.5
G14.60.0350.25	25.0	G14.60.0351.25	25.5
G14.60.0350.26	26.0	G14.60.0351.26	26.5
G14.60.0350.27	27.0	G14.60.0351.27	27.5
G14.60.0350.28	28.0	G14.60.0351.28	28.5
G14.60.0350.29	29.0	G14.60.0351.29	29.5
G14.60.0350.30	30.0	G14.60.0351.30	30.5

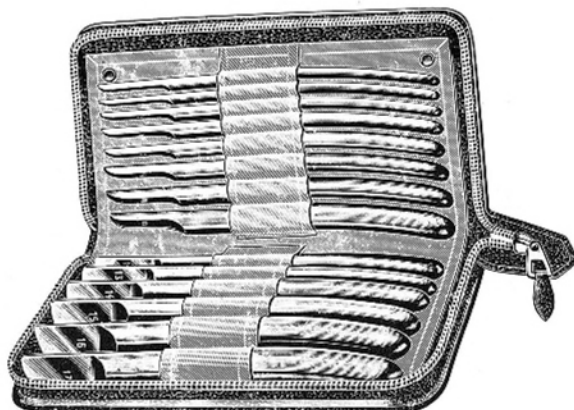

HEGAR

G14.60.0350.00 (4 to 17 mm dia)
set of 14

G14.60.0352.00 (1 to 26 mm dia)
set of 26

G14.60.0354.00 (1 to 30 mm dia)
set of 30

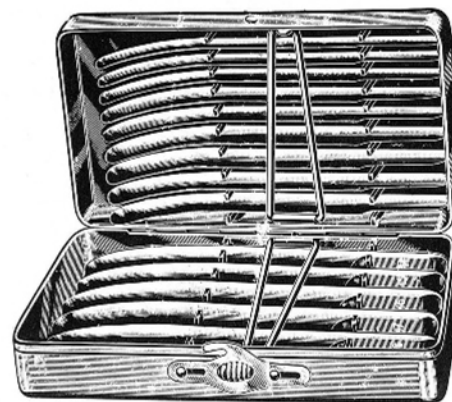

HEGAR

G14.60.0360.00 (4 to 17 mm dia)
set of 14

G14.60.0362.00 (1 to 26 mm dia)
set of 26

G14.60.0364.00 (1 to 30 mm dia)
set of 30

60.0364.00

60-015

www.g14surgical.com

60

EN Uterine Dilators

DE Uterus-Dilatatoren

ES Dilatadores uterinos



GYNECOLOGY



	mm dia.
G14.60.0370.01	1/2
G14.60.0370.03	3/4
G14.60.0370.05	5/6
G14.60.0370.07	7/8
G14.60.0370.09	9/10
G14.60.0370.11	11/12
G14.60.0370.13	13/14
G14.60.0370.15	15/16
G14.60.0370.17	17/18
G14.60.0370.19	19/20
G14.60.0370.21	21/22
G14.60.0370.23	23/24
G14.60.0370.25	25/26

HEGAR

G14.60.0370.01 - G14.60.0370.25
(1/2 - 25/26 mm dia.)

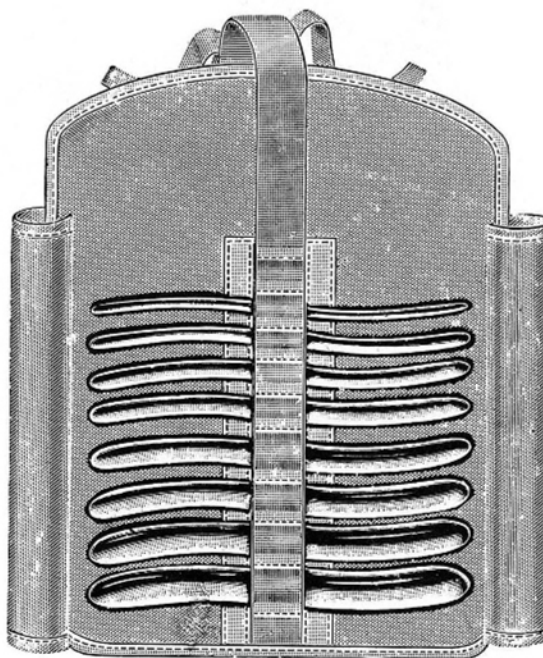

HEGAR

G14.60.0370.00 G14.60.0372.00
set of 8 set of 13
(3/4 to 17/18 mm dia) (1/2 to 25/26 mm dia)

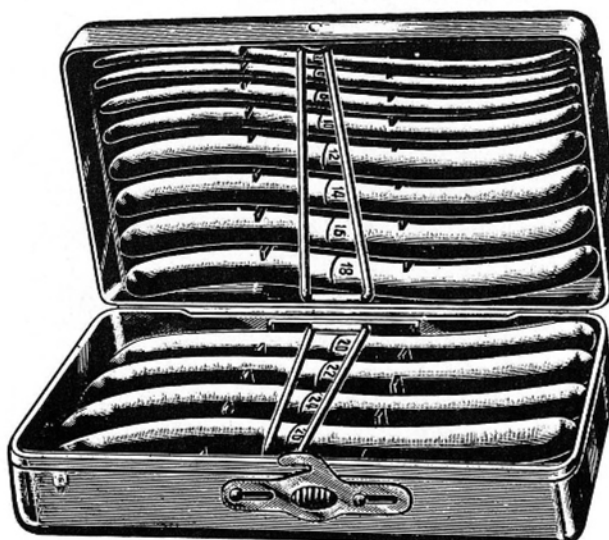

HEGAR

G14.60.0380.00 G14.60.0382.00
set of 8 set of 13
(3/4 to 17/18 mm dia) (1/2 to 25/26 mm dia)

60.0382.00

60-016

www.g14surgical.com

Uterine Dilators EN

Uterus-Dilatatoren DE

Dilatadores uterinos ES

60

GYNECOLOGY

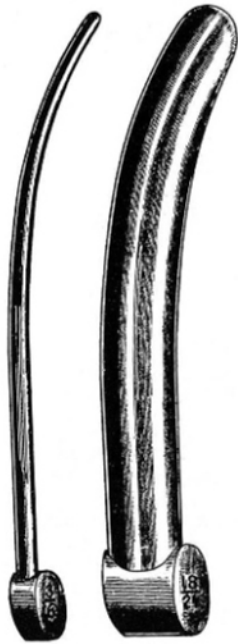

HAWKINS-AMBLER

G14.60.0390.00 set of 12

G14.60.0392.00 set of 16

	mm dia.
G14.60.0390.01	3/6
G14.60.0390.02	4/7
G14.60.0390.03	5/8
G14.60.0390.04	6/9
G14.60.0390.05	7/10
G14.60.0390.06	8/11
G14.60.0390.07	9/12
G14.60.0390.08	10/13
G14.60.0390.09	11/14
G14.60.0390.10	12/15
G14.60.0390.11	13/16
G14.60.0390.12	14/17
G14.60.0390.13	15/18
G14.60.0390.14	16/19
G14.60.0390.15	17/20
G14.60.0390.16	18/21



JOLLY

G14.60.0400.00 set of 5

G14.60.0400.01	3-7 mm dia
G14.60.0400.02	5-9 mm dia
G14.60.0400.03	7-12 mm dia
G14.60.0400.04	9-15 mm dia
G14.60.0400.05	12-18 mm dia



HANK

G14.60.0404.00 set

Fig.9/10	G14.60.0404.01	4,5/5 mm
Fig.11/12	G14.60.0404.02	5,5/6 mm
Fig.13/14	G14.60.0404.03	6,5/7 mm
Fig.15/16	G14.60.0404.04	7,5/8 mm
Fig.17/18	G14.60.0404.05	8,5/9 mm
Fig.19/20	G14.60.0404.06	9,5/10 mm

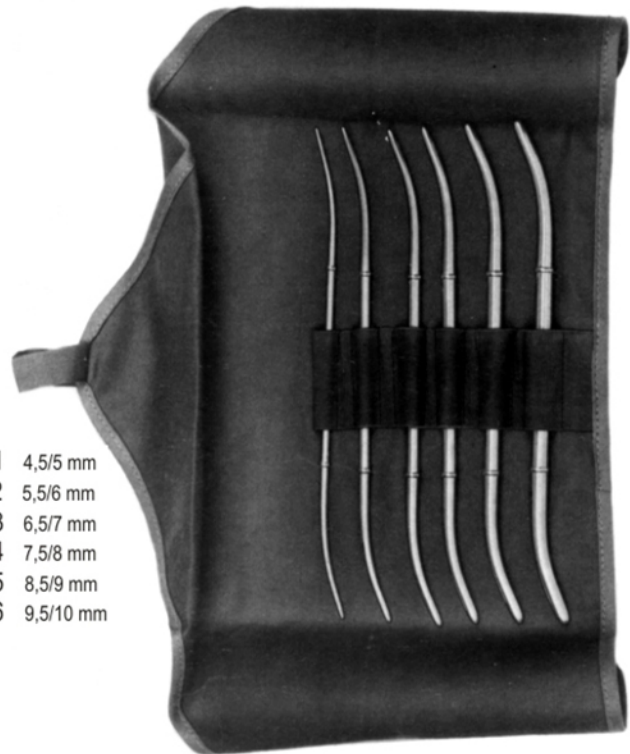

HANK

G14.60.0406.00 set

60.0406.00

60-017

www.g14surgical.com

60

EN Uterine Dilators

DE Uterus-Dilatatoren

ES Dilataores uterinos



GYNECOLOGY

mm

- 1 G14.60.0410.01
- 2 G14.60.0410.02
- 3 G14.60.0410.03
- 4 G14.60.0410.04
- 5 G14.60.0410.05
- 6 G14.60.0410.06
- 7 G14.60.0410.07
- 8 G14.60.0410.08
- 9 G14.60.0410.09
- 10 G14.60.0410.10
- 11 G14.60.0410.11
- 12 G14.60.0410.12
- 13 G14.60.0410.13
- 14 G14.60.0410.14
- 15 G14.60.0410.15
- 16 G14.60.0410.16
- 17 G14.60.0410.17
- 18 G14.60.0410.18
- 19 G14.60.0410.19
- 20 G14.60.0410.20



HEGAR set

- G14.60.0410.00 1 to 13mm
- G14.60.0412.00 1 to 20mm
- G14.60.0414.00 14 to 20mm

60.0414.00

60-018

www.g14surgicals.com

Uterine Dilators EN

Uterus-Dilatatoren DE

Dilatadores uterinos ES

60

GYNECOLOGY

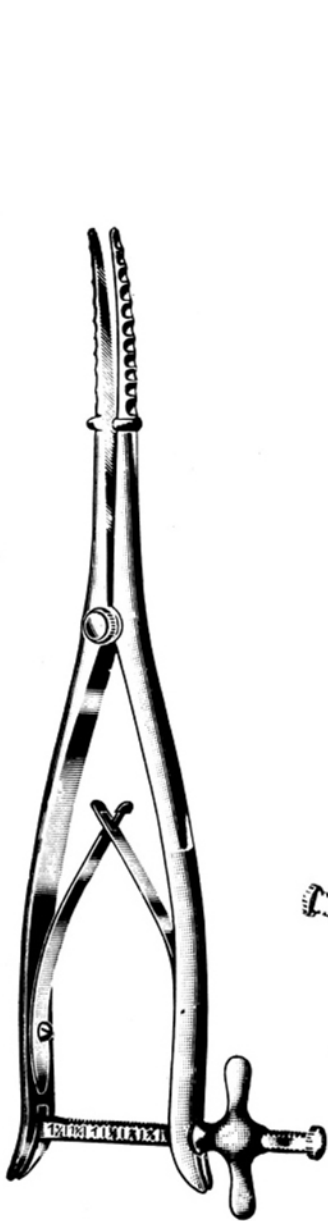

WYLIE

G14.60.0420.29 serrated
G14.60.0422.29 smooth
29.0cm

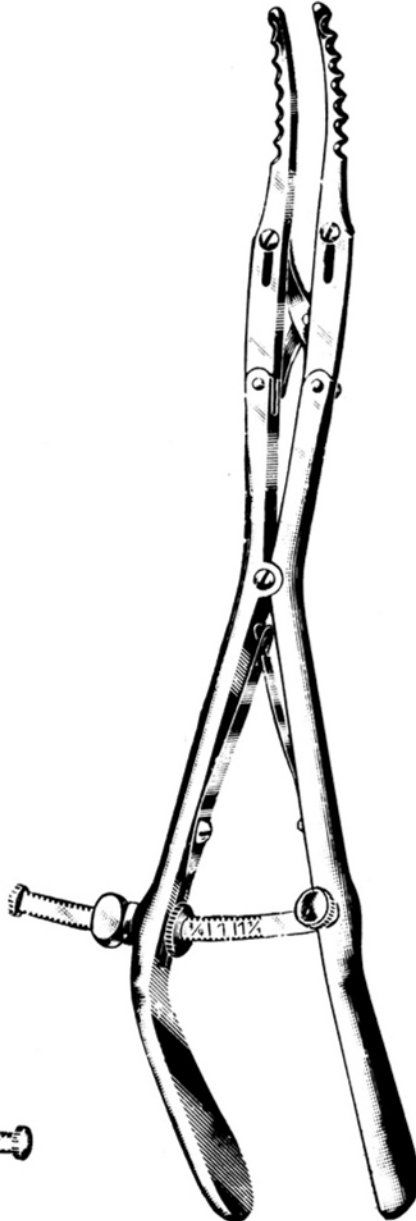

GOODELL

G14.60.0426.34 34.0cm

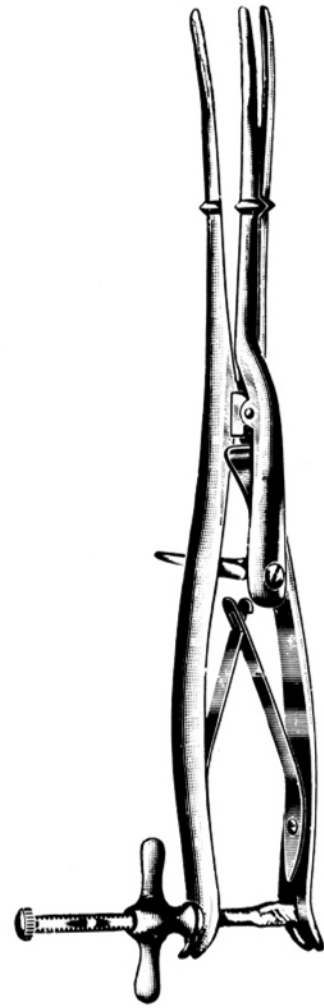

SIMS

G14.60.0430.29 29.0cm

60.0430.29

60-019

www.g14surgical.com

60

EN Uterine Depressors, Gauze Packer and Sponge Holder
DE Uterusdepressoren, Tamponstopfer und Schwammhalter
ES Depresores uterinos, Porta-tapones y esponjas



GYNECOLOGY



BRAUN

G14.60.0440.28 28.0cm



SIMS

G14.60.0444.26 26.0cm



FANO

G14.60.0450.22 22.0cm

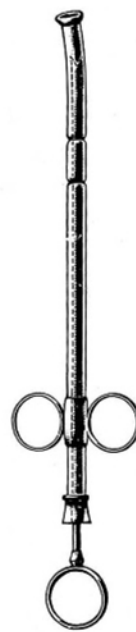

RAPID

G14.60.0454.01 200 x 8mm
G14.60.0454.02 250 x 10mm
G14.60.0454.03 250 x 12mm



SIMS

G14.60.0460.27 27.0cm

60.0460.27

60-020

www.g14surgical.com

Uterine Sounds EN

Uterussonden DE

Histerometros ES

60

GYNECOLOGY

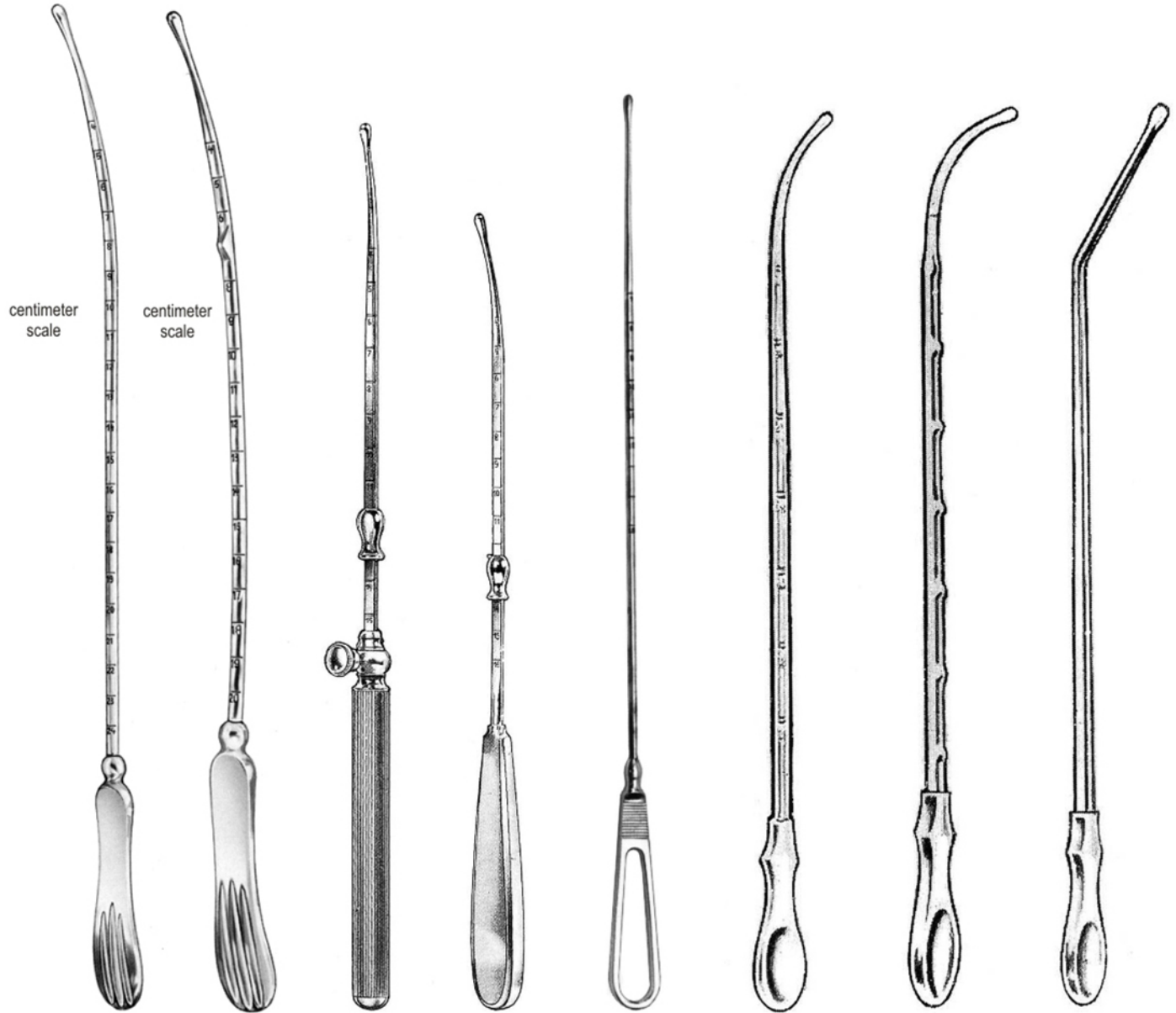

SIMS
32.0cm
G14.60.0470.32
rigid

G14.60.0472.32
malleable

MARTIN
32.0cm
G14.60.0476.32
rigid

G14.60.0478.32
malleable

COLLIN
G14.60.0480.28
28.0cm

VALLEIX
G14.60.0486.25
25.0cm

G14.60.0490.30
30.5cm

GALABIN
G14.60.0496.32
32.0cm

HORROCKS
G14.60.0500.32
32.0cm

SIMPSON
G14.60.0504.32
32.0cm

60.0504.32

60-021

www.g14surgical.com

60

EN Myoma Instruments

DE Myom-Instrumente

ES Instrumentos para fibroma



GYNECOLOGY



DOYEN
17.0cm

G14.60.0510.01 T-handle
G14.60.0510.02 loop handle



DOYEN
17.0cm

G14.60.0512.01 T-handle
G14.60.0512.02 loop handle



SEGOND

G14.60.0516.27 27.0cm

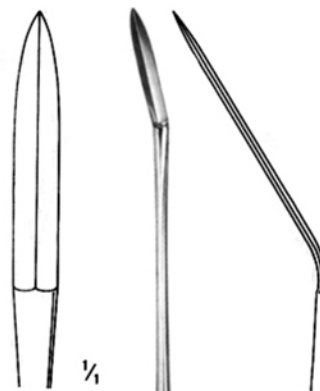

AYRE

G14.60.0520.23 23.0cm

60.0520.23

60-022

www.g14surgical.com

Fistula Hooks EN

Fistelhaken DE

Ganchos p/fistulas ES

60

GYNECOLOGY

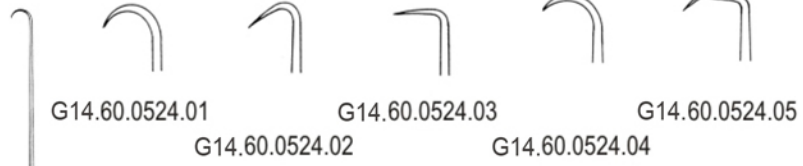

G14.60.0526.24 24.0cm



G14.60.0530.22 22.0cm



G14.60.0532.22 22.0cm

60.0532.22

60-023

www.g14surgical.com

60

EN Tenaculum Forceps

DE Hakenzangen

ES Pinzas para coger el cuello del utero



GYNECOLOGY



POZZI
G14.60.0540.25 25.0cm



POZZI
G14.60.0542.25 25.0cm

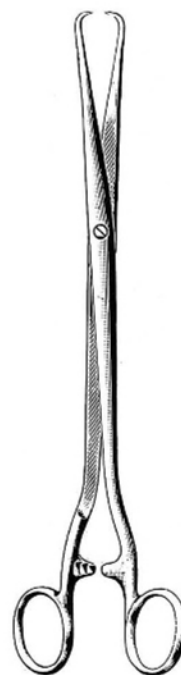

SCHROEDER
G14.60.0546.25 25.0cm



STAUDE-MOORE
G14.60.0550.17 17.0cm
strong pattern



BARRETT
G14.60.0554.18 18.0cm

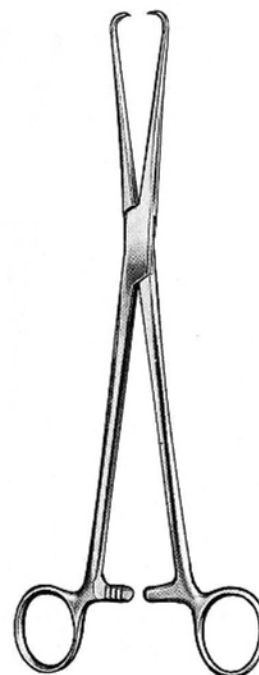

POZZI
G14.60.0560.25 25.5cm

60.0560.25

60-024

www.g14surgical.com

GYNECOLOGY



MARTIN
G14.60.0564.27 27.0cm



SKENE
G14.60.0570.24 24.0cm



SKENE
G14.60.0574.23 23.0cm



ABEL
G14.60.0576.27 27.0cm



SCHROEDER
G14.60.0580.25 25.0cm



BRAUN
G14.60.0584.25 25.0cm



DUPLAY
G14.60.0590.28 28.0cm



BEACHAM
G14.60.0594.26 26.0cm

60.0594.26

60-025

www.g14surgical.com

60

EN Tenaculum Forceps
DE Hakenzangen
ES Pinzas para coger el cuello del utero



GYNECOLOGY



G14.60.0601.23 23.0cm
G14.60.0601.24 24.0cm
G14.60.0601.26 26.0cm

SCHROEDER

G14.60.0600.23 23.0cm
G14.60.0600.24 24.0cm
G14.60.0600.26 26.0cm



G14.60.0603.23
G14.60.0603.24
G14.60.0603.26



G14.60.0607.26 26.0cm

SCHROEDER

G14.60.0606.26 26.0cm



TEALE

G14.60.0610.18 18.0cm
G14.60.0610.23 23.0cm



TEALE

G14.60.0614.18 18.0cm
G14.60.0614.23 23.0cm
G14.60.0614.25 25.0cm



IOWA

G14.60.0620.26 26.0cm

60.0620.26

60-026

www.g14surgical.com

Tenaculum Forceps EN

Hakenzangen DE

Pinzas para coger el cuello del utero ES

60

GYNECOLOGY



6mm



8mm



10mm

MUSEUX

straight	24.0cm	curved sideway
G14.60.0630.06	6mm	G14.60.0631.06
G14.60.0630.08	8mm	G14.60.0631.08
G14.60.0630.10	10mm	G14.60.0631.10

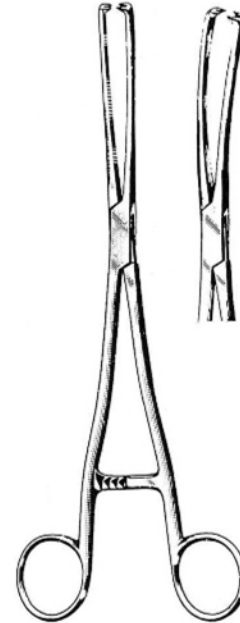

MUSEUX

straight	24.0cm	curved sideway
G14.60.0634.06	6mm	G14.60.0635.06
G14.60.0634.08	8mm	G14.60.0635.08
G14.60.0634.10	10mm	G14.60.0635.10



9mm



11mm



13mm

MUSEUX

straight	26.0cm	curved sideway
G14.60.0638.09	9mm	G14.60.0639.09
G14.60.0638.11	11mm	G14.60.0639.11
G14.60.0638.13	13mm	G14.60.0639.13

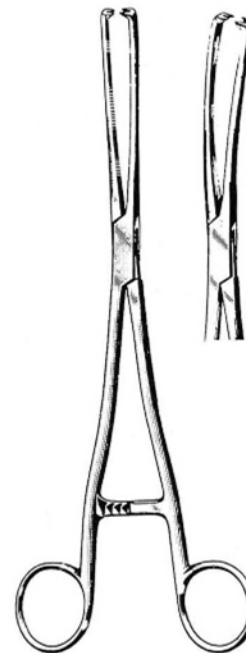

MUSEUX

straight	26.0cm	curved sideway
G14.60.0642.09	9mm	G14.60.0643.09
G14.60.0642.11	11mm	G14.60.0643.11
G14.60.0642.13	13mm	G14.60.0643.13

60.0643.13

60-027

www.g14surgical.com

- EN Tenaculum Forceps
- DE Hakenzangen
- ES Pinzas para coger el cuello del utero



GYNECOLOGY



JACOBS

G14.60.0646.21 21.0cm
G14.60.0647.21



HENROTIN

G14.60.0650.20 20.0cm



BRAUN

G14.60.0654.15 15.5cm



CZERNY

G14.60.0660.20 20.5cm



G14.60.0664.26 26.0cm

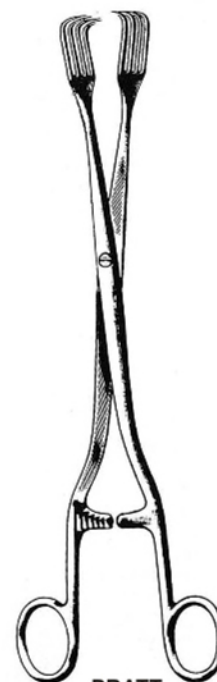

PRATT

G14.60.0668.28 28.0cm

60.0668.28

60-028

www.g14surgical.com

GYNECOLOGY



BONNEY
G14.60.0672.27 27.0cm



BONNEY
G14.60.0674.27 27.0cm



MAINGOT
G14.60.0676.20 20.0cm 60.0677.20
G14.60.0676.24 24.0cm 60.0677.24

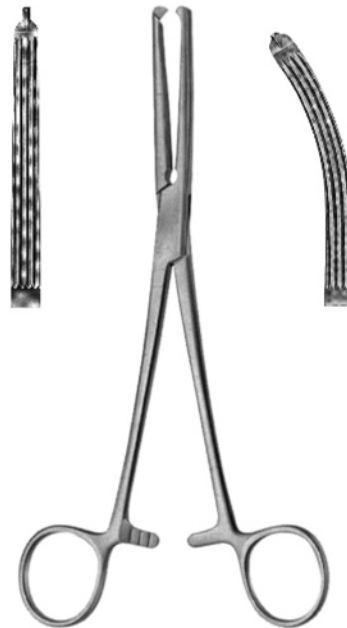

GWILLIAM
G14.60.0678.20 20.0cm G14.60.0679.20

60.0679.20

60-029

www.g14surgical.com

60

EN Uterine Polypus and Elevating Forceps

DE Uterus Polypen und Fasszangen

ES Pinzas para polipos el uterinos



GYNECOLOGY

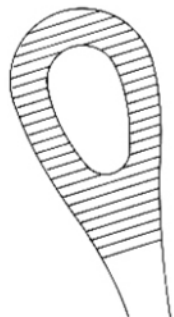

KELLY

G14.60.0684.32 32.0cm

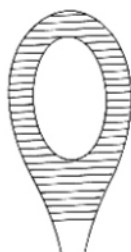

NOTO

G14.60.0690.27 27.0cm

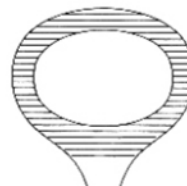

DOYEN

G14.60.0694.20 20.0cm



DARTIGUES

G14.60.0700.27 27.0cm



SOMER

G14.60.0704.23 23.0cm



PRUESMANN

G14.60.0710.27 27.5cm



COLLIN

G14.60.0714.25 25.0cm

60.0714.25

60-030

www.g14surgicals.com

GYNECOLOGY



THOMS-GAYLOR
G14.60.0750.24 24.0cm



THOMS-GAYLOR
G14.60.0754.22 22.0cm
G14.60.0754.24 24.0cm



VAN DOREN
24.0cm

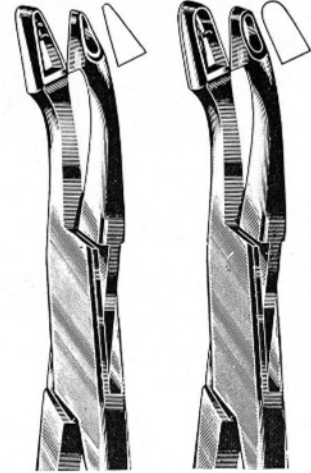

G14.60.0760.01 G14.60.0760.02



GELLHORN
G14.60.0764.23 23.0cm



FAURE
G14.60.0770.21 21.0cm

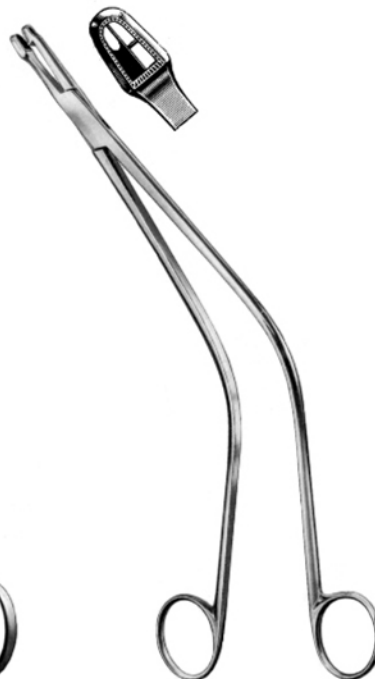

SCHUBERT
G14.60.0774.26 26.0cm



SCHUBERT
G14.60.0778.21 21.0cm
G14.60.0778.29 29.0cm

60.0778.29

60-031

www.g14surgical.com

60

EN Cervical Biopsy and Specimen Forceps

DE Probeexzisionszangen

ES Pinzas saca-bocados para biopsia



GYNECOLOGY

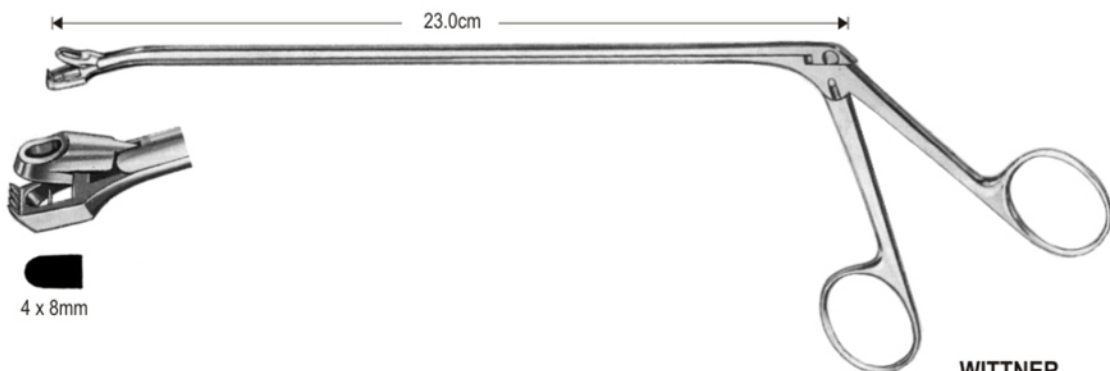

WITTNER

G14.60.0782.23 23.0cm (straight)
G14.60.0783.23 23.0cm (angled)

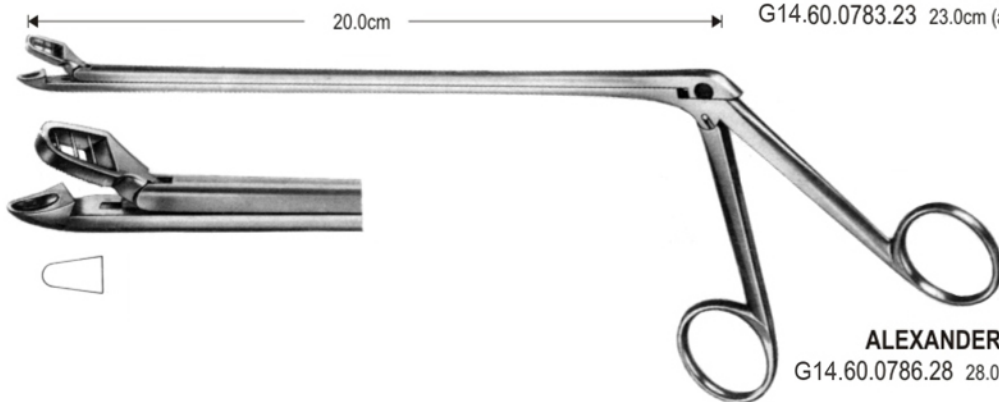

ALEXANDER

G14.60.0786.28 28.0cm

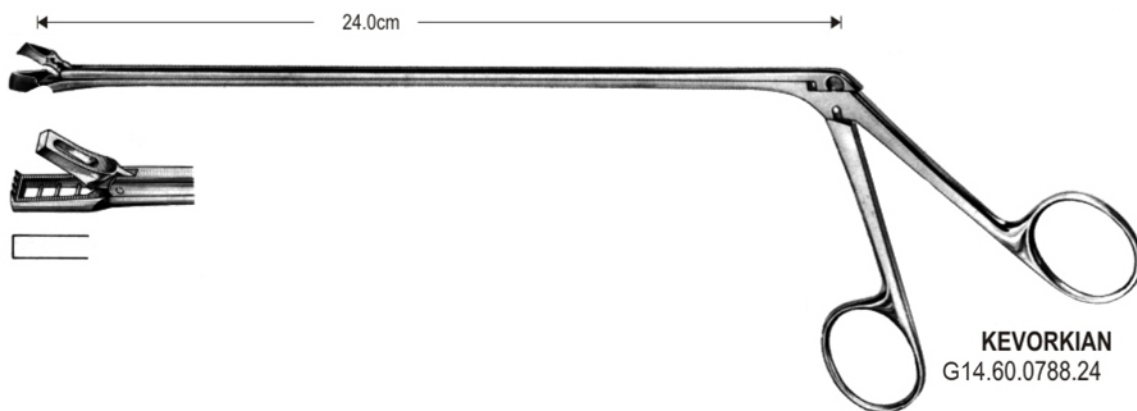

KEVORKIAN

G14.60.0788.24

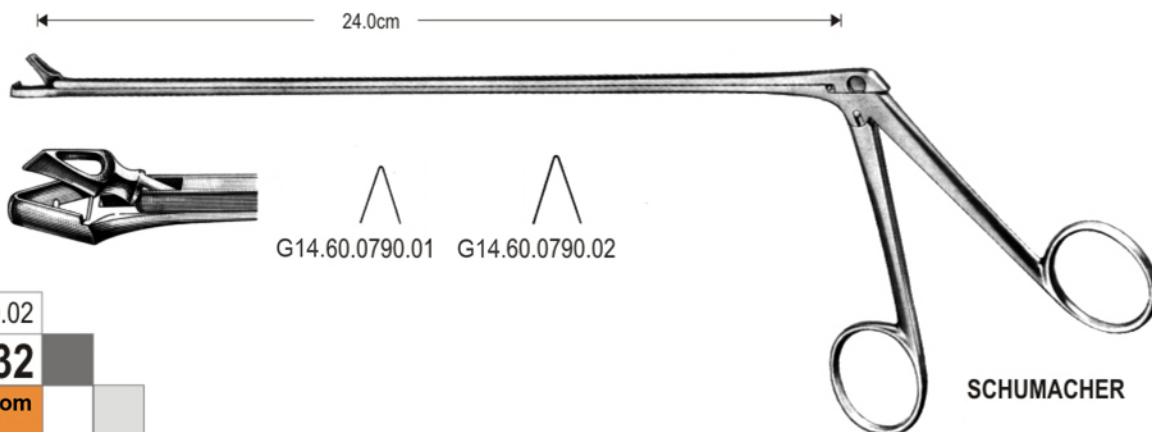

SCHUMACHER

60.0790.02

60-032

www.g14surgical.com

Cervical Biopsy and Specimen Forceps EN

Probeexzisionszangen DE

Pinzas saca-bocados para biopsia ES

60

GYNECOLOGY



2.3 x 4.2 mm



TOWNSEND-MINI
G14.60.0792.00



3 x 9.5 mm



TISCHLER-KEVORKIAN
G14.60.0794.00



4 x 6.5 mm

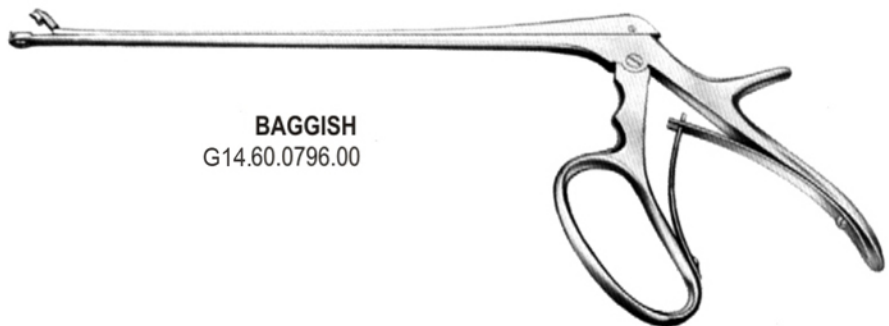

BAGGISH
G14.60.0796.00



4 x 8 mm

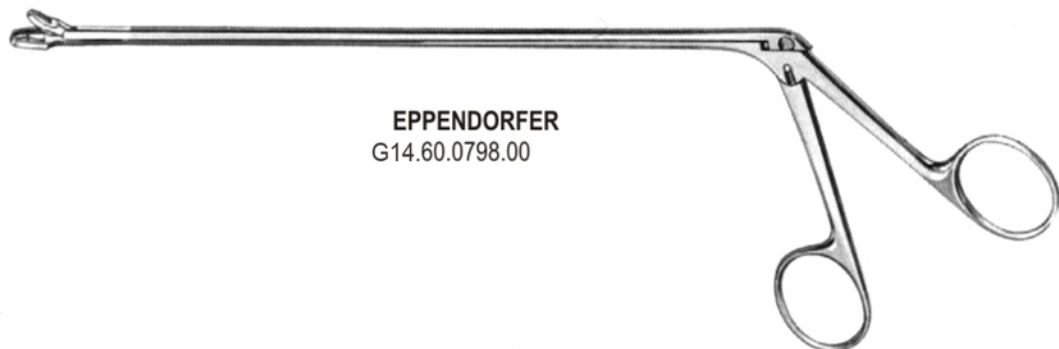

EPPENDORFER
G14.60.0798.00

60.0798.00

60-033

www.g14surgical.com



oval
7 x 5 mm

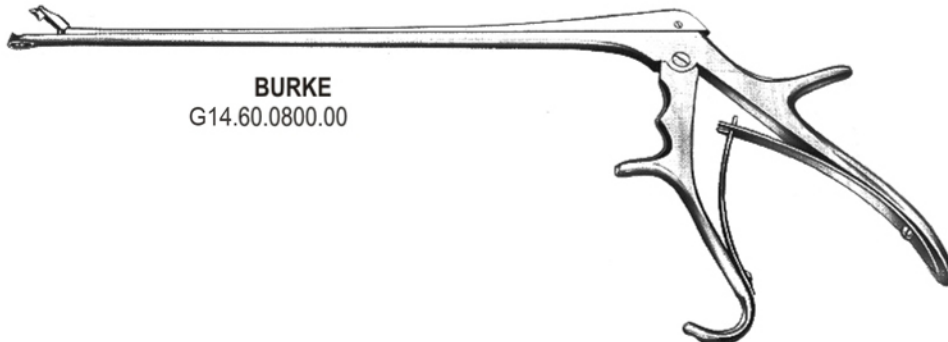

BURKE
G14.60.0800.00

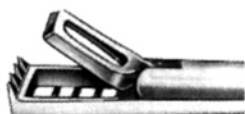

3 x 8 mm

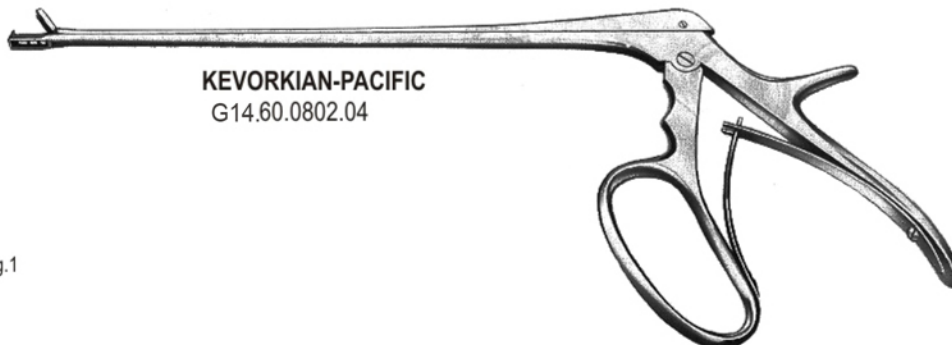

KEVORKIAN-PACIFIC
G14.60.0802.04



Fig.1

TISCHLER-MORGAN



oval ● 3.7 x 5 mm

Fig.3

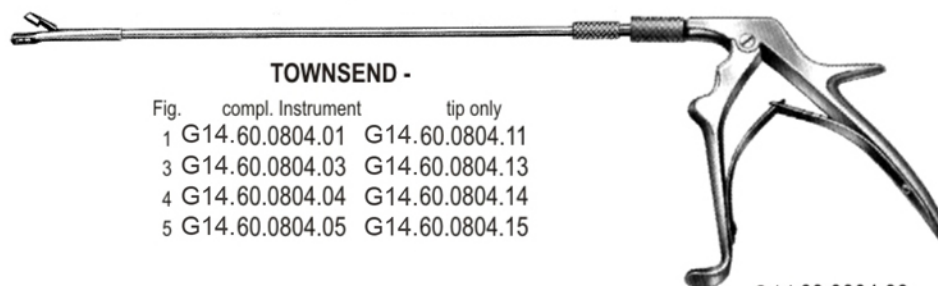

TOWNSEND -

Fig.	compl. Instrument	tip only
1	G14.60.0804.01	G14.60.0804.11
3	G14.60.0804.03	G14.60.0804.13
4	G14.60.0804.04	G14.60.0804.14
5	G14.60.0804.05	G14.60.0804.15

G14.60.0804.99
handle only



Fig.4

KEVORKIAN



Fig.5

mini



Tip only



SCHUMACHER
G14.60.0806.00



G14.60.0806.01

60.0806.01

60-034

www.g14surgical.com

Uterine Scoops EN

Uterusloffel DE

Cucharillas uterinas ES

60

GYNECOLOGY



G14.60.0820.01



G14.60.0820.02



G14.60.0820.03

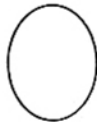

G14.60.0820.04



G14.60.0820.05

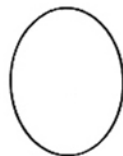

G14.60.0820.06



SIMON
25.0cm, sharp, rigid



G14.60.0824.01



G14.60.0824.02



G14.60.0824.03



G14.60.0824.04



G14.60.0824.05



G14.60.0824.06



SCHROEDER
30.0cm, sharp, rigid



G14.60.0830.01 G14.60.0830.02
6mm 8mm



G14.60.0830.03 G14.60.0830.04
10mm 12mm



G14.60.0830.05
14 mm



GOURDET
28.0cm, blunt

60.0830.05

60-035

www.g14surgical.com

GYNECOLOGY



SIMS
31.0cm

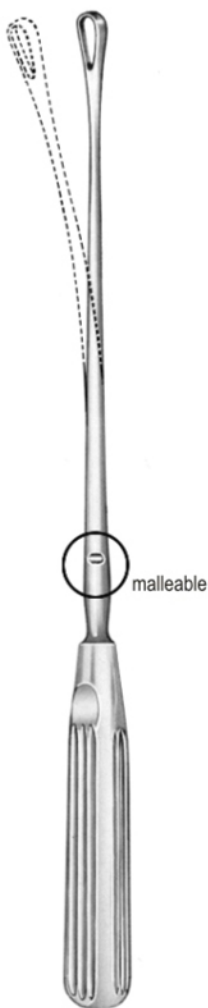

RECAMIER
31.0cm



Fig	sharp	blunt	sharp	blunt
00	G14.60.0840.05	G14.60.0842.05	G14.60.0844.05	G14.60.0846.05
0	G14.60.0840.06	G14.60.0842.06	G14.60.0844.06	G14.60.0846.06
1	G14.60.0840.07	G14.60.0842.07	G14.60.0844.07	G14.60.0846.07
2	G14.60.0840.08	G14.60.0842.08	G14.60.0844.08	G14.60.0846.08
3	G14.60.0840.09	G14.60.0842.09	G14.60.0844.09	G14.60.0846.09
4	G14.60.0840.11	G14.60.0842.11	G14.60.0844.11	G14.60.0846.11
5	G14.60.0840.12	G14.60.0842.12	G14.60.0844.12	G14.60.0846.12
6	G14.60.0840.14	G14.60.0842.14	G14.60.0844.14	G14.60.0846.14
7	G14.60.0840.15	G14.60.0842.15	G14.60.0844.15	G14.60.0846.15
8	G14.60.0840.16	G14.60.0842.16	G14.60.0844.16	G14.60.0846.16
9	G14.60.0840.19	G14.60.0842.19	G14.60.0844.19	G14.60.0846.19
10	G14.60.0840.20	G14.60.0842.20	G14.60.0844.20	G14.60.0846.20
11	G14.60.0840.21	G14.60.0842.21	G14.60.0844.21	G14.60.0846.21
12	G14.60.0840.23	G14.60.0842.23	G14.60.0844.23	G14.60.0846.23
13	G14.60.0840.25	G14.60.0842.25	G14.60.0844.25	G14.60.0846.25
14	G14.60.0840.30	G14.60.0842.30	G14.60.0844.30	G14.60.0846.30
15	G14.60.0840.35	G14.60.0842.35	G14.60.0844.35	G14.60.0846.35
16	G14.60.0840.40	G14.60.0842.40	G14.60.0844.40	G14.60.0846.40

Fig	sharp	blunt	sharp	blunt
00	G14.60.0850.05	G14.60.0852.05	G14.60.0854.05	G14.60.0856.05
0	G14.60.0850.06	G14.60.0852.06	G14.60.0854.06	G14.60.0856.06
1	G14.60.0850.07	G14.60.0852.07	G14.60.0854.07	G14.60.0856.07
2	G14.60.0850.08	G14.60.0852.08	G14.60.0854.08	G14.60.0856.08
3	G14.60.0850.09	G14.60.0852.09	G14.60.0854.09	G14.60.0856.09
4	G14.60.0850.11	G14.60.0852.11	G14.60.0854.11	G14.60.0856.11
5	G14.60.0850.12	G14.60.0852.12	G14.60.0854.12	G14.60.0856.12
6	G14.60.0850.14	G14.60.0852.14	G14.60.0854.14	G14.60.0856.14
7	G14.60.0850.15	G14.60.0852.15	G14.60.0854.15	G14.60.0856.15
8	G14.60.0850.16	G14.60.0852.16	G14.60.0854.16	G14.60.0856.16
9	G14.60.0850.19	G14.60.0852.19	G14.60.0854.19	G14.60.0856.19
10	G14.60.0850.20	G14.60.0852.20	G14.60.0854.20	G14.60.0856.20
11	G14.60.0850.21	G14.60.0852.21	G14.60.0854.21	G14.60.0856.21
12	G14.60.0850.23	G14.60.0852.23	G14.60.0854.23	G14.60.0856.23
13	G14.60.0850.25	G14.60.0852.25	G14.60.0854.25	G14.60.0856.25
14	G14.60.0850.30	G14.60.0852.30	G14.60.0854.30	G14.60.0856.30
15	G14.60.0850.35	G14.60.0852.35	G14.60.0854.35	G14.60.0856.35
16	G14.60.0850.40	G14.60.0852.40	G14.60.0854.40	G14.60.0856.40

60.0856.40

60-036

Uterine Curettes EN

Uteruskuretten DE

Curetas uterinas ES

60

GYNECOLOGY

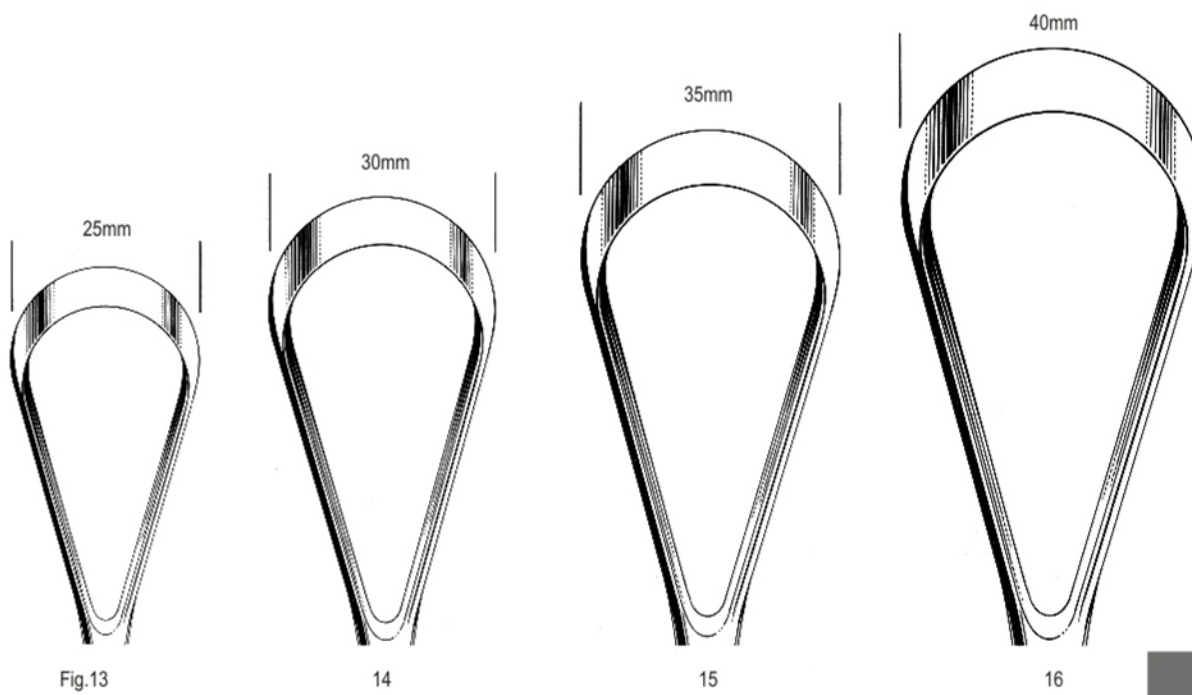
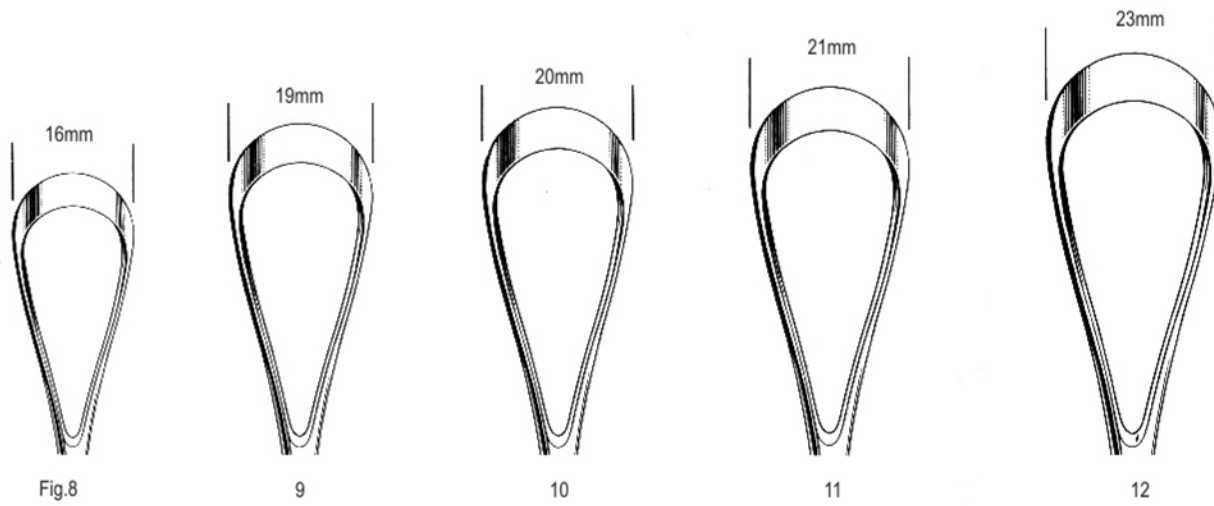
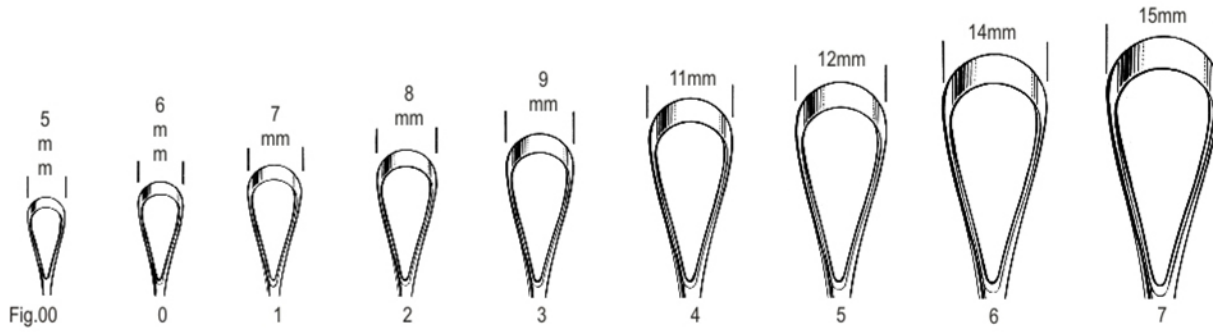

60.0856.40

60-037

www.g14surgical.com

60

EN Uterine Curettes

DE Uteruskuretten

ES Curetas uterinas



GYNECOLOGY



BUMM
34.0cm



Fig. 13

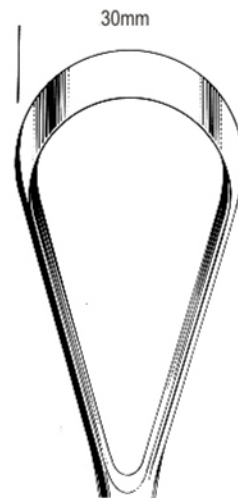

14

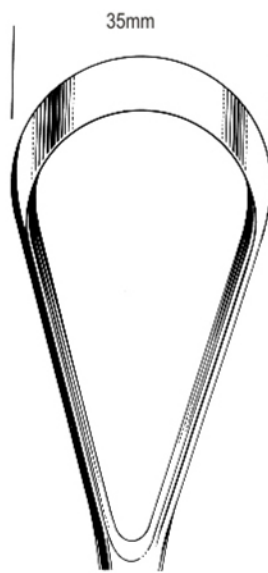

15

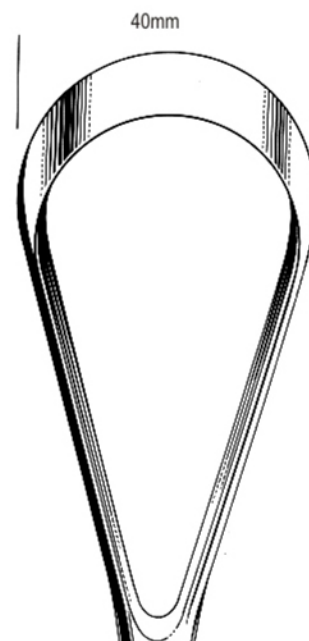

16

Fig	sharp	blunt	sharp	blunt
13	G14.60.0860.25	G14.60.0862.25	G14.60.0864.25	G14.60.0866.25
14	G14.60.0860.30	G14.60.0862.30	G14.60.0864.30	G14.60.0866.30
15	G14.60.0860.35	G14.60.0862.35	G14.60.0864.35	G14.60.0866.35
16	G14.60.0860.40	G14.60.0862.40	G14.60.0864.40	G14.60.0866.40

60.0866.40

60-038

www.g14surgical.com

Uterine Curettes EN

Uteruskuretten DE

Curetas uterinas ES

60

GYNECOLOGY

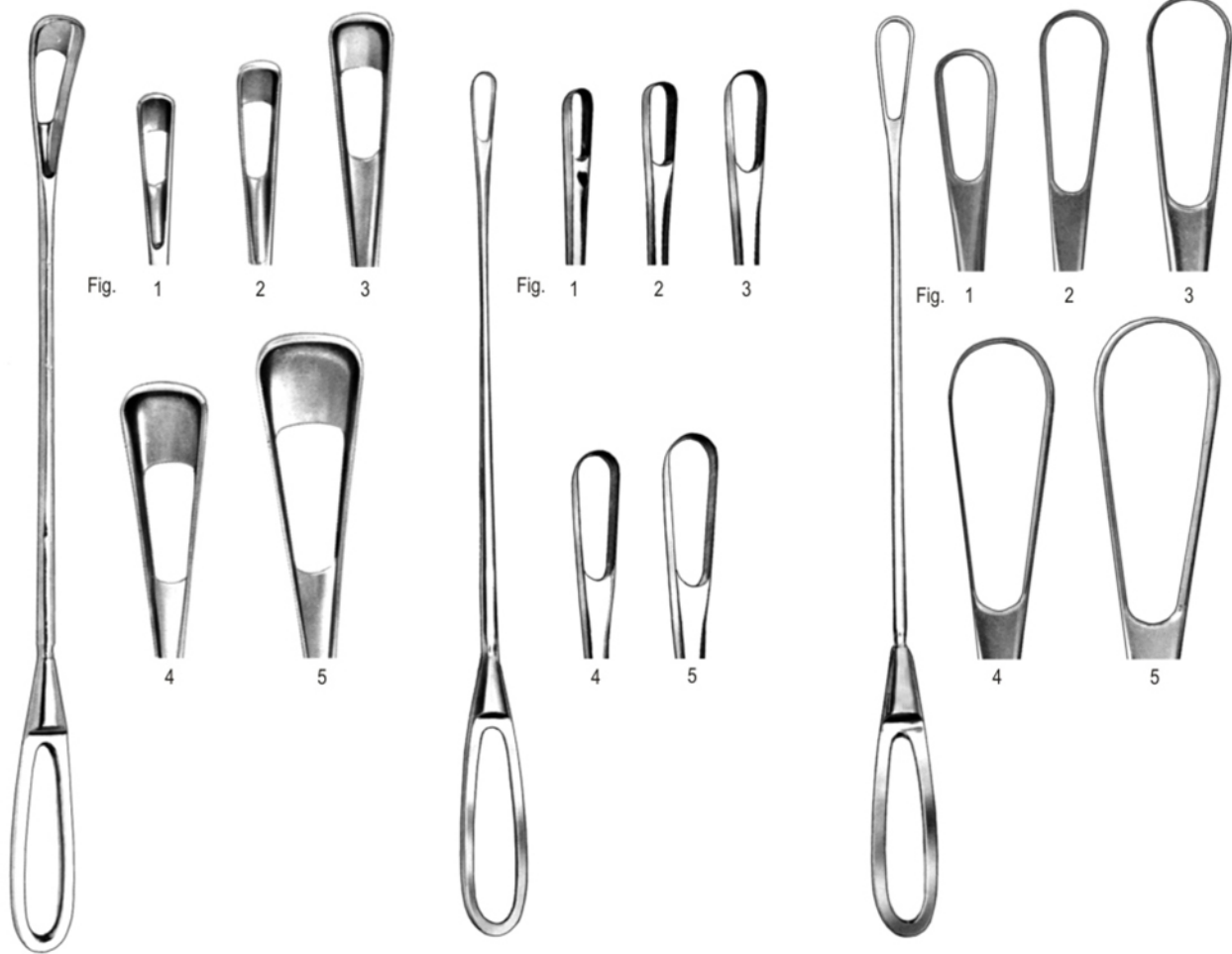

28.0cm

Fig.		mm
1	G14.60.0870.01	4.5
2	G14.60.0870.02	6
3	G14.60.0870.03	9
4	G14.60.0870.04	12
5	G14.60.0870.05	15

OLSHAUSEN'S
27.0cm

Fig.	
1	G14.60.0874.01
2	G14.60.0874.02
3	G14.60.0874.03
4	G14.60.0874.04
5	G14.60.0874.05

BUMM'S
28.0cm

Fig.	
1	G14.60.0878.01
2	G14.60.0878.02
3	G14.60.0878.03
4	G14.60.0878.04
5	G14.60.0878.05

60.0878.05

60-039

www.g14surgical.com

EN Uterine Curettes

DE Uteruskuretten

ES Curetas uterinas



GYNECOLOGY

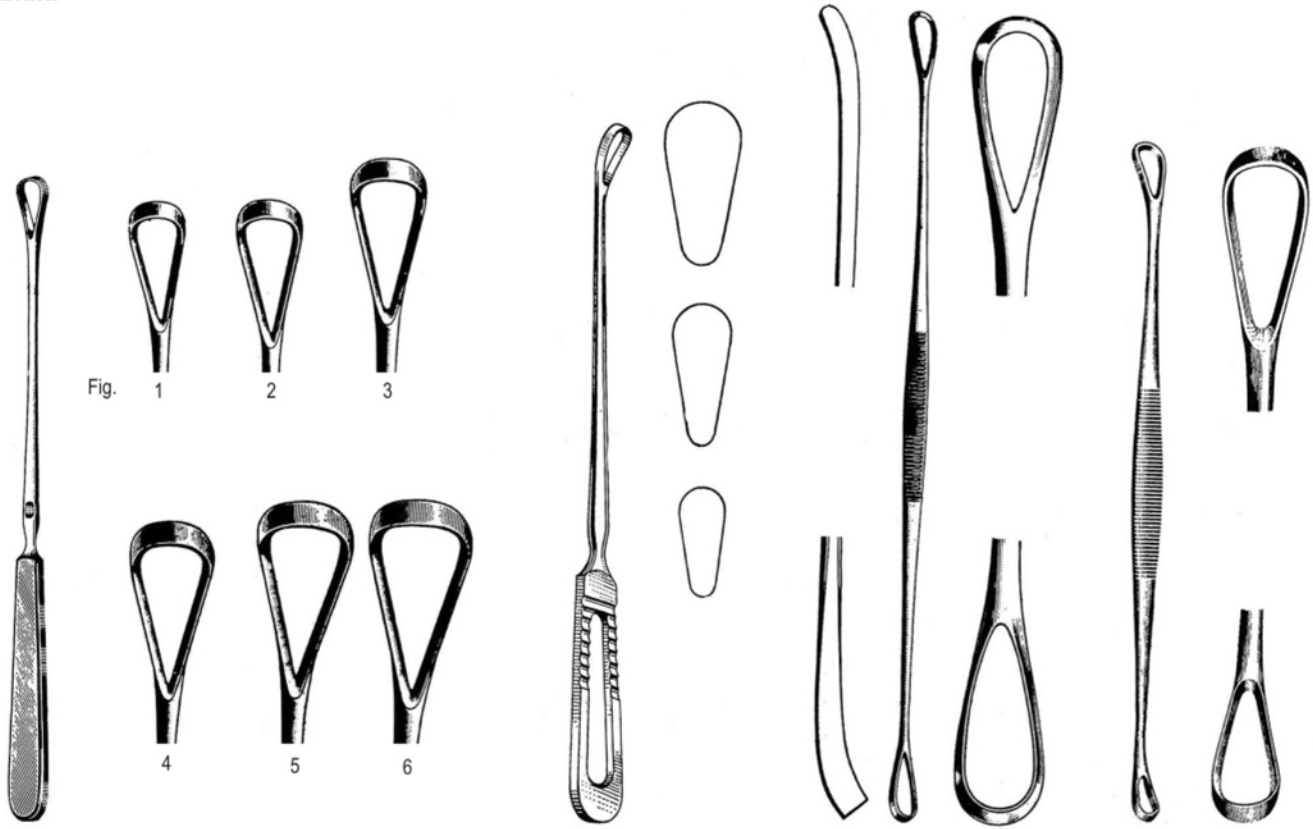

SIMS
25.0cm

sharp	Fig	blunt
G14.60.0880.01	1	G14.60.0882.01
G14.60.0880.02	2	G14.60.0882.02
G14.60.0880.03	3	G14.60.0882.03
G14.60.0880.04	4	G14.60.0882.04
G14.60.0880.05	5	G14.60.0882.05
G14.60.0880.06	6	G14.60.0882.06

SIMS
25.0cm

sharp	Fig	blunt
G14.60.0884.01	1	G14.60.0886.01
G14.60.0884.02	2	G14.60.0886.02
G14.60.0884.03	3	G14.60.0886.03

sharp / blunt
G14.60.0890.27 27.0cm

BLAKE
sharp / blunt
G14.60.0894.27 27.0cm



SIMS
G14.60.0900.25
25.0cm, sharp



SIMS
G14.60.0902.25
25.0cm, sharp / blunt



60.0902.25

60-040

www.g14surgical.com

Uterine Currettes EN

Uteruskurretten DE

Curetas uterinas ES

60

GYNECOLOGY

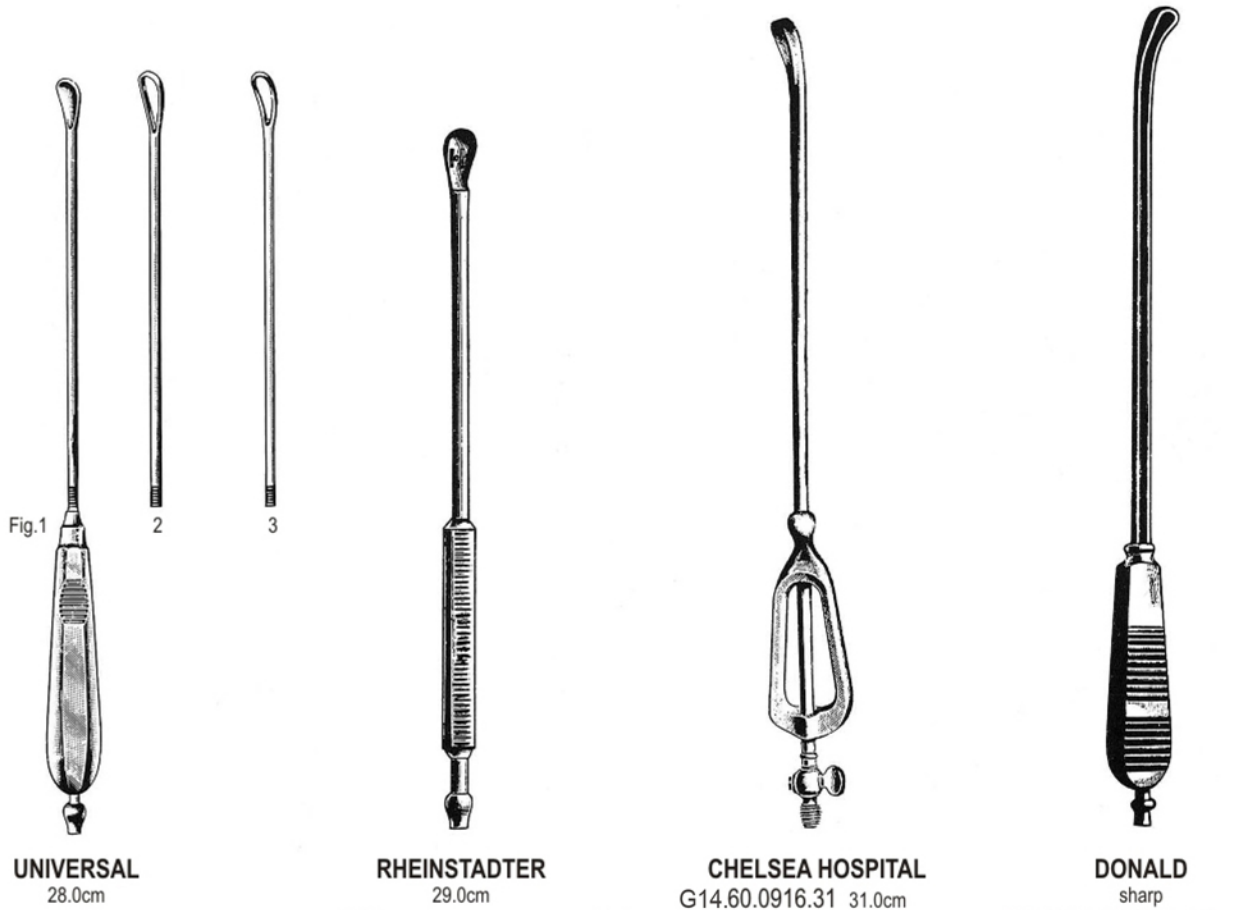

Fig.1

UNIVERSAL
28.0cm

Fig

- 1 G14.60.0906.01
- 2 G14.60.0906.02
- 3 G14.60.0906.03

RHEINSTADTER
29.0cm

- | | | | |
|----------------|---------|----------------|-------|
| | sharp | | blunt |
| G14.60.0910.01 | 7.9 mm | G14.60.0912.01 | |
| G14.60.0910.02 | 11.1 mm | G14.60.0912.02 | |
| G14.60.0910.03 | 14.3mm | G14.60.0912.03 | |

CHELSEA HOSPITAL
G14.60.0916.31 31.0cm

DONALD
sharp
G14.60.0920.33 33.0cm

60.0920.33

60-041

www.g14surgical.com

60

EN Suction Biopsy Curettes
DE Saug und Biopsiekuretten
ES Curetas aspiradores para biopsia



GYNECOLOGY



RANDALL
24.0cm

G14.60.0924.01 1mm dia.
G14.60.0924.02 2mm dia.
G14.60.0924.03 3mm dia.
G14.60.0924.04 4mm dia.



NOVAK
23.0cm

G14.60.0930.01
G14.60.0930.02
G14.60.0930.03
G14.60.0930.04



SHERMAN

G14.60.0934.23 23.0cm
3.5mm dia.

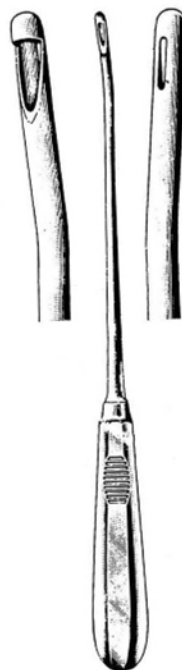

MUENCHEN

G14.60.0940.27 27.0cm

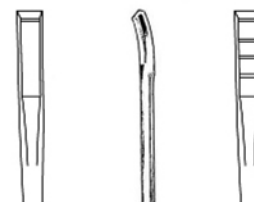

with basket



KEVORKIAN

30.0cm
G14.60.0944.12 1.2mm G14.60.0946.12
G14.60.0944.40 4.0mm G14.60.0946.40

60.0946.40

60-042

www.g14surgicals.com