







	Page #	
Table of Contents		
<b>Diagnostic, Anaesthesia and other instruments</b>	<b>1-10</b>	
<b>Scalpels, Knives and Scalpels Handles</b>	<b>11-14</b>	
<b>Scissors</b>	<b>15-31</b>	
<b>Dissecting-and Tissue Forceps</b>	<b>32-42</b>	
<b>Sponge, Dressing and Tissue Grasping Forceps Towel Clamps</b>	<b>43-48</b>	
<b>Vessel Clips, Bulldog Clamps Haemostatics Forceps</b>	<b>49-57</b>	
<b>Ligature, Hystarectomy and Compression Forceps Vaginal Clamps</b>	<b>58-60</b>	
<b>Needle Holders, Suture Instruments</b>	<b>61-65</b>	

Table of Contents

**Probes, pocket Instruments Sets**

**Page #**

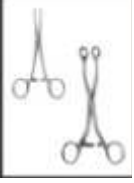
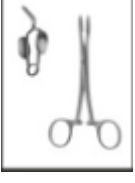
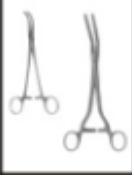
**66-68**



**Wound Retractors**

**69-80**

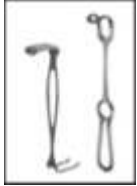

**Self-Retaining Retractors  
Abdominal Retractors**

**81-85**



**Abdominal Surgery Intestinal and Rectal  
Instruments**

**86-93**

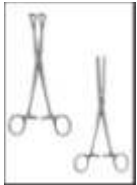

**Gall Bladder- Liver and Spleen Instruments**

**94-96**

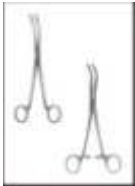

**Genito-Urinary Instruments and Trocars**

**97-100**



**Vaginal Specula and Uterine Dilators**

**101-106**



**Uterine Probes, Uterine Dressing,  
Polypus-and Ovum Forceps**

**107-109**

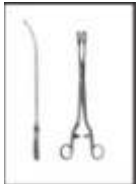

## Table of Contents







	Page #	
<b>Biopsy Instruments and Curettes</b>	<b>110-116</b>	
<b>Obstetrics and Tracheotomy</b>	<b>117-119</b>	
<b>Cardiovascular-and- Thoracic Surgery</b>	<b>120-128</b>	
<b>Bone Punches, Rongeurs</b>	<b>129-134</b>	
<b>Elevators, Bone Levers, Raspatories Bone Files, Bone Curettes</b>	<b>135-139</b>	
<b>Mallets, Chisels and Gouges</b>	<b>140-141</b>	
<b>Bone Holding Forceps, Bone Rongeurs Bone Cutting Forceps</b>	<b>142-148</b>	
<b>Plaster Instruments</b>	<b>149-157</b>	

Table of Contents

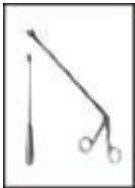
**Suction Instruments**

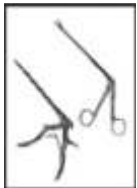
Page #

**158-166**



**Hospital Wares**

**167-174**



**TC Instruments**

**175-187**



Percussion Hammers and Aesthesiometers



Stethoscopes



01-110  
PINARD (Aluminum)  
Size: 155 mm



01-111  
wooden  
Size: 145 mm



01-112  
BOWLES  
Stethoscope  
with diaphragm



01-113  
ANESTOPHON



01-114  
FORD-BOWLES  
Dual chest piece  
with two outlets



01-115  
BOWLES

Head Mirrors and Head Bands



**01-116**  
ZIEGLER Ø 90mm  
head mirror only  
with rubber coating



**01-117**  
ZIEGLER Ø 90mm  
head mirror only  
with metal coating



**01-118**  
ZIEGLER  
head band of plastic black

**01-119**  
ZIEGLER  
head band of plastic white



**01-120**  
MURPHY  
head band of celluloid, white



**01-121**  
head band of plastic,  
white, soft pattern



**01-122**  
head mirror with black  
plastic head band.

Tongue Depressors

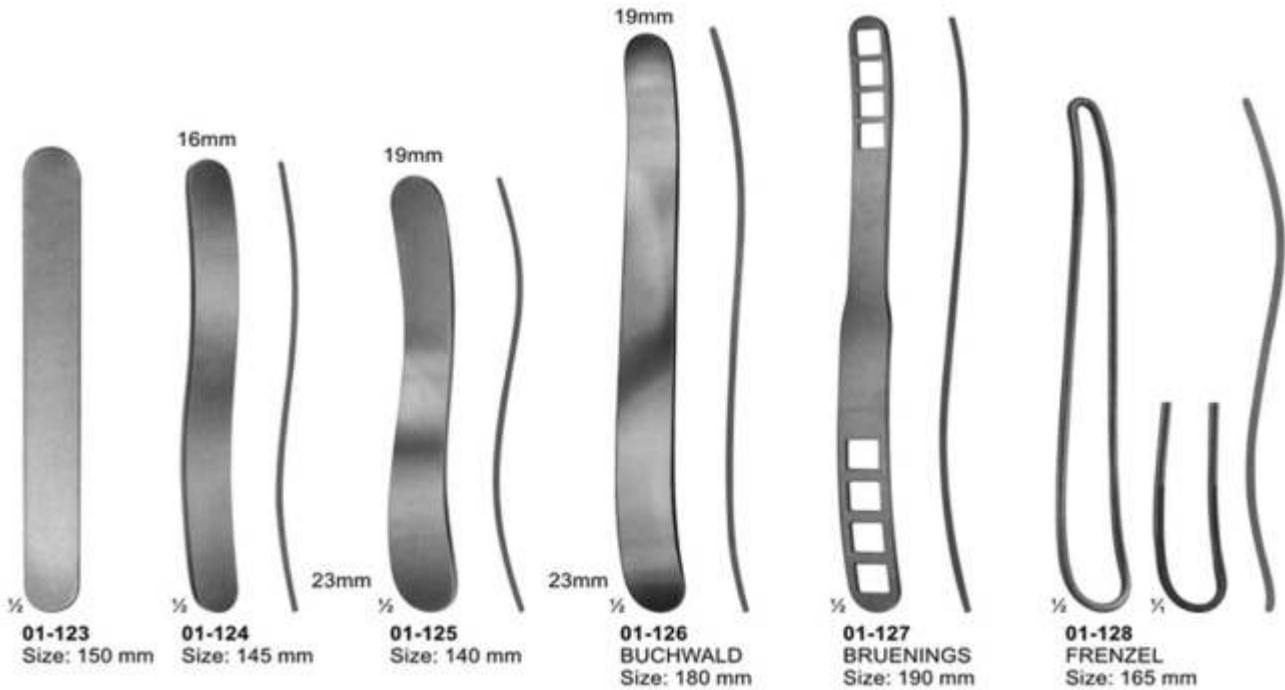

Instruments for Anaesthesia  
and Tongue Forceps



01-134  
SCHIMMELBUSCH  
Ether mask



01-135  
HEISTER  
Mouth gag  
Size: 130 mm



01-136  
FERGUSON-ACKLAND  
Mouth gag  
Size: 145 mm



01-137  
DENHARDT  
Mouth gag with silicon  
inserts, interchangeable  
Size: 125 mm



01-138  
ROSER KOENIG  
Mouth gag  
Size: 160 mm, 185 mm



1/2  
1 Pair Of  
Rubber Pads

01-139  
YOUNG  
Size: 165 mm

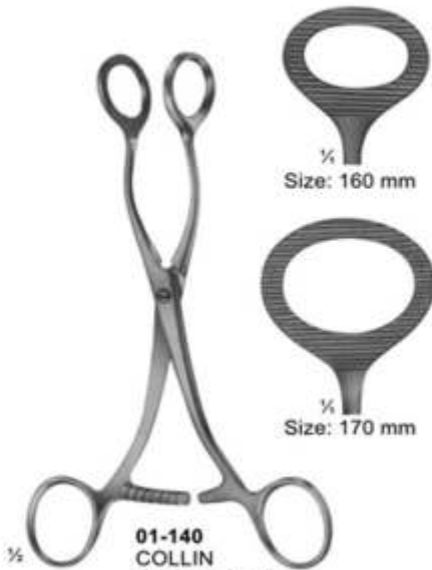

1/2  
Size: 160 mm

1/2  
Size: 170 mm

01-140  
COLLIN  
Size: 160 mm,  
170 mm



1/2

01-141  
HEYWOOD-SMITH  
modif. Size: 215 mm

Blood Lancets and Laryngeal Mirrors

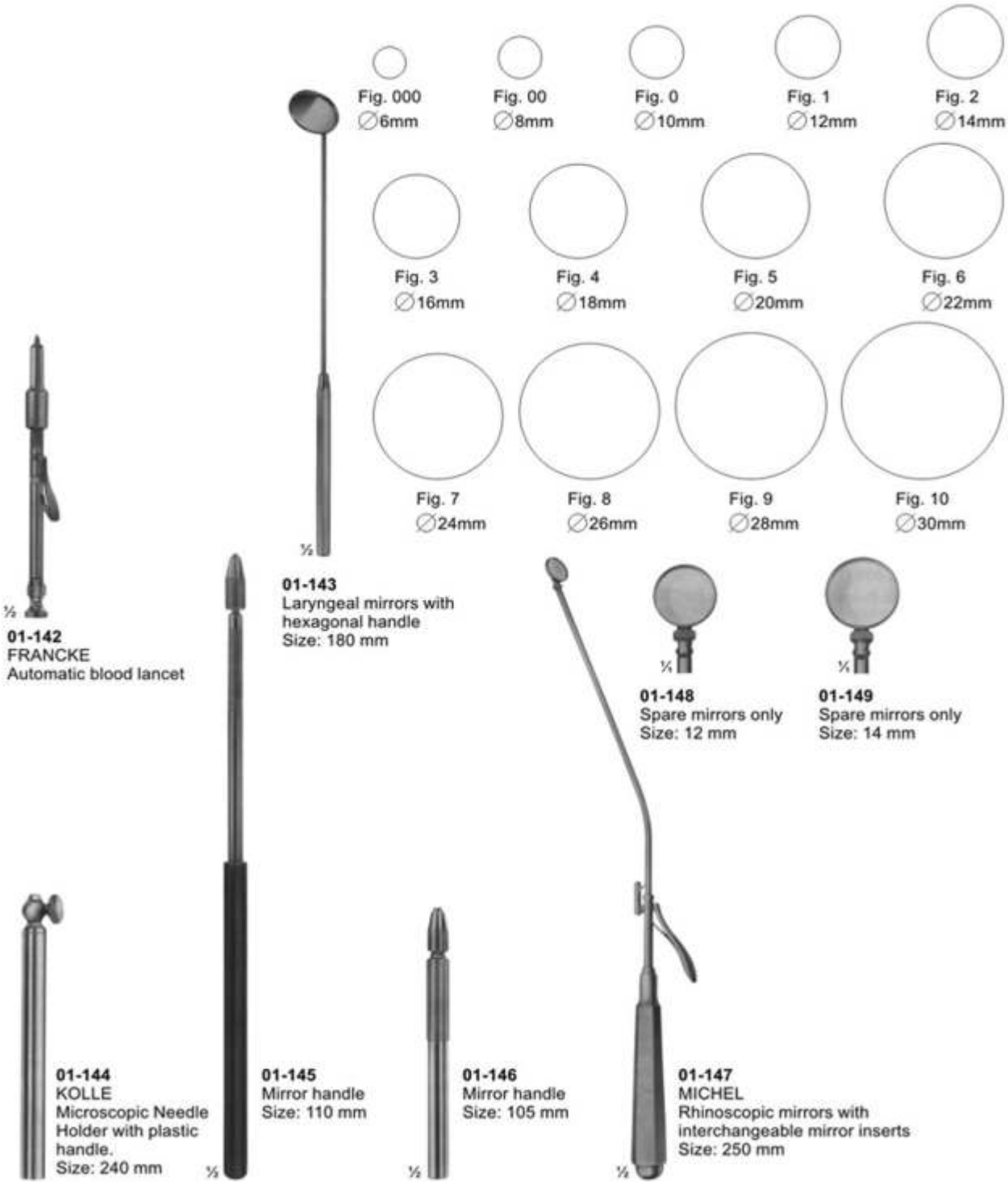

## Laryngoscope and Diagnostic Sets



$\frac{1}{8}$   
**01-150**  
Infants  
Size: 150 mm

$\frac{1}{4}$   
**01-151**  
Children  
Size: 200 mm

$\frac{1}{2}$   
**01-152**  
Adults  
Size: 250 mm

$\frac{1}{2}$   
**01-150 - 152**  
MAGILL



**01-154**



$\frac{1}{2}$   
**01-153**  
Medium battery handle  
only, 25 mm diam.



**01-153-A**  
Spare bulb  
2.7 volt, for  
otoscopes



**01-153-B**  
Spare bulb  
2.6 volt, for  
ophthalmoscopes



**01-155**



**01-156**  
Otoscope set, consists of  
battery handle without batteries,  
3 ear specula, 1 bulb in velvet lined case



**01-157**  
Diagnostic set, otoscope with three specula,  
nasal speculum, lamp holder, two laryngeal  
mirrors, tongue blade holder

Laryngoscopes



01-158 MILLER Laryngoscope set, consists of battery handle ( without battery ) with four miller laryngoscope blades

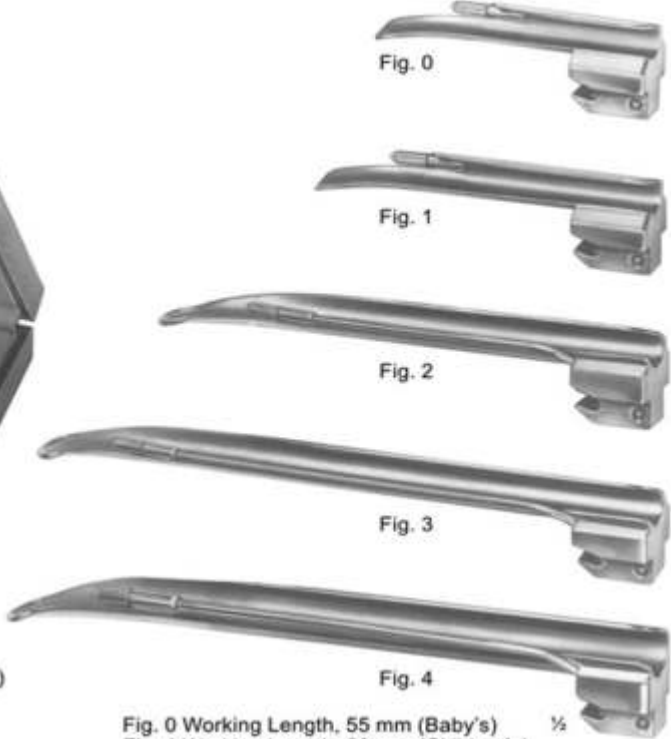

Fig. 0 Working Length, 55 mm (Baby's)
Fig. 1 Working Length, 80 mm (Children's)
Fig. 2 Working Length, 130 mm (Adolescent's)
Fig. 3 Working Length, 170 mm (Women's)
Fig. 4 Working Length, 180 mm (Men's)



01-159 GUEDEL-NEGUS Laryngoscope set, consists of battery handle ( without battery ) with four miller laryngoscope blades



Fig. 1 Working Length, 70 mm (Children's)
Fig. 2 Working Length, 90 mm (Adolescent's)
Fig. 3 Working Length, 110 mm (Women's)
Fig. 4 Working Length, 135 mm (Men's)

## Laryngoscopes



G14  
**01-160**  
 McINTOSH  
 Laryngoscope Set, Consists Of Battery Handle ( Without Battery )  
 With Three McIntosh Blades, Fig. 1, Fig. 2, Fig. 3

**01-161**  
 McINTOSH  
 Laryngoscope Set, Consists Of Battery Handle ( Without Battery )  
 With Five McIntosh Blades, Fig. 0, Fig. 1, Fig. 2, Fig. 3, Fig. 4



**01-162**  
 FOREGGER  
 Laryngoscope Set, Consists Of  
 Battery Handle ( Without Battery )  
 With Three Foregger Blades,  
 Fig. 1, Fig. 2, Fig. 3,

**01-163**  
 FOREGGER  
 Laryngoscope Set, Consists Of  
 Battery Handle ( Without Battery )  
 With Four Foregger Blades,  
 Fig. 1, Fig. 2, Fig. 3, Fig. 4,



Fig. 0



Fig. 1



Fig. 2



Fig. 3



Fig. 4

01-161 A Fig. 0 Working Length, 55 mm (Baby's)  
 01-161 B Fig. 1 Working Length, 75 mm (Children's)  
 01-161 C Fig. 2 Working Length, 90 mm (Adolescent's)  
 01-161 D Fig. 3 Working Length, 110 mm (Women's)  
 01-161 E Fig. 4 Working Length, 135 mm (Men's)



Fig. 1



Fig. 2



Fig. 3



Fig. 4

01-162 A Fig. 1 Working Length, 70 mm (Children's)  
 01-162 B Fig. 2 Working Length, 90 mm (Adolescent's)  
 01-162 C Fig. 3 Working Length, 110 mm (Women's)  
 01-162 D Fig. 4 Working Length, 135 mm (Men's)



**01-164**  
 Fiber Optic  
 Battery Handle  
 30mm diam.



**01-165**  
 Fiber Optic  
 Battery Handle  
 18mm diam.



**01-166**  
 Replacement Lamp  
 ( Krypton ) 2.5 V



**01-167**  
 Replacement Lamp  
 ( Halogen ) 2.5 V

Examination & Measuring Instruments



**01-168**  
Caliper Of Aluminium  
Graduated in mm & inches  
up to 180mm  
Measuring Range up to 139mm



**01-169**  
VERNIER  
Universal Caliper Of Steel  
Graduated in mm & inches  
up to 180mm  
Measuring Range up to 120mm  
with Vernier in 1/10mm & 1/16"



**01-170**  
CARROLL  
Size: 145 mm  
Finger Goniometer



**01-171**  
TOWNLEY  
Graduated in  
mm & inches  
Size: 115 mm



**01-172**  
COLLIN  
Druck Pressure 72 kg  
Size: 125 mm



**01-173**  
BERTILLON  
Caliper For Measuring The Head  
Size: 320 mm



**01-174**  
CASTROVIEJO  
Caliper  
Size: 75mm



**01-175**  
MOLTGEN  
Goniometer



**01-176**  
Size: 150 mm



**01-177**  
Size: 500 mm

Dissecting Knives



02-101 - 110  
Fig. 1 - 10



02-101  
Fig. 1  
30 mm



02-102  
Fig. 2  
36 mm



02-103  
Fig. 3  
40 mm



02-104  
Fig. 4  
45 mm



02-105  
Fig. 5  
50 mm



02-106  
Fig. 6  
27 mm



02-107  
Fig. 7  
35 mm



02-108  
Fig. 8  
40 mm



02-109  
Fig. 9  
47 mm



02-110  
Fig. 10  
50 mm

Amputating Knives, Cartilage Knives  
and Autopsy Knives



**LISTON**

**02-111**  
Size: 130 mm  
**02-112**  
Size: 160 mm  
**02-113**  
Size: 190 mm  
**02-114**  
Size: 200 mm

Blade length  
Amputating Knives

**02-115**

**CATLIN**  
Size: 160 mm  
Blade length  
Amputating  
Knives

**02-116**

**LANGENBECK**  
Size: 120 mm  
Blade length  
Flap Knives

**02-117**

Size: 110 mm  
Blade length  
Interosseous  
Knives

**02-118**

Size: 55 mm  
Blade length  
with raspatory,  
Wooden handle

**02-119**

Size: 70 mm  
Blade length  
Wooden handle

**02-120**

Size: 80 mm  
Blade length  
Metal handle

**02-121**

Size: 195 mm  
Blade length  
Metal handle

Cone Knives, Myomatome, Trigeminal and Tonsil Knives

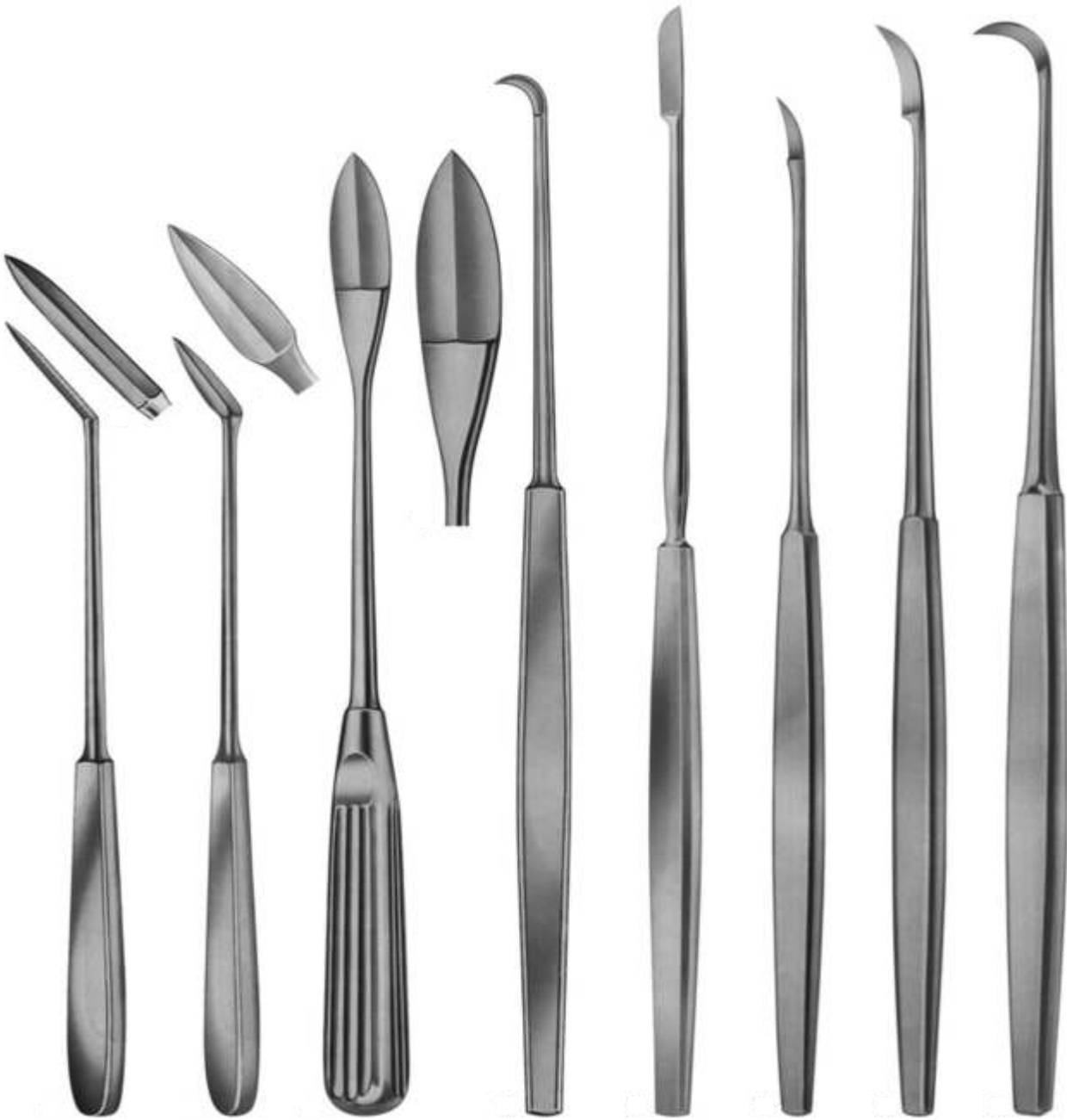

**02-122**  
**AYRE**  
Size: 235 mm  
Cone Knife

**02-123**  
Size: 230 mm  
Cone Knife

**02-124**  
**SEGOND**  
Size: 270 mm  
Myomatome

**02-125**  
**OLIVECRONA**  
Size: 205 mm  
Trigeminal  
Knife

**02-126**  
Size: 230 mm  
Trigeminal  
Knife

**02-127**  
**FOWLER**  
Size: 200 mm  
Tonsil Knife

**02-128**  
**ABRAHAM**  
Size: 215 mm  
Tonsil Knife

**02-129**  
**BRUNINGS**  
Size: 215 mm  
Tonsil Knife

Scalpel Handles

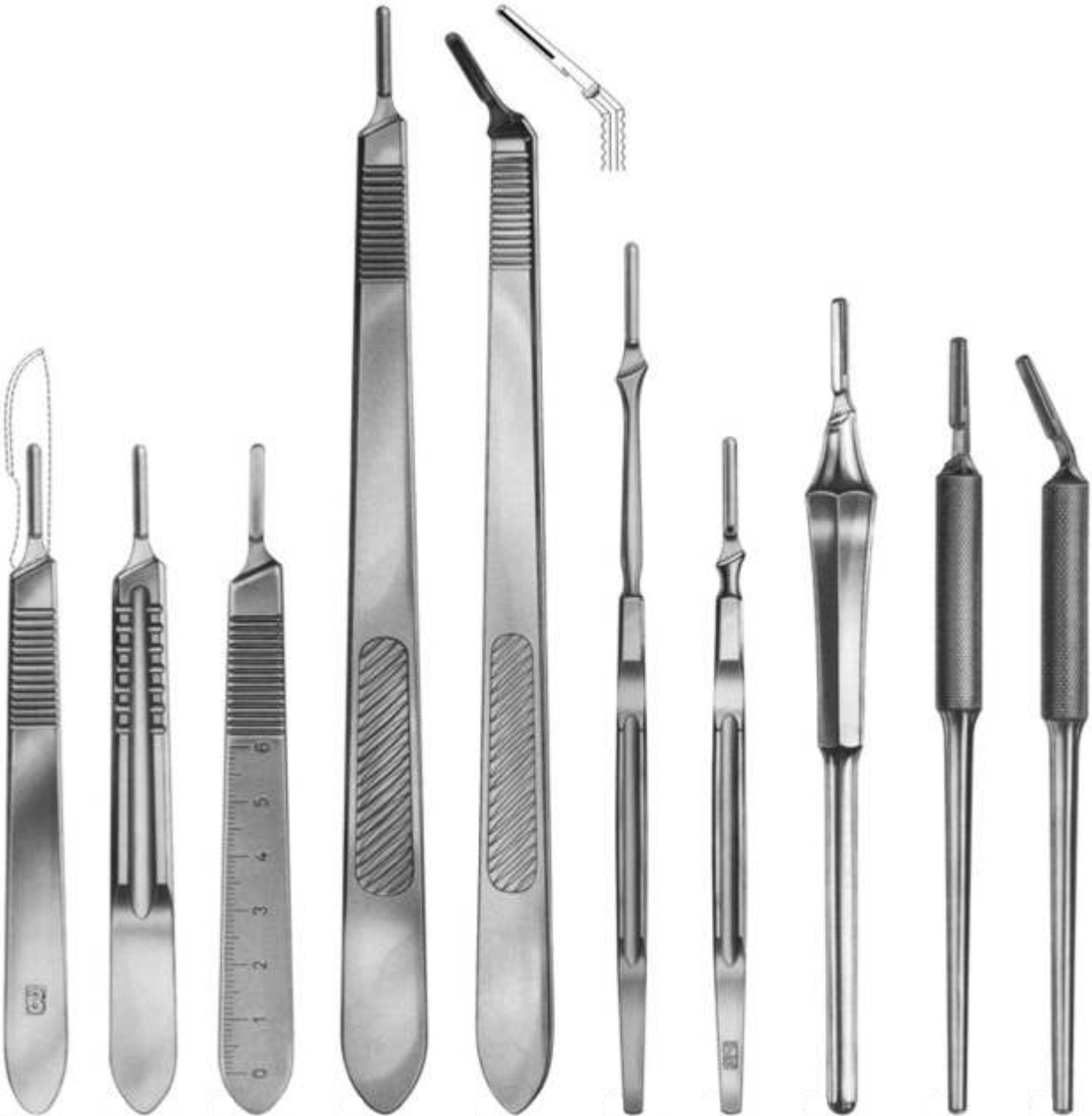

**02-130**  
STANDARD  
No. 3  
Solid  
12 cm

**02-131**  
No. 3  
Solid  
12 cm

**02-132**  
No. 3  
Solid  
12 cm

**02-133**  
No. 3 L  
Straight  
Solid  
21.5 cm

**02-134**  
No. 3 L  
Angled  
Solid  
21 cm

**02-135**  
No. 7  
Solid  
16 cm

**02-136**  
No. 7 K  
Solid  
12.5 cm

**02-137**  
Hollow-Round  
15.5 cm

**02-138**  
No. 3  
Straight  
Solid,  
Round  
14.5 cm

**02-139**  
No. 3  
Angled  
Solid,  
Round  
14 cm

**Micro Scissors (Spring Type) with flat Handles**



**03-101 - 103**  
**VANNAS**  
Size: 85 mm



**03-104 - 105**  
**CASTROVIEJO**  
Size: 95 mm



**03-106**  
**NOYES**  
Size: 125 mm



**03-107 - 108**  
**WECKER**  
Eye scissor  
Size: 110 mm



**03-109**  
**CASTROVIEJO**  
Eye scissor  
Size: 115 mm



**03-110 - 111**  
**CASTROVIEJO**  
Eye scissor  
Size: 110 mm

**Micro Scissors (Spring Type) with flat Handles**

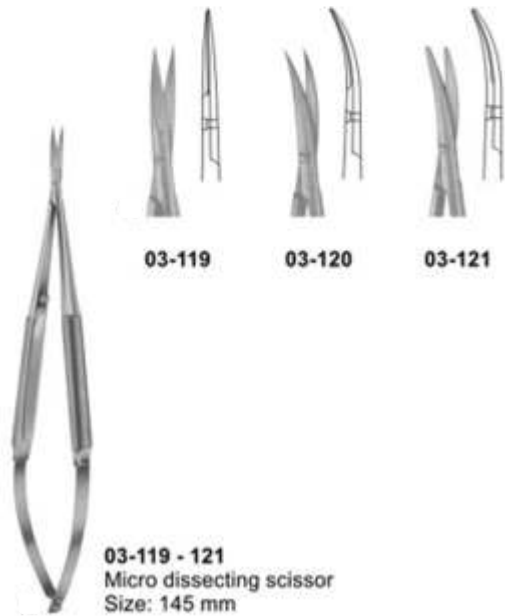
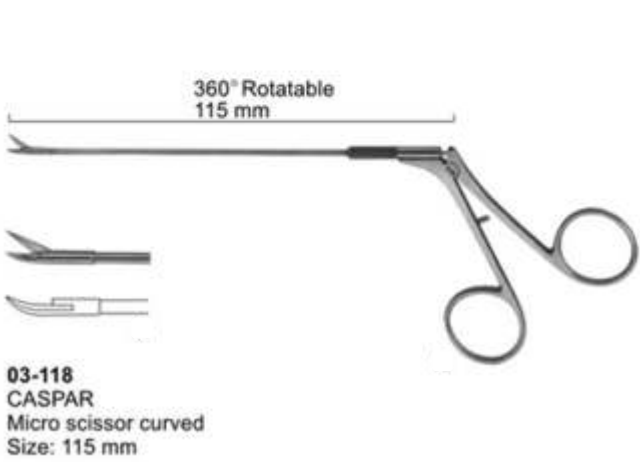
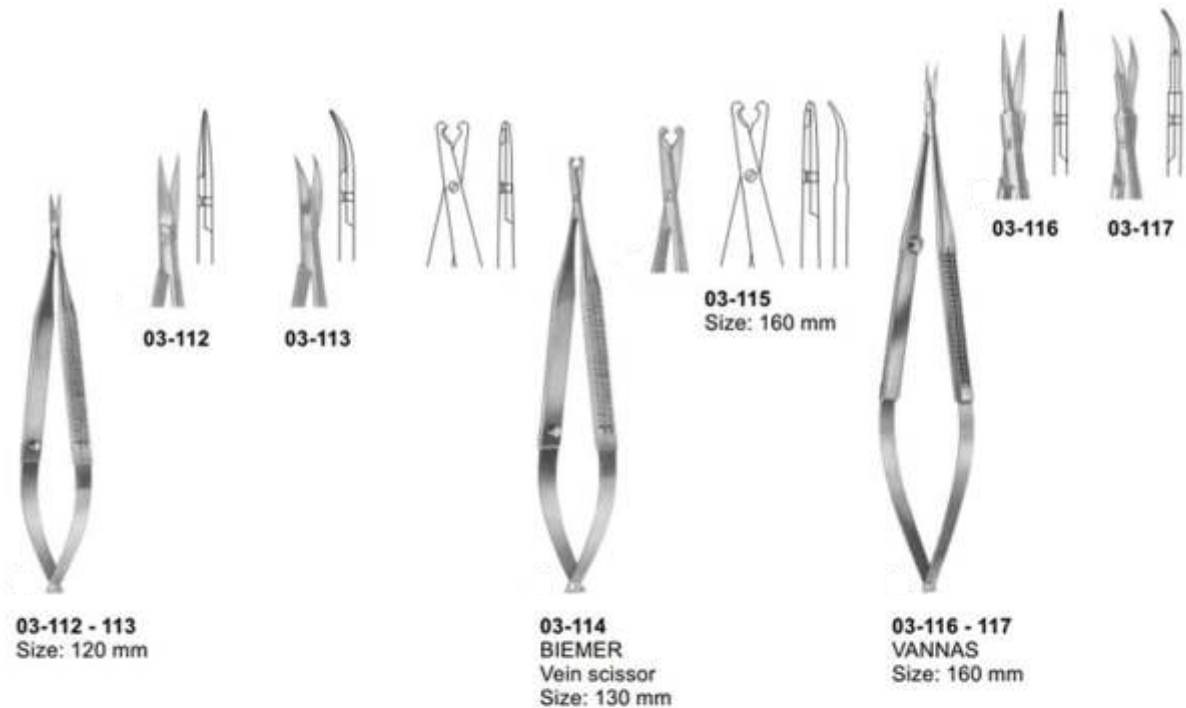

Micro Scissors (Spring Type) bayonet-Shapes



**03-122**  
YASARGIL  
Size: 245 mm



**03-123**  
45



**03-124**  
45



**03-123 - 124**  
laterally angled  
Size: 200 mm



**125**



**03-125**  
laterally angled  
Size: 190 mm



**03-126**



**03-127**



**03-126 - 127**  
YASARGIL  
Size: 225 mm

Delicate Scissors



03-128

03-129

03-128 - 129  
Size: 90 mm



03-130

03-131

03-130 - 131  
Size: 95 mm



03-132

03-133

03-132 - 133  
Size: 105 mm



03-134

03-135

03-134 - 135  
Size: 120 mm



03-136

03-137

03-136 - 137  
Size: 115 mm

Delicate Scissors



03-138 - 140  
Size: 120 mm



03-138



03-139



03-140



03-141 - 144  
Size: 130 mm

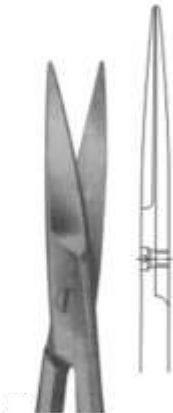

03-141



03-142

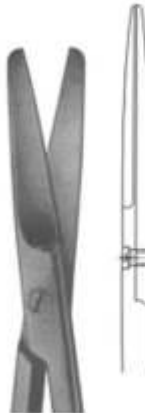

03-143



03-144

## Surgical Scissors



**03-145 - 153 (Standard types)**  
 03-145 (105 mm)  
 03-146 (115 mm)  
 03-147 (130 mm)  
 03-148 (145 mm)  
 03-149 (150 mm)  
 03-150 (165 mm)  
 03-151 (175 mm)  
 03-152 (185 mm)  
 03-153 (200 mm)

**03-145**  
 Size: 105 mm

**03-153**  
 Size: 200 mm



**03-154 - 160 (Standard types)**  
 03-154 (115 mm)  
 03-155 (130 mm)  
 03-156 (145 mm)  
 03-157 (150 mm)  
 03-158 (165 mm)  
 03-159 (175 mm)  
 03-160 (185 mm)

**03-154**  
 Size: 115 mm

**03-160**  
 Size: 185 mm

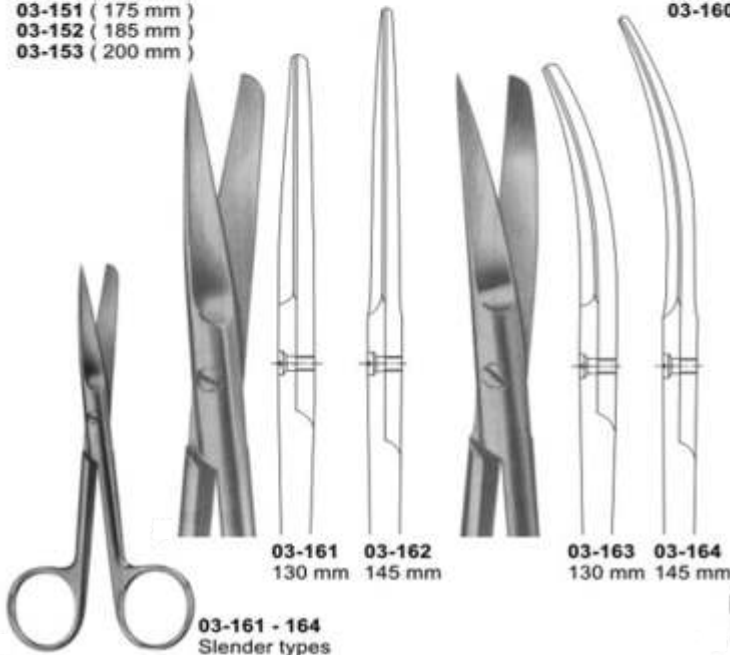

**03-161 - 164**  
 Slender types

**03-161**  
 130 mm

**03-162**  
 145 mm

**03-163**  
 130 mm

**03-164**  
 145 mm



**03-165 - 166**  
 for wound edges. 1 blade serrated

**03-165**  
 130 mm

**03-166**  
 130 mm

Surgical Scissors



03-167 - 169  
DEAVER  
with flat lock

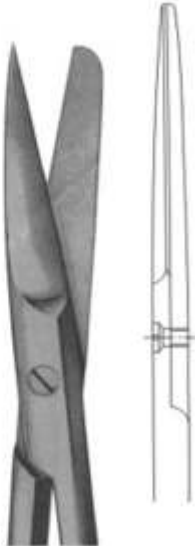

03-167  
Size: 145 mm

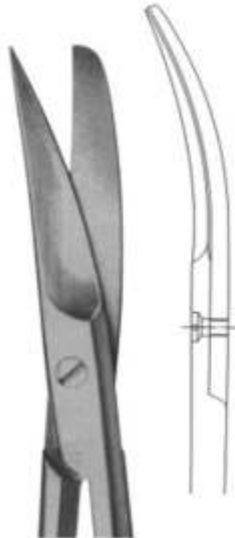

03-168  
Size: 145 mm

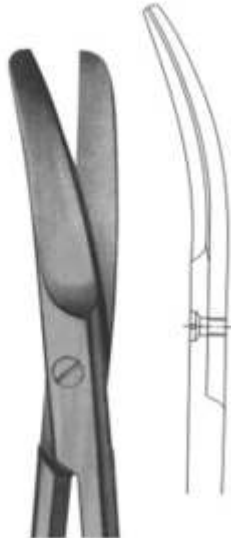

03-169  
Size: 145 mm



03-170 - 172  
Incision scissors



03-170  
Size: 130 mm



03-171  
Size: 145 mm



03-172  
Size: 165 mm



03-173  
SYSTRUNK  
Nail splitting scissors



03-173  
Size: 130 mm

Dissecting Scissors



**03-174**  
Size: 125 mm



**03-175**  
Size: 150 mm

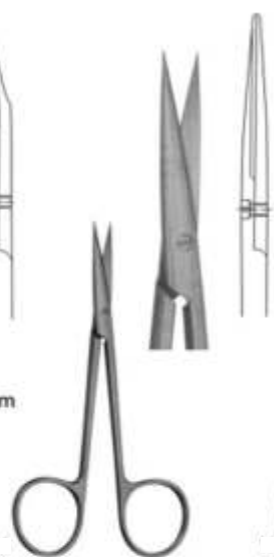

**03-176**  
KILNER  
Fine dissecting scissors  
Size: 115 mm

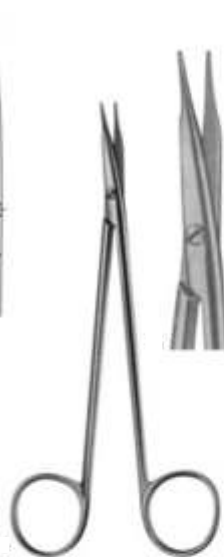

**03-177**  
JAMESON  
Dissecting scissors  
Size: 150 mm

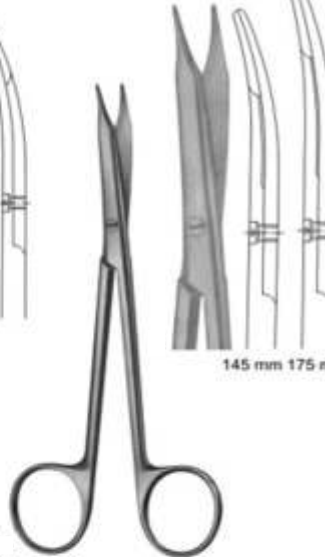

**03-178**  
REYNOLDS  
Dissecting scissors  
Size: 145 - 175 mm

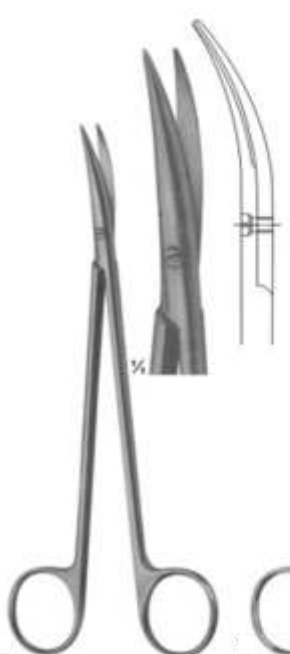

**03-179**  
DE BAKEY  
Arteriotomy scissors  
Size: 175 mm

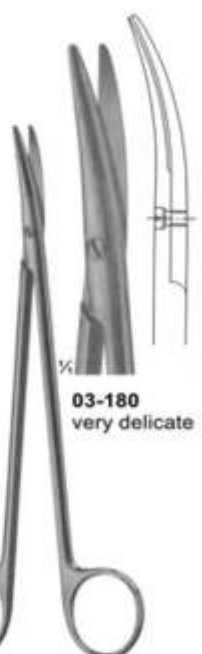

**03-180**  
very delicate



**03-181**  
delicate



**03-182**  
very delicate



**03-183**  
delicate

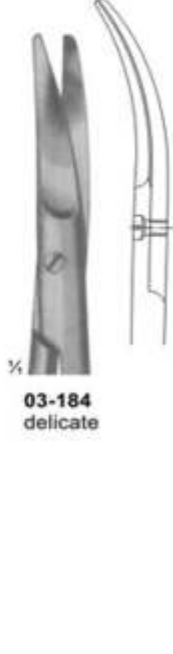

**03-184**  
delicate

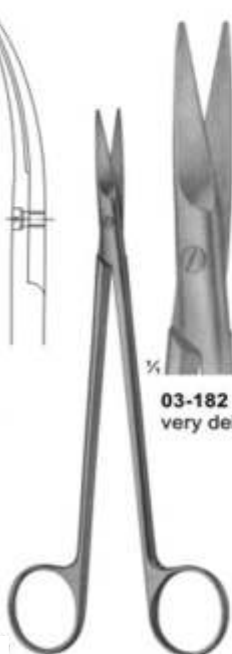

**03-182 - 184**  
TOENNIS  
Dissecting scissors  
Size: 180 mm

Dissecting Scissors

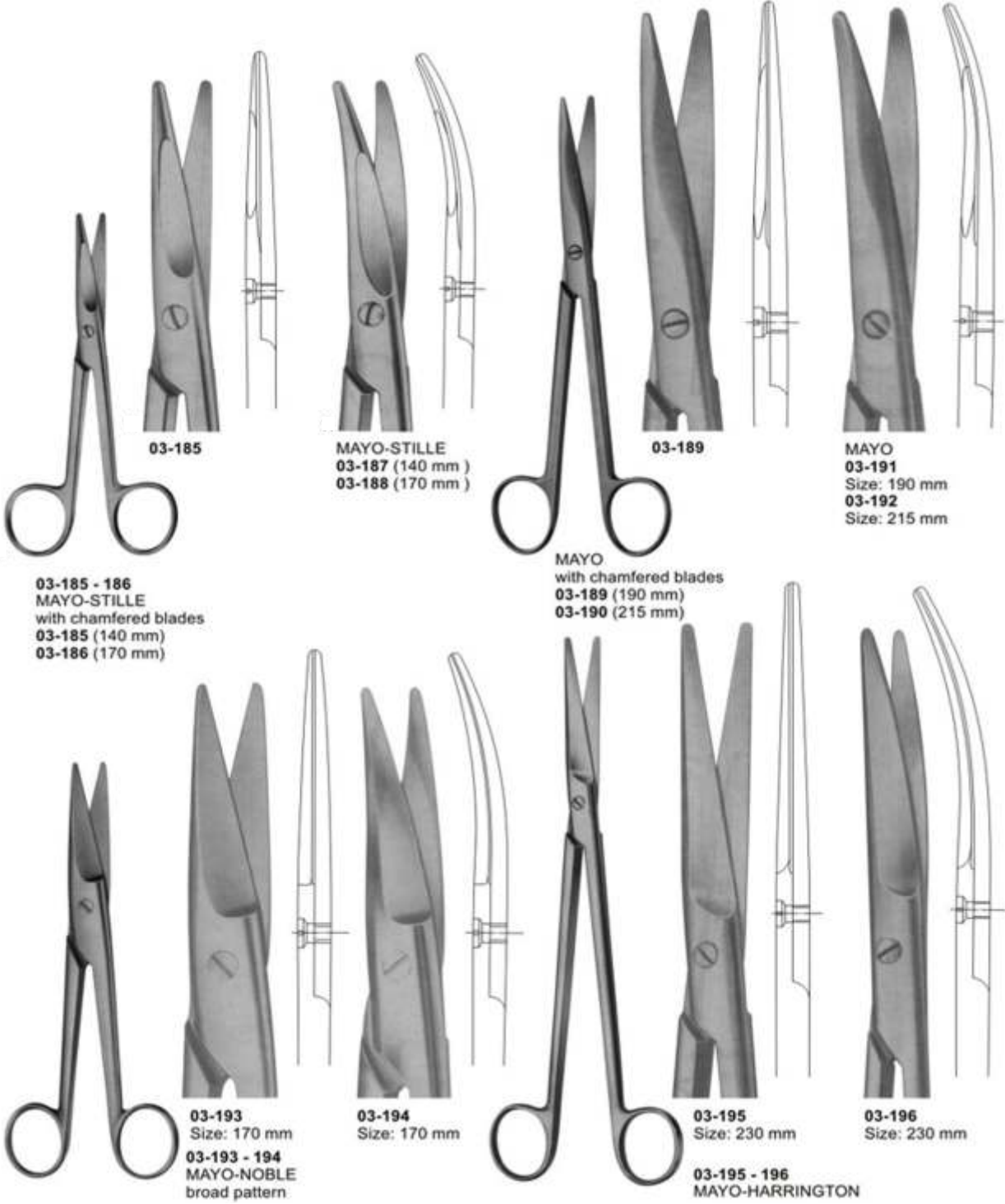

Scissors For Cardiovascular and Neuro-Surgery



03-197  
OLIVECRONA  
Dura scissors

03-198  
STRULLY  
pointed  
Size: 220 mm

03-199  
STRULLY  
probe pointed  
Size: 220 mm

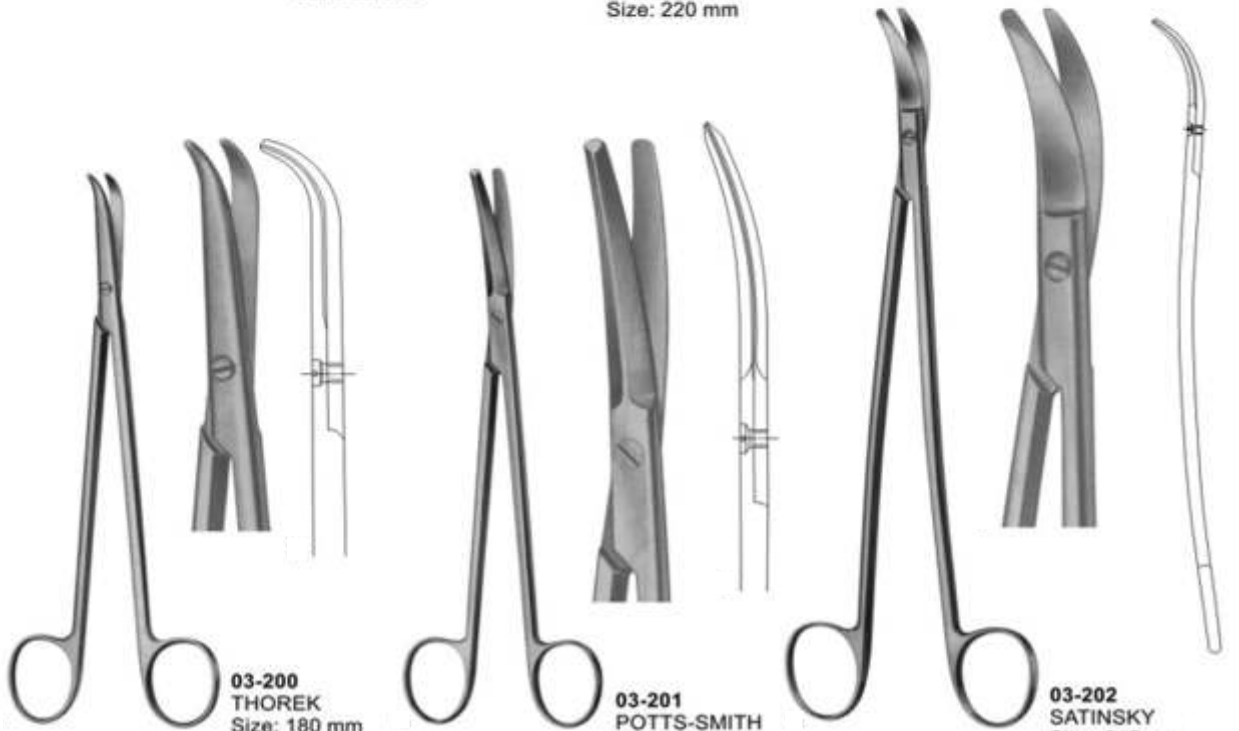

03-200  
THOREK  
Size: 180 mm

03-201  
POTTS-SMITH  
Size: 190 mm

03-202  
SATINSKY  
Size: 245 mm

Delicate, Nasal and Tonsil Scissors

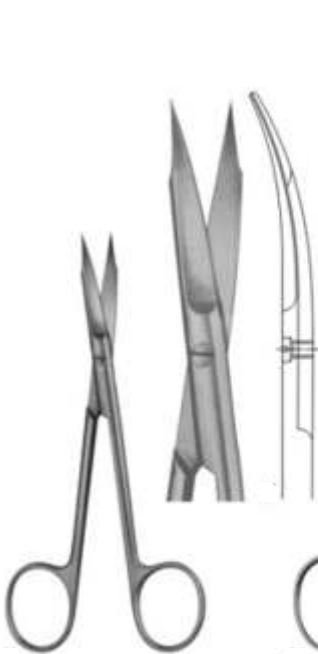

**03-203**  
1 finely toothed blade  
Size: 130 mm

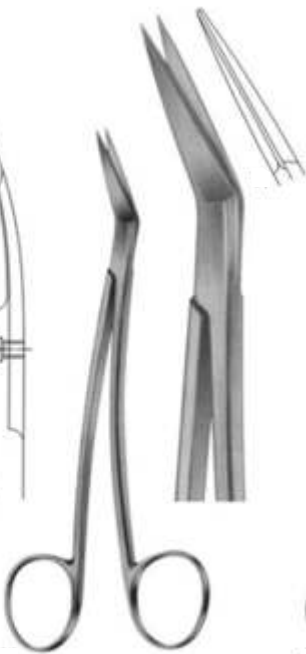

**03-204**  
LOCKLIN  
curved sideways,  
1 toothed blade  
Size: 155 mm



**03-205**  
FOMON  
blades serrated  
Size: 145 mm

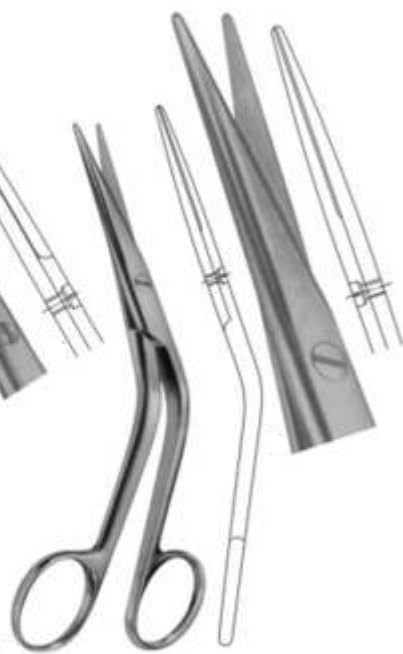

**03-206**  
COTTLE  
Size: 165 mm



**03-207**  
HEYMANN-KNIGHT  
Size: 175 mm



**03-208**  
DEAN  
blades serrated  
Size: 170 mm

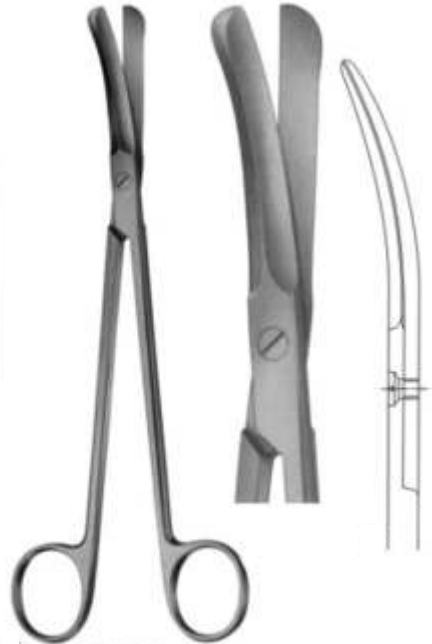

**03-209**  
GOOD  
Size: 195 mm

Bone Shears



03-210  
KILLIAN  
Size: 200 mm



03-211 - 03-212



03-211  
195 mm



03-212  
225 mm



Scissors for deep operations and for Gynaecology

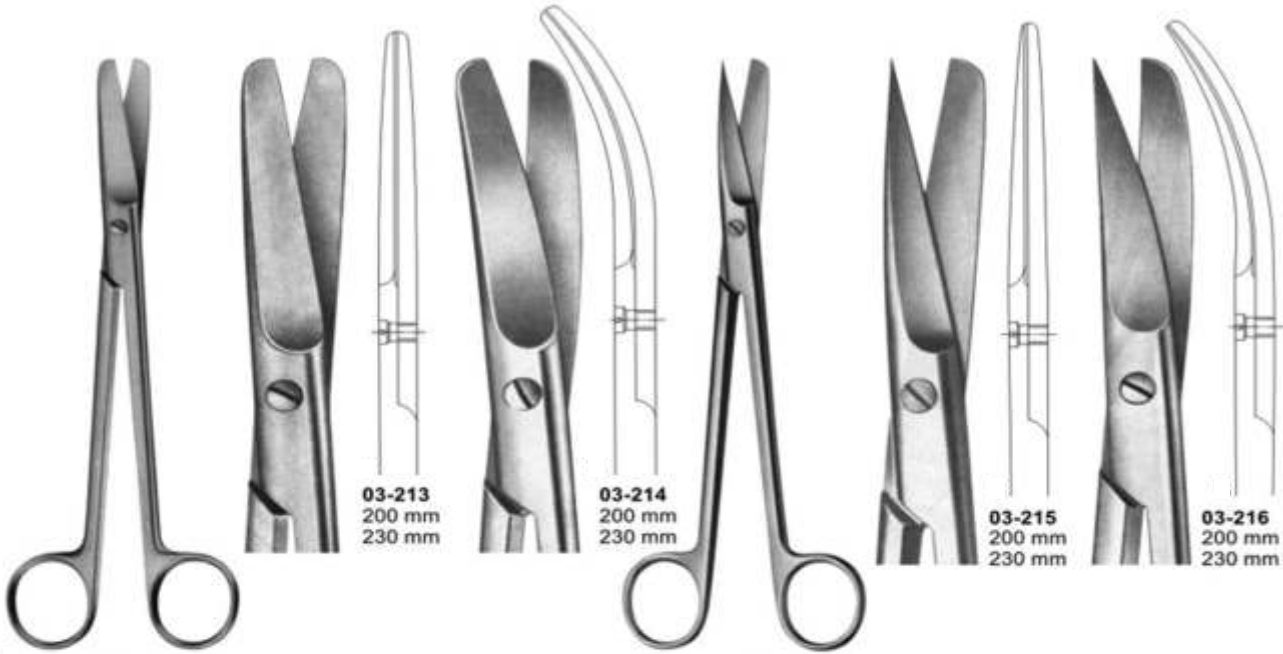

03-213 - 03-214  
SIMS

03-215 - 03-216  
SIMS



Size: 200 mm

Size: 210 mm

03-219 145 mm  
03-220 200 mm  
03-221 230 mm

03-217  
SIMS

03-218  
SIMS

03-219 - 03-221  
WERTHEIM

Scissor for Obstetrics



**03-222**  
**SCHUMACHER**  
Umbilical cord scissors  
Size: 155 mm



**03-223**  
Umbilical cord scissors  
Size: 105 mm

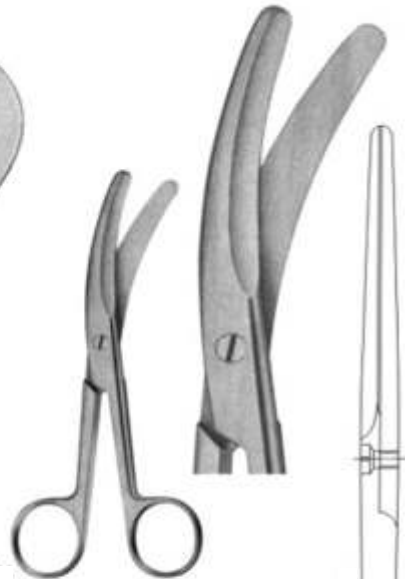

**03-224**  
Umbilical cord scissors

135 mm



**03-225 - 03-226**  
**BRAUN-STADLER**  
Episiotomy scissors



**03-225**  
145 mm



**03-226**  
200 mm



**03-227**  
Episiotomy scissors  
240 mm



Wire and Plate Scissors



03-228 - 03-232  
BEEBE  
Size: 110 mm



03-228

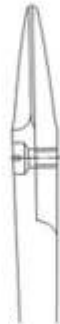

03-229



03-230  
broad blades



03-231  
1 blade serrated



03-232  
NAUJOKS  
strongly curved



03-233  
1 blade serrated  
Size: 120 mm



03-234  
STRACK  
Size: 100 mm



03-235  
HARVEY  
blades serrated  
Size: 125 mm



Bandage and Cloth Scissors



**03-236**  
Universal bandage and cloth scissors,  
with toothed edges  
180 mm

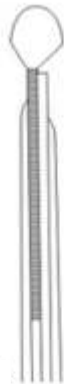

**03-237**  
LISTER  
Universal bandage and cloth scissors,  
with toothed edges  
Size: 145 mm

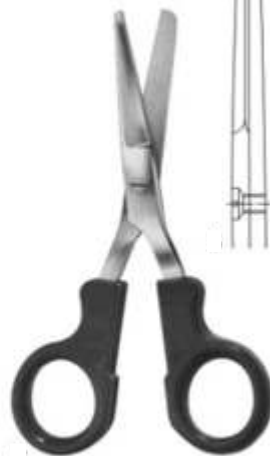

**03-238**  
LISTER  
Nurse's scissors  
Size: 145 mm



**03-239**  
115 mm



**03-240**  
140 mm



**03-241**  
180 mm



**03-242**  
200 mm



**03-239 - 03-242**  
LISTER



**03-243**  
155 mm



**03-244**  
180 mm



**03-243 - 03-244**  
LISTER

Bandage, Cloth, and Plaster Scissors



03-245  
CLOTH SCISSORS  
205 mm



03-246  
BRAUN-STADLER  
225 mm



03-247  
SEUTIN  
230 mm

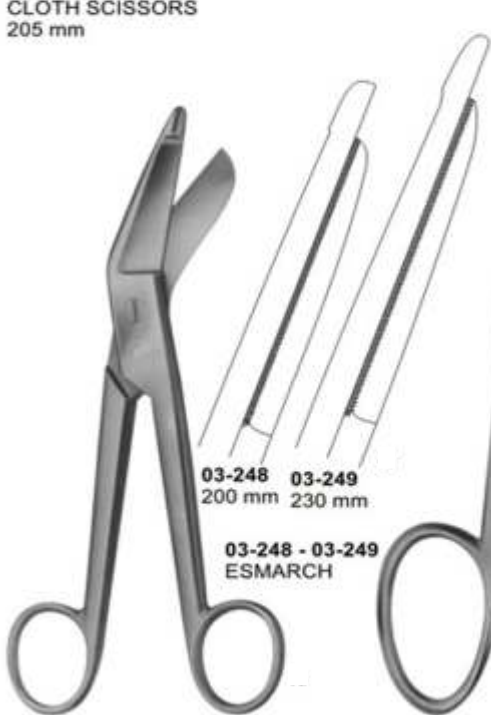

03-248 03-249  
200 mm 230 mm

03-248 - 03-249  
ESMARCH

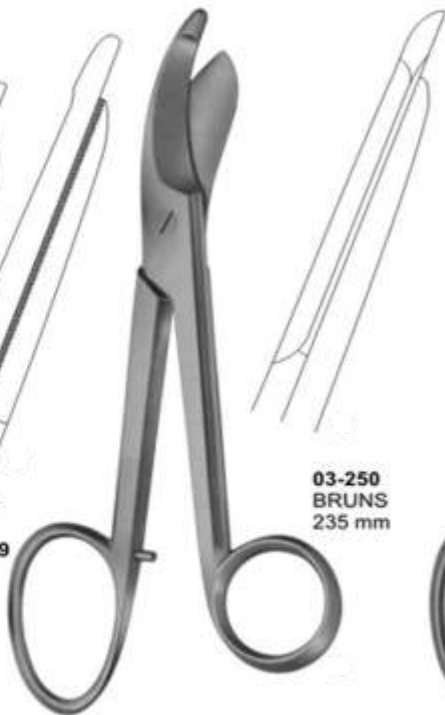

03-250  
BRUNS  
235 mm



03-251  
Bandage Scissors  
235 mm

Forceps for grasping tissue, Tumors etc.

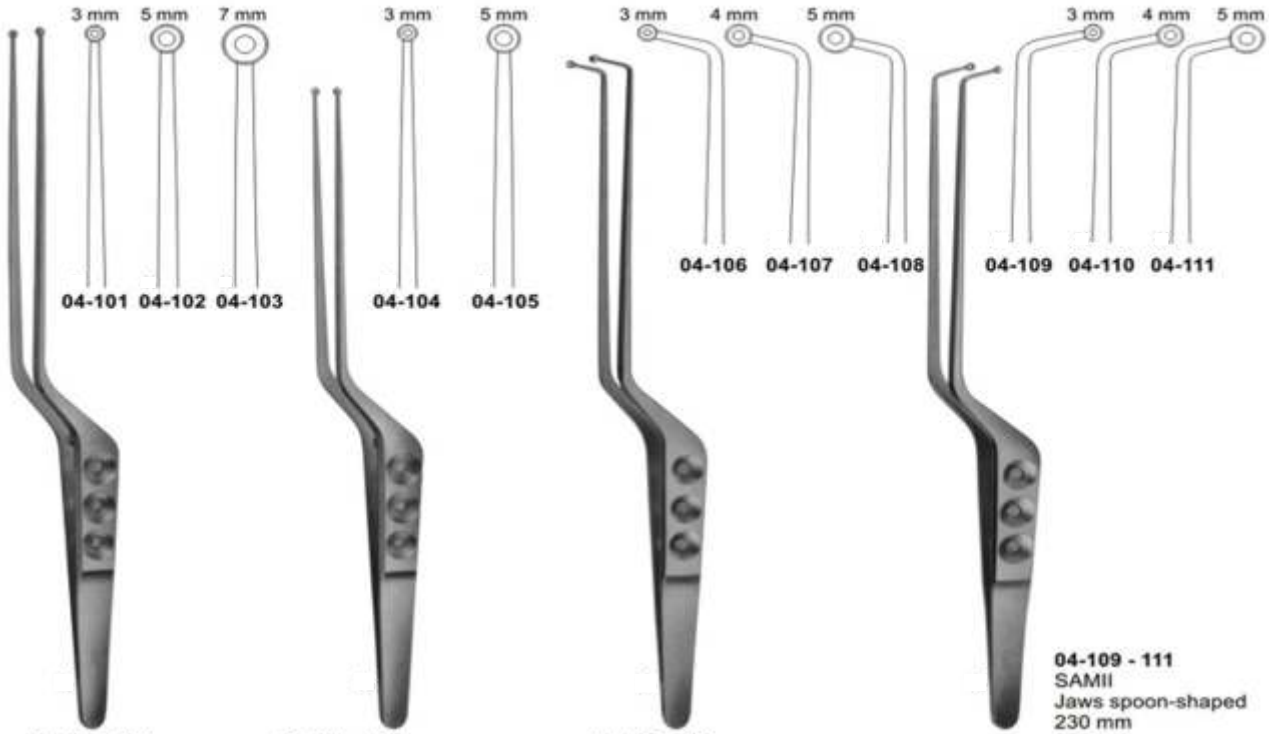

**04-101 - 103**  
YASARGIL-SAMII  
Jaws spoon-shaped  
240 mm

**04-104 - 105**  
YASARGIL  
Jaws spoon-shaped  
220 mm

**04-106 - 108**  
SAMII  
Jaws spoon-shaped  
230 mm

**04-109 - 111**  
SAMII  
Jaws spoon-shaped  
230 mm

**04-112**  
HUNT  
Tumor-and  
vessel forceps  
200 mm

**04-113**  
HUNT  
Tumor-and  
vessel forceps  
200 mm

**04-114**  
YASARGIL  
Tumor-and  
vessel forceps  
200 mm

Delicate Dissecting, Microscopic,  
Sterilizing Forceps



04-115  
THORPE  
Corneal forceps  
120 mm



04-116  
MICRO-ADSON  
120 mm



04-117  
ADSON  
120 mm



04-118  
MICRO-ADSON  
150 mm



04-119 - 121  
100 mm



04-119 04-120 04-121



04-122  
BONACCOLTO  
110 mm



04-123  
115 mm

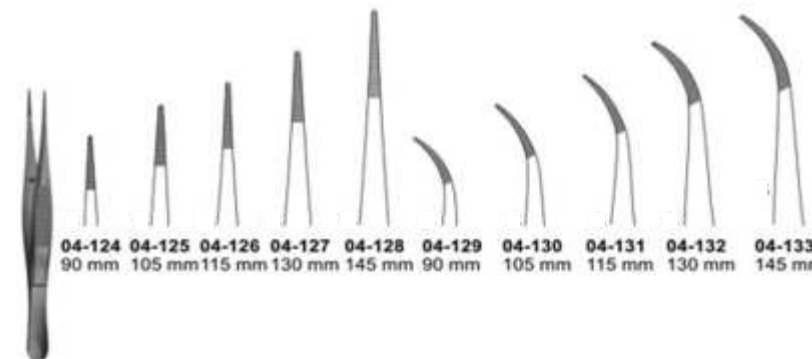

04-124 - 133

04-124 90 mm 04-125 105 mm 04-126 115 mm 04-127 130 mm 04-128 145 mm 04-129 90 mm 04-130 105 mm 04-131 115 mm 04-132 130 mm 04-133 145 mm



04-134  
100 mm



04-135  
100 mm



04-136  
100 mm



04-137  
KUHNE  
Cover glass forceps, 105 mm



04-138  
160 mm

Delicate Dissecting Forceps

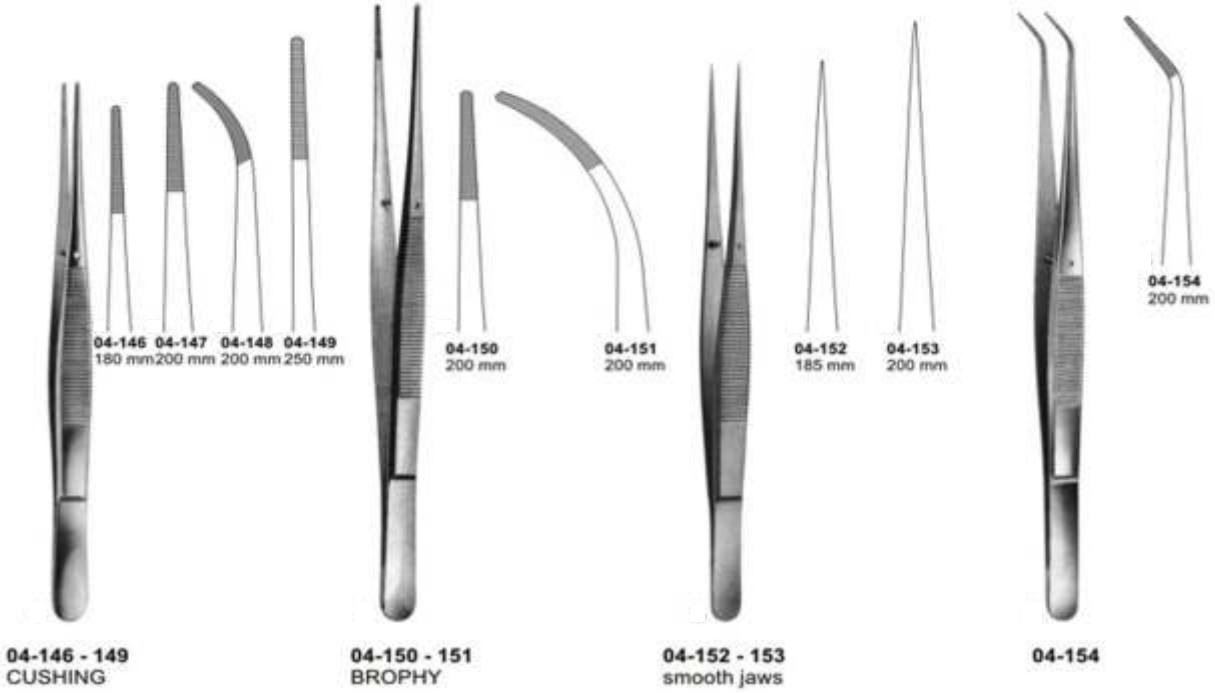
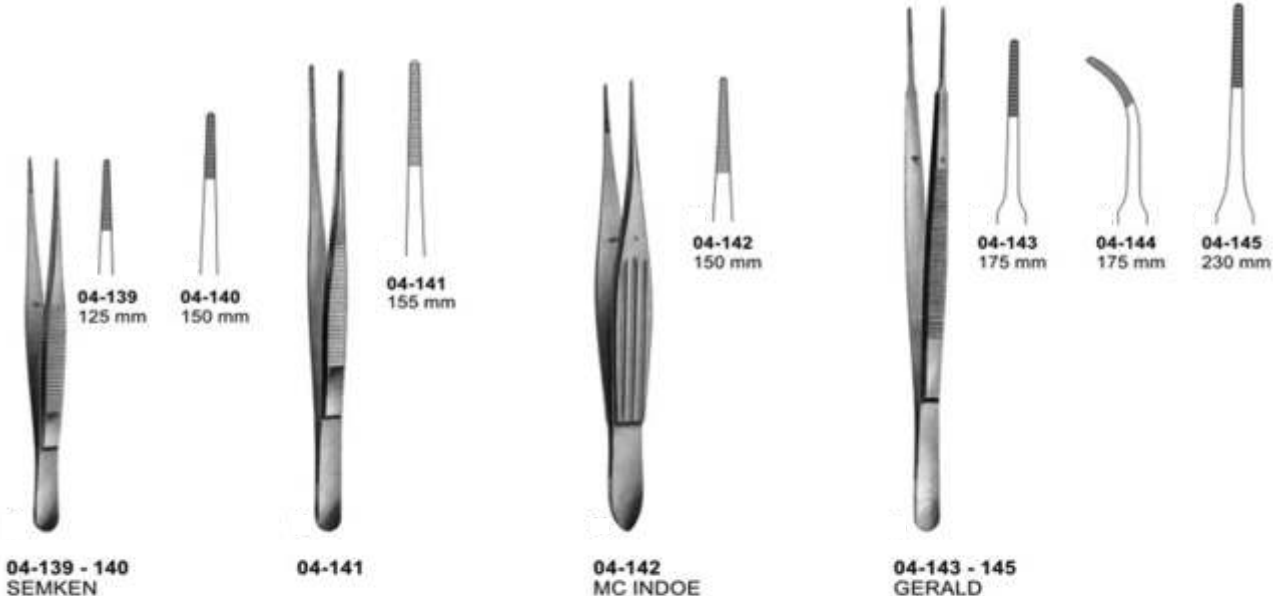

Dissecting Forceps

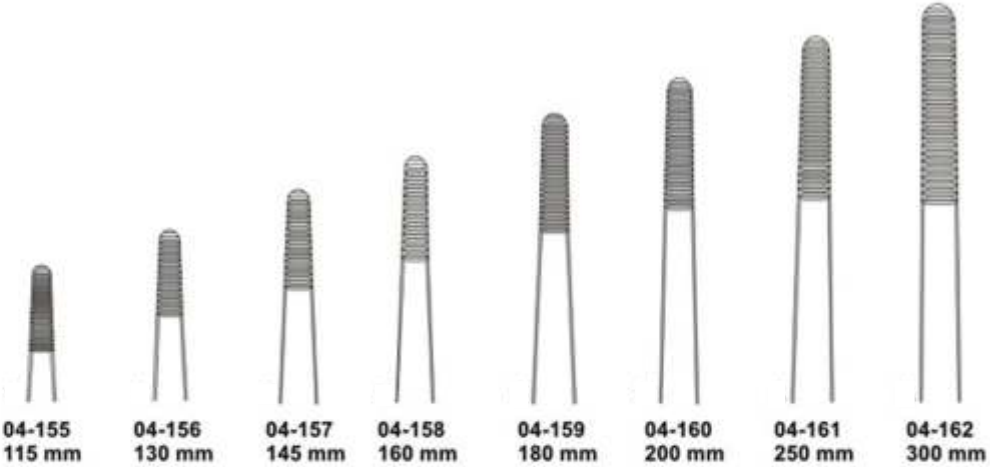

04-155 115 mm    04-156 130 mm    04-157 145 mm    04-158 160 mm    04-159 180 mm    04-160 200 mm    04-161 250 mm    04-162 300 mm

04-155 - 04-162  
STANDARD



04-163 115 mm    04-164 130 mm    04-165 145 mm    04-166 160 mm    04-167 305 mm

04-163 - 04-167  
MEDIUM



04-168 130 mm    04-169 145 mm

04-168 - 04-169  
MEDIUM

Forceps

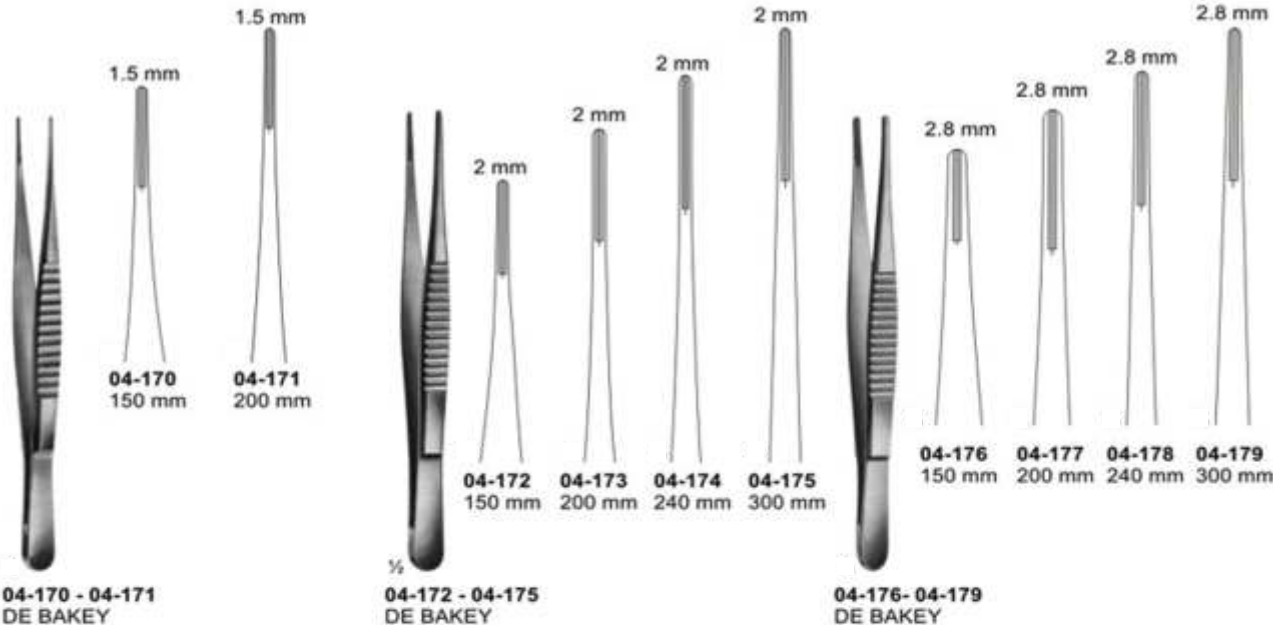

Delicate Tissue Forceps



04-185  
BISHOP-HARMON  
85 mm

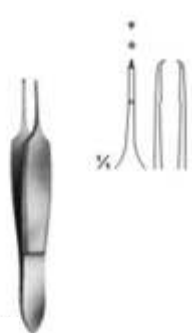

04-186  
ST. MARTIN  
80 mm



04-187  
CASTROVIEJO  
teeth 0.9 mm  
100 mm



04-188  
CASTROVIEJO  
teeth 0.5 mm  
100 mm



04-189  
ELSCHING  
110 mm



04-190  
GILL  
75 mm

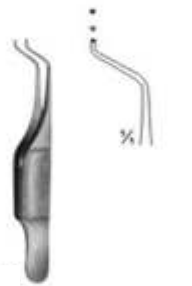

04-191  
GILL - HESS  
75 mm



04-192  
HESS  
70 mm



04-193  
ARRUGA  
100 mm



04-194  
SEMKEN



04-195  
MICRO-ADSON  
120 mm



04-196  
ADSON  
120 mm



04-197  
ADSON  
120 mm



04-198  
ADSON  
120 mm



04-199  
ADSON  
150 mm

Tissue Forceps

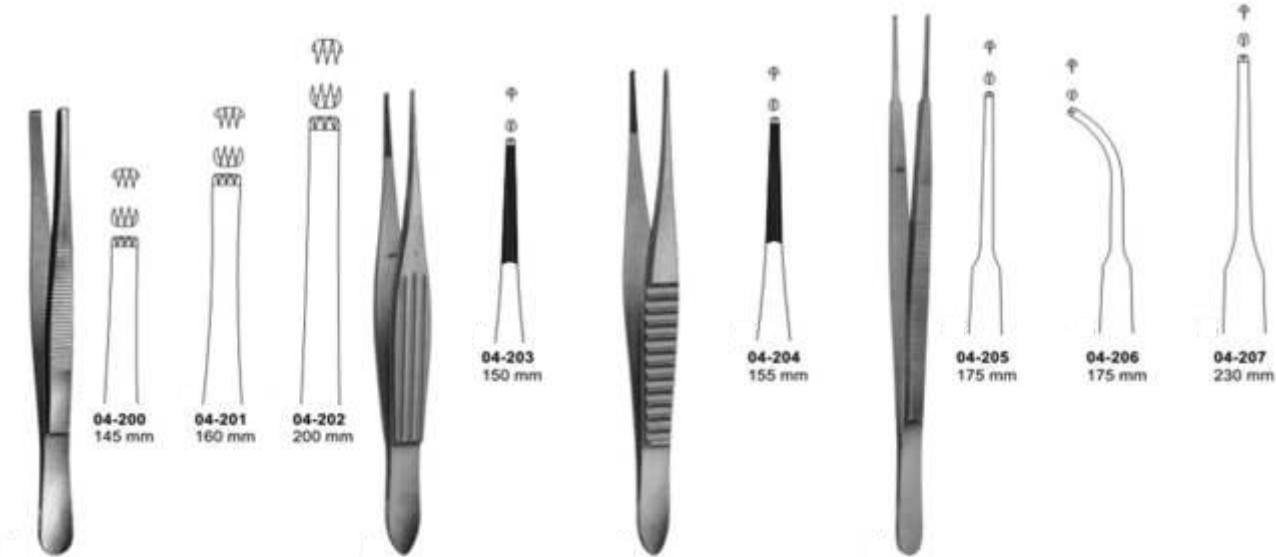

04-200 - 04-203  
3x4 teeth

04-203  
MC INDOE

04-204  
GILLIES

04-205 - 04-207  
GERALD



04-208 - 04-211  
WAUGH

04-212  
BROPHY

Tissue Forceps



04-213  
ADSON - BROWN  
Non-traumatic  
120 mm



04-214  
BROWN  
120 mm



04-215  
GRAEFE  
110 mm



04-216  
GRAEFE  
With Catch  
110 mm

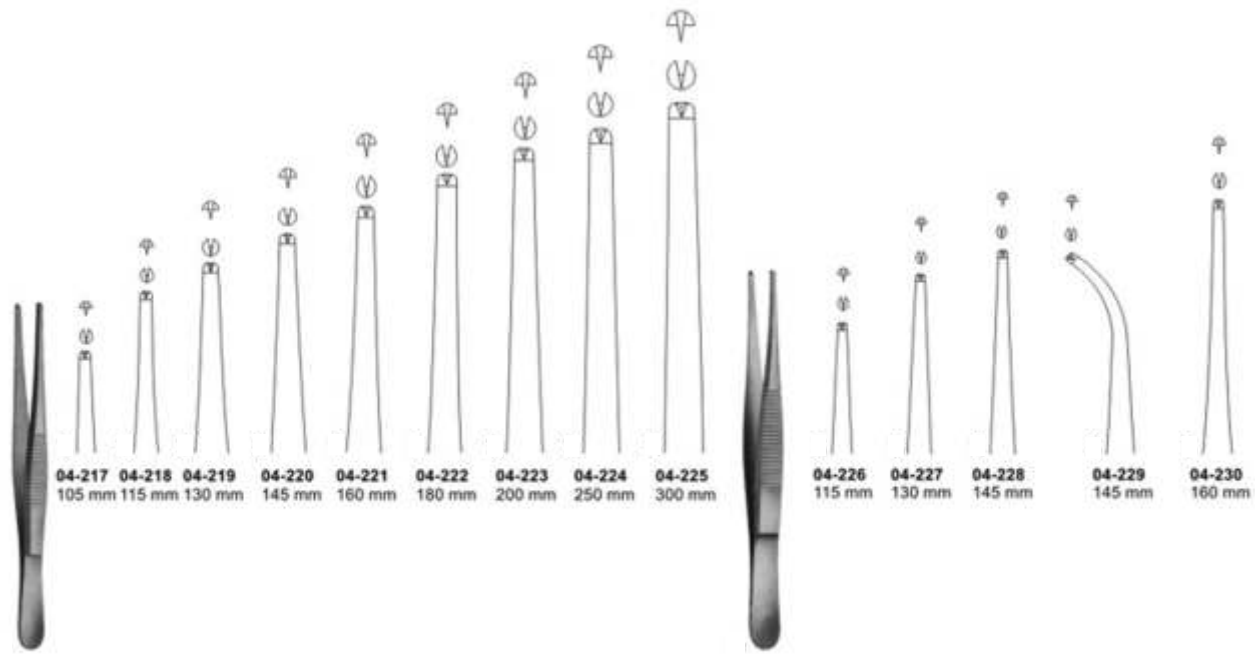

04-217 - 04-225  
STANDARD

04-226 - 04-230  
GRAEFE  
110 mm

Forceps, Bayonet - Shaped



04-231  
LUCAE  
140 mm



04-232  
LUCAE  
1x2 teeth  
140 mm



04-233  
COTTLE  
Forceps with  
jaws toothed  
and serrated  
140 mm



04-234  
JANSEN  
160 mm



04-235  
GRUENWALD  
200 mm



04-236  
1x2 teeth  
200 mm



04-237  
TROELTSCH  
100 mm



04-238  
TROELTSCH  
115 mm



04-239  
TROELTSCH  
1X2 teeth  
115 mm



04-240  
WILDE  
115 mm



04-241  
TROELTSCH  
Cross action  
120 mm



04-242  
TROELTSCH  
140 mm

**Tissue Forceps, Lung Dissecting Forceps**

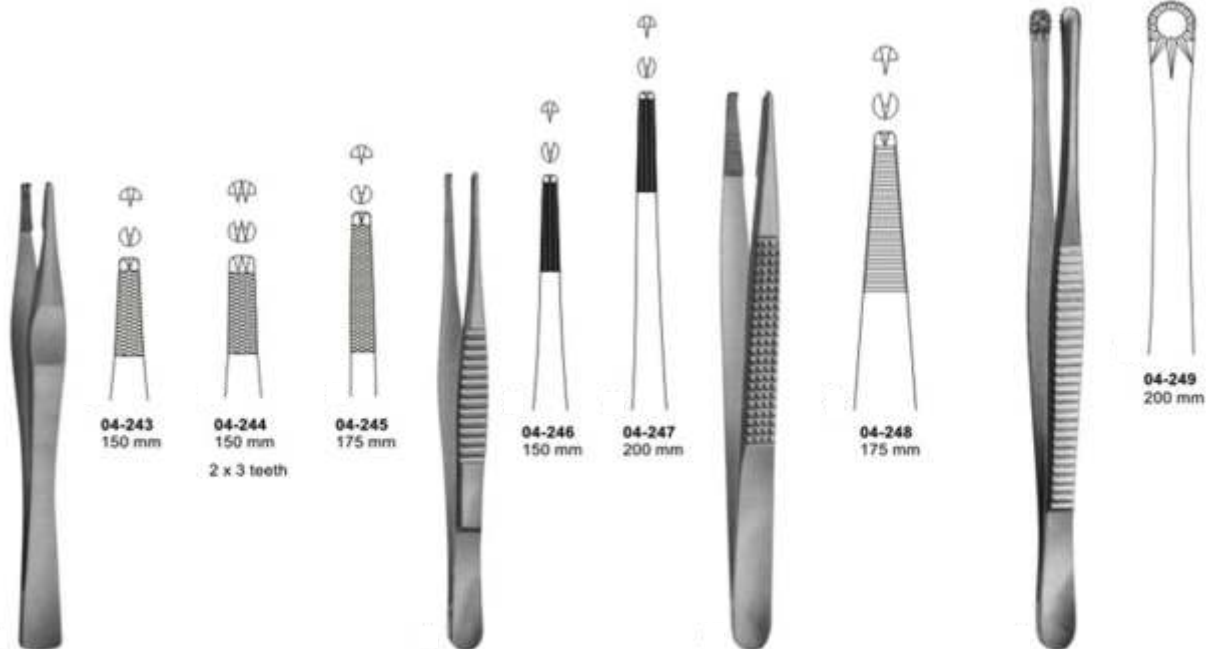

**04-243 - 04-245**  
**LANE**

**04-243**  
150 mm

**04-244**  
150 mm  
2 x 3 teeth

**04-245**  
175 mm

**04-246 - 04-247**  
**STRASSBURGER  
MODELL**

**04-246**  
150 mm

**04-247**  
200 mm

**04-248**  
**BONNEY**

**04-248**  
175 mm

**04-249**  
**RUSS.MODELL**  
200 mm



**04-250**  
**TUTTLE**  
Lung dissecting  
forceps  
230 mm

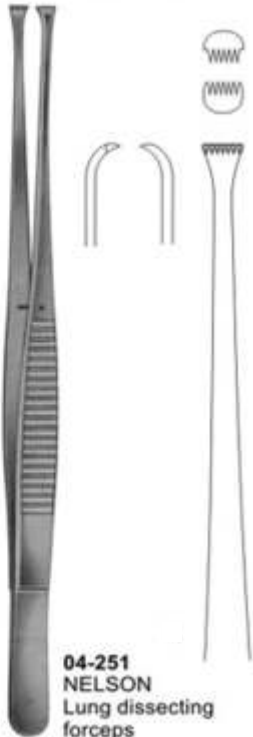

**04-251**  
**NELSON**  
Lung dissecting  
forceps  
230 mm



**04-252**  
**DUVAL**  
Intestinal forceps  
140 mm



**04-253**  
**DENIS-BROWNE**  
Intestinal forceps  
190 mm

Splinter and Cilia Forceps

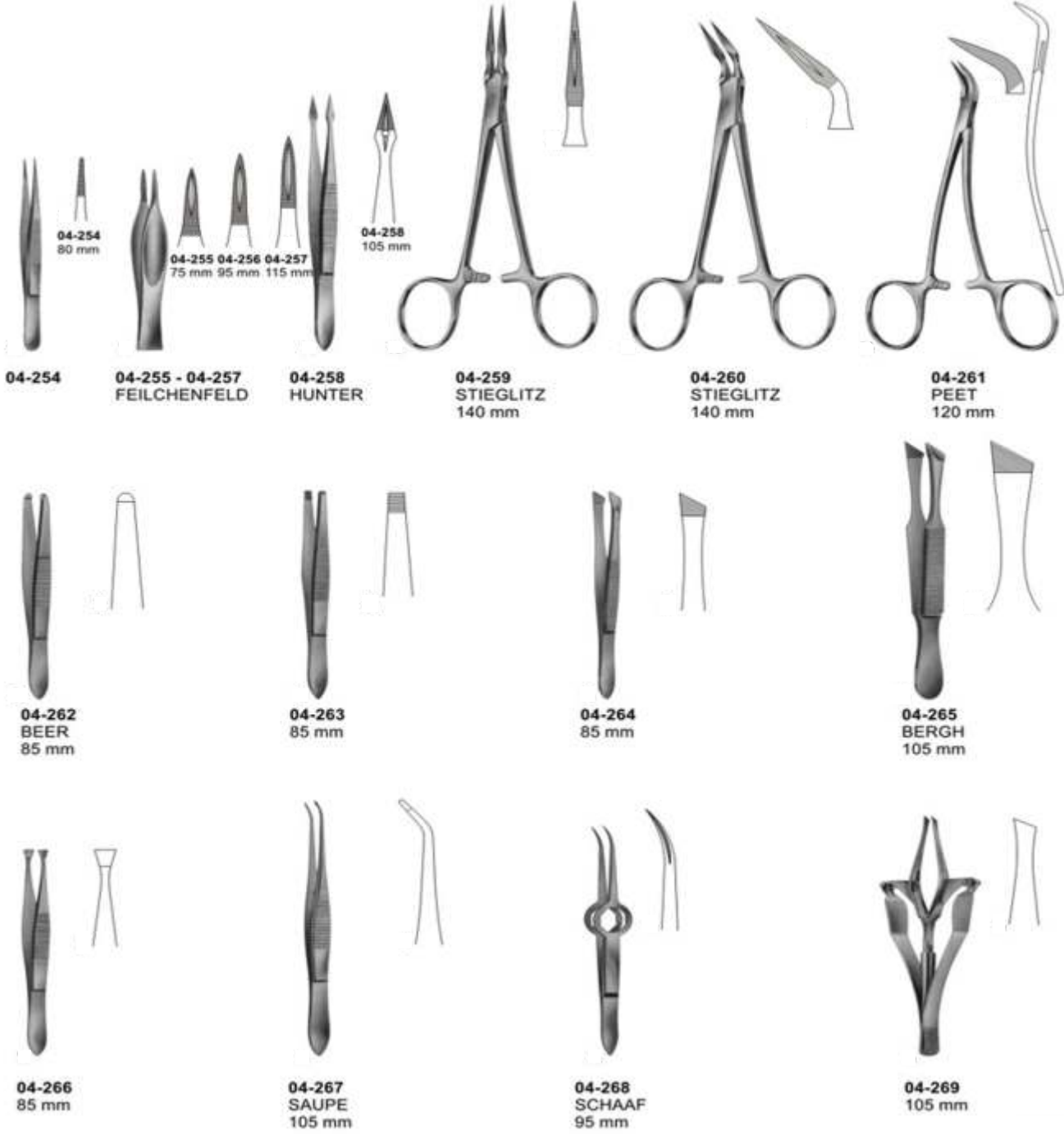

Sponge and Dressing Forceps



04-270  
BRYANT  
130 mm



04-271 - 04-273  
LISTER  
Sinus forceps



04-274  
without ratchet  
145 mm

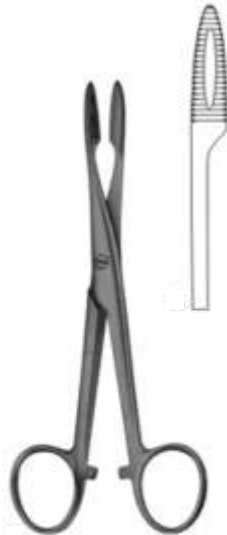

04-275  
with ratchet  
145 mm

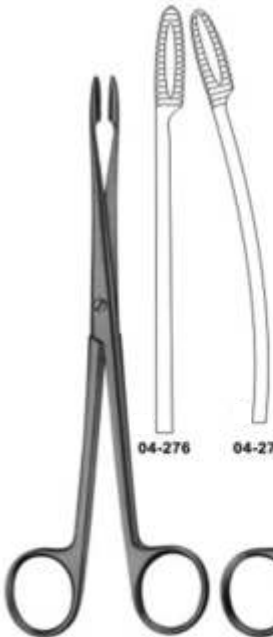

04-276 - 04-277  
GROSS  
without ratchet  
180 mm

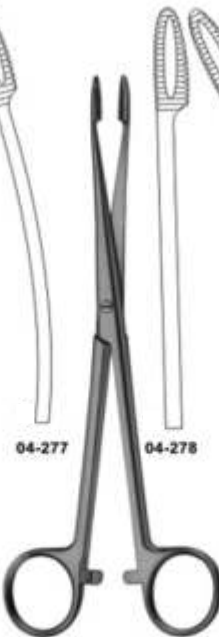

04-278 - 04-279  
GROSS  
with ratchet  
180 mm



04-280  
DUPLAY  
190 mm



04-281 - 04-282  
GROSS  
without ratchet  
200 mm

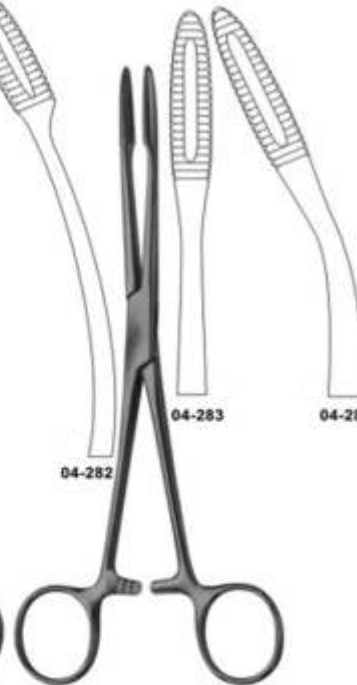

04-283 - 04-284  
GROSS  
200 mm

Dressing, Sponge holding, Organ and Tissue Grasping Forceps



04-285  
195 mm

04-286  
230 mm

04-285 - 04-286  
COLLIN



04-287  
160 mm

04-288  
160 mm

04-289  
170 mm

04-287 - 04-289  
COLLIN



04-290  
HEYWOOD-  
SMITH  
200 mm



04-291  
NOTO  
280 mm



04-292  
KELLY  
320 mm

Dressing, Sponge holding, Organ and Tissue Grasping Forceps



04-293 - 04-294  
FOERSTER-BALLENGER  
180 mm



04-293



04-294



04-295 - 04-296  
RAMPLEY



04-295  
180 mm



04-296  
250 mm



04-297 - 04-300  
FOERSTER-BALLENGER  
240 mm



04-297  
Smooth Jaws



04-298  
Smooth Jaws



04-299  
Serrated Jaws



04-300  
Serrated Jaws



04-301  
PENNINGTON  
155 mm



Intestinal Grasping Forceps

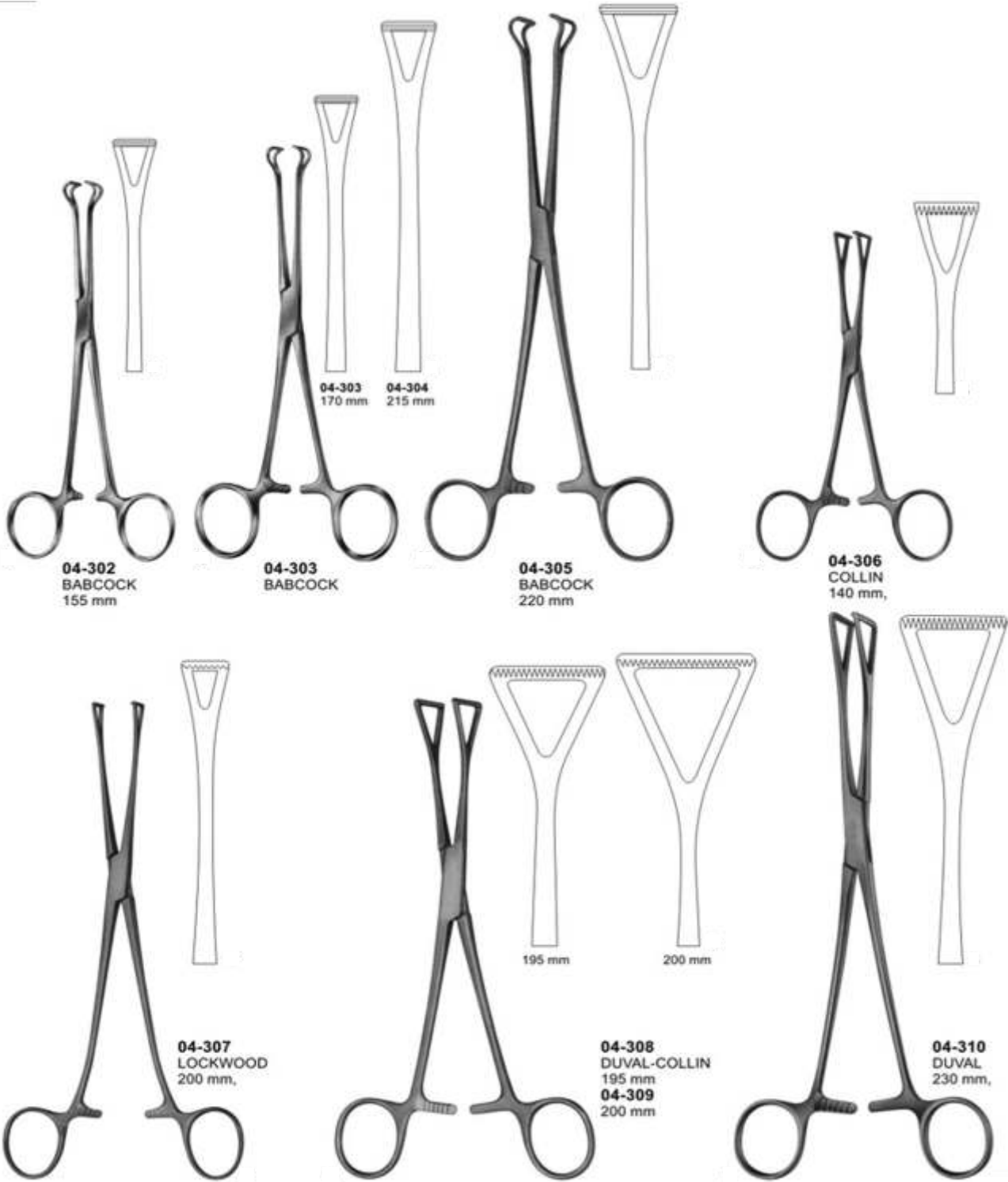

Artery Traction - and Tissue Grasping Forceps



**04-311**  
CHAPUT  
2 x 3 teeth  
125 mm



**04-312**  
BABY-ALLIS  
4 x 5 teeth  
130 mm



**04-313**  
BOYS-ALLIS  
5 x 6 teeth sharp  
155 mm



**04-314**  
ALLIS  
5 x 6 teeth  
155 mm



**04-315**  
LAHEY  
155 mm



**04-316**  
LAHEY  
155 mm



**04-317**  
BRAUN  
155 mm

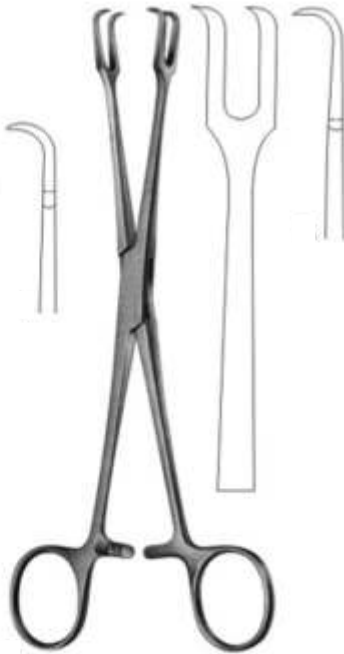

**04-318**  
MUSEUX  
200 mm

Towel Clamps



04-319  
JONES  
85 mm



04-320  
ENGL. MOD.  
85 mm



04-321 - 04-322  
SCHAEDEL  
85 mm



04-323  
DOYEN  
110 mm



04-324  
DOYEN  
180 mm

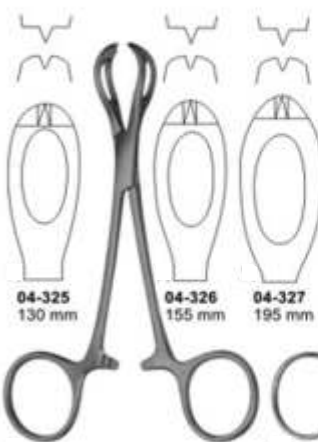

04-325  
130 mm

04-326  
155 mm

04-327  
195 mm

04-325 - 04-327  
LANE

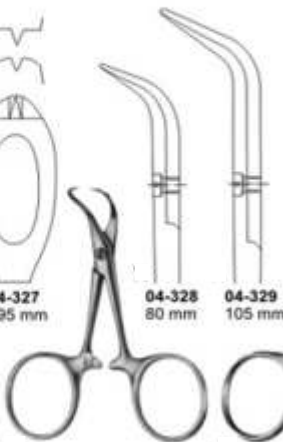

04-328  
80 mm

04-329  
105 mm

04-328 - 04-329  
BACKHAUS

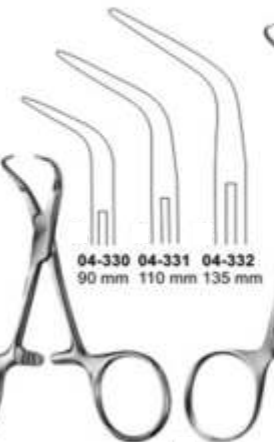

04-330 04-331 04-332  
90 mm 110 mm 135 mm

04-330 - 04-332  
BACKHAUS



04-333  
BACKHAUS-KOCHER  
135 mm

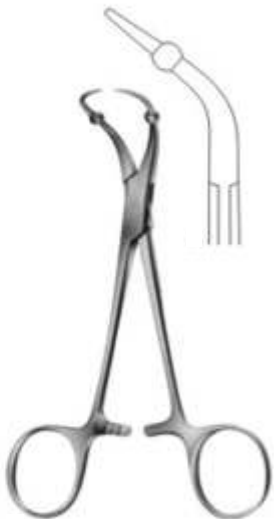

04-334  
ROEDER  
135 mm

## Muller Vessel Clips and Bulldog Clamps

Closing force

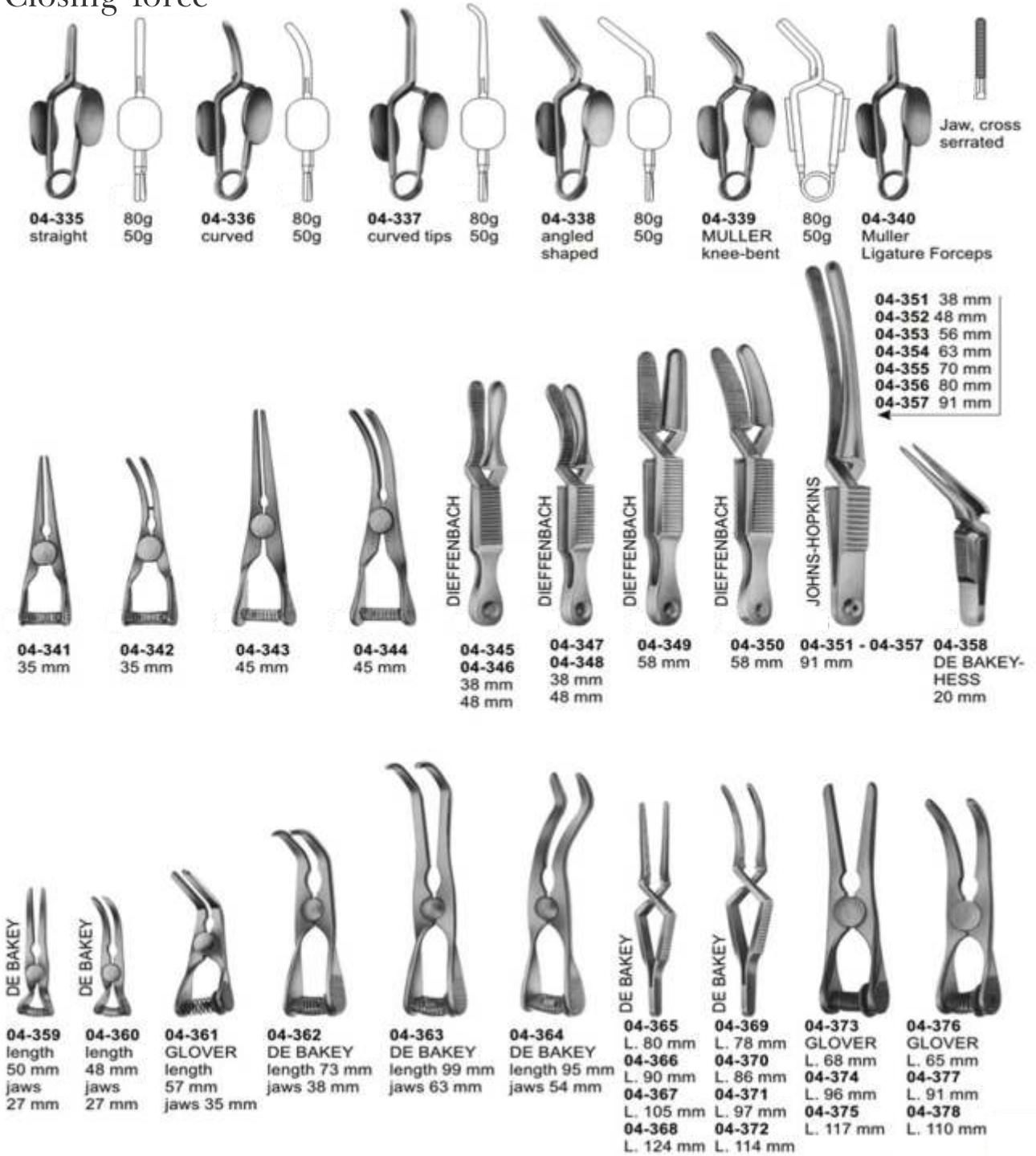

Delicate Haemostatic Forceps



04-379 - 04-382  
HALSTED-MOSQUITO  
200 mm



04-383 - 04-387  
HEISS  
200 mm



04-388 - 04-389  
HALSTED  
215 mm

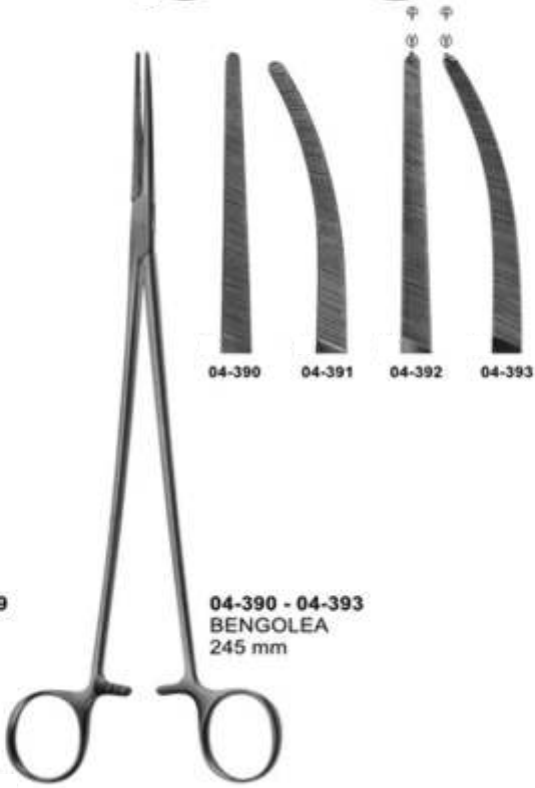

04-390 - 04-393  
BENGOLEA  
245 mm



04-394  
CRAFOORD  
245 mm

Delicate Haemostatic Forceps



04-395  
CARREL  
85 mm



04-396 - 04-399  
BABY-MOSQUITO  
(HARTMANN)  
100 mm

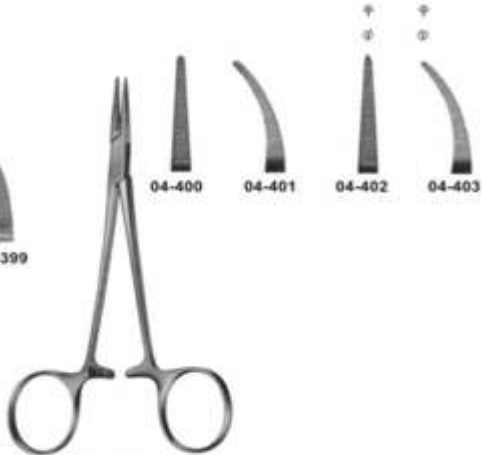

04-400 - 04-403  
MICRO-HALSTED  
125 mm



04-404 - 04-407  
HALSTED-MOSQUITO  
125 mm



04-408 - 04-409  
PROVIDENCE-HOSPITAL  
140 mm



04-410 - 04-411  
KELLY  
140 mm

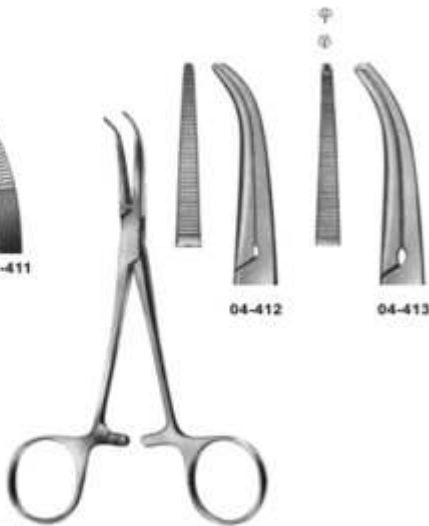

04-412 - 04-413  
DANDY  
Curved sideways  
140 mm

Delicate Haemostatic Forceps

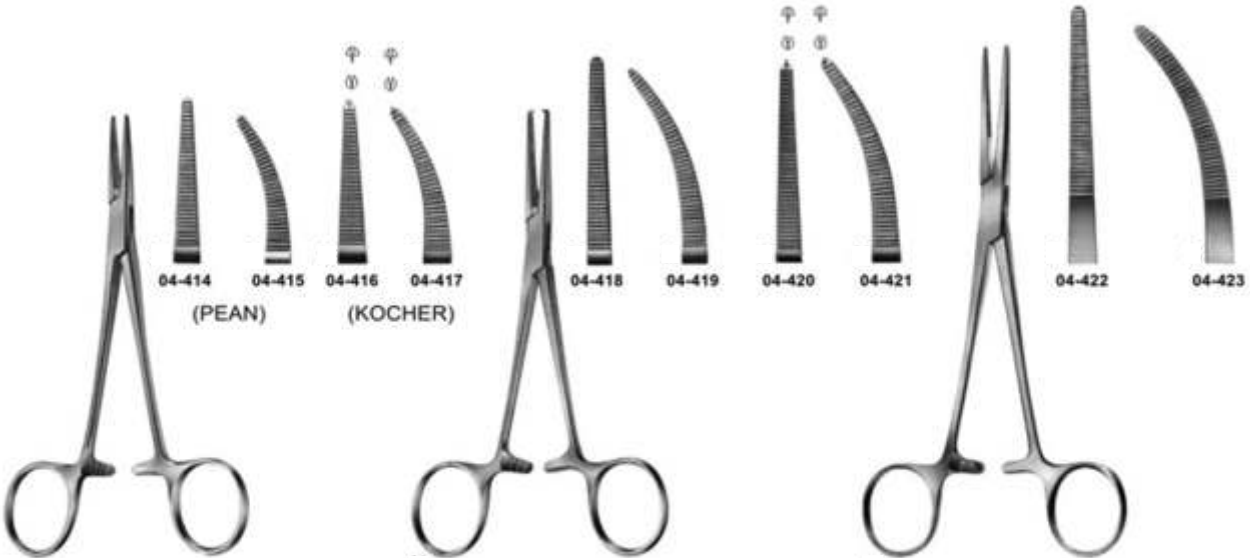

04-414 - 04-417  
BABY-CRILE  
140 mm

04-418 - 04-421  
CRILE  
140 mm

04-422 - 04-423  
RANKIN  
160 mm

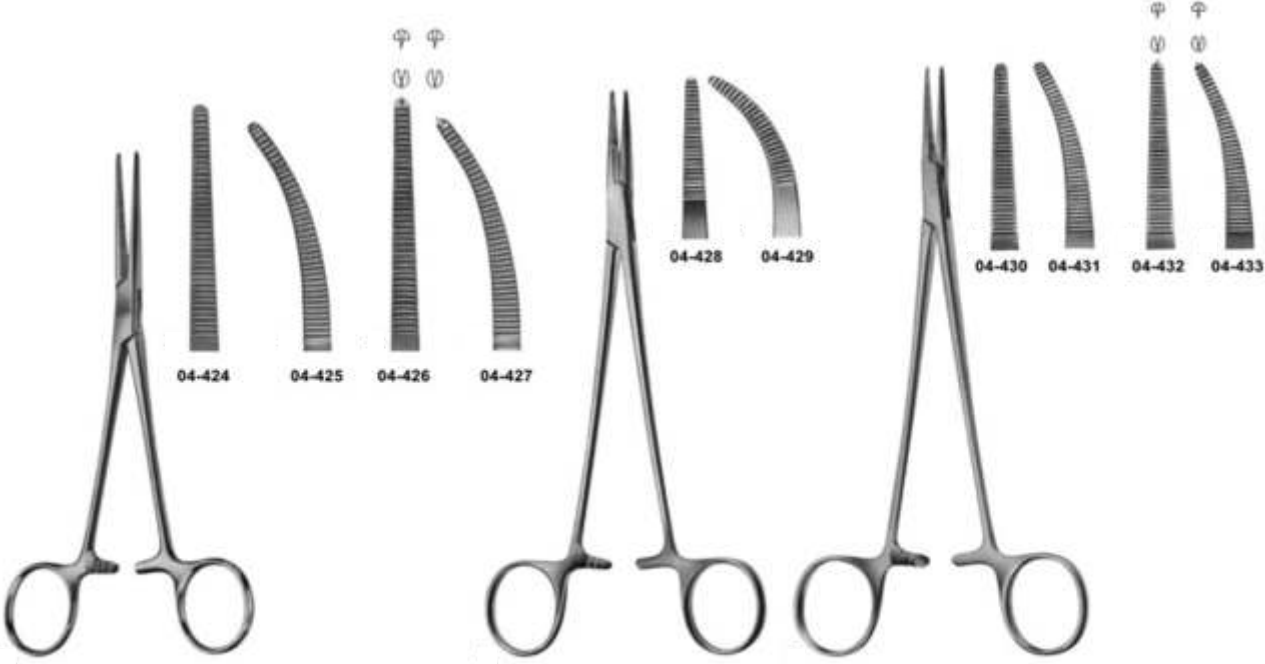

04-424 - 04-427  
CRILE  
160 mm

04-428 - 04-429  
ADSON  
185 mm

04-430 - 04-433  
HALSTED  
185 mm

Haemostatic Forceps



04-434 - 04-437  
PEAN  
Slender type

04-438 - 04-445  
SPENCER-WELLS  
Slender type

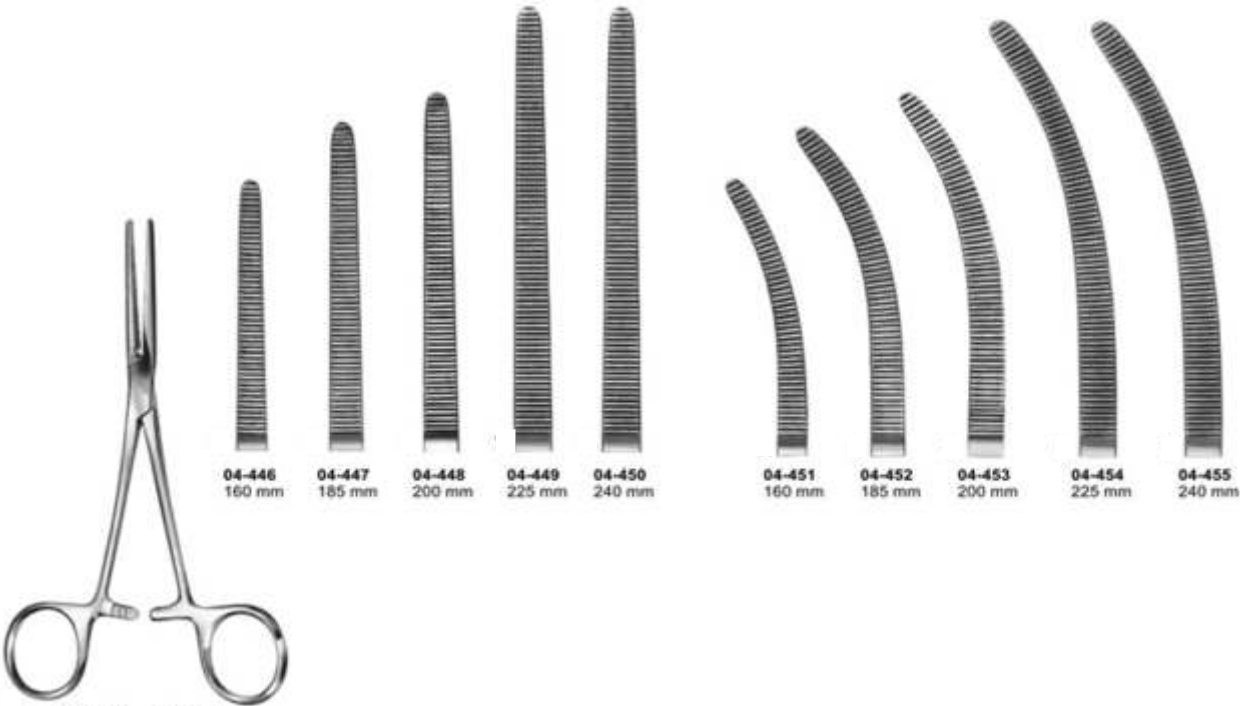

04-446 - 04-455  
ROCHESTER-PEAN

Haemostatic Forceps



04-456 - 04-461  
PEAN

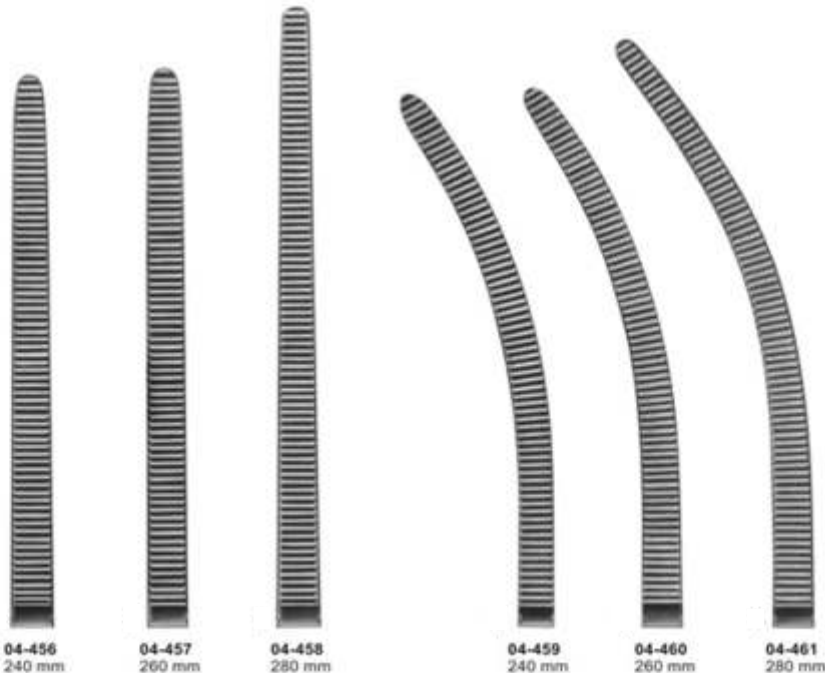

04-462  
KOCHER  
Strong Pattern  
145 mm



04-463 - 04-465  
ROCHESTER-  
OCHSNER



04-463 130 mm  
04-464 140 mm  
04-465 140 mm



04-466 - 04-467  
ROCHESTER-  
OCHSNER  
140 mm



04-466  
04-467

Haemostatic Forceps

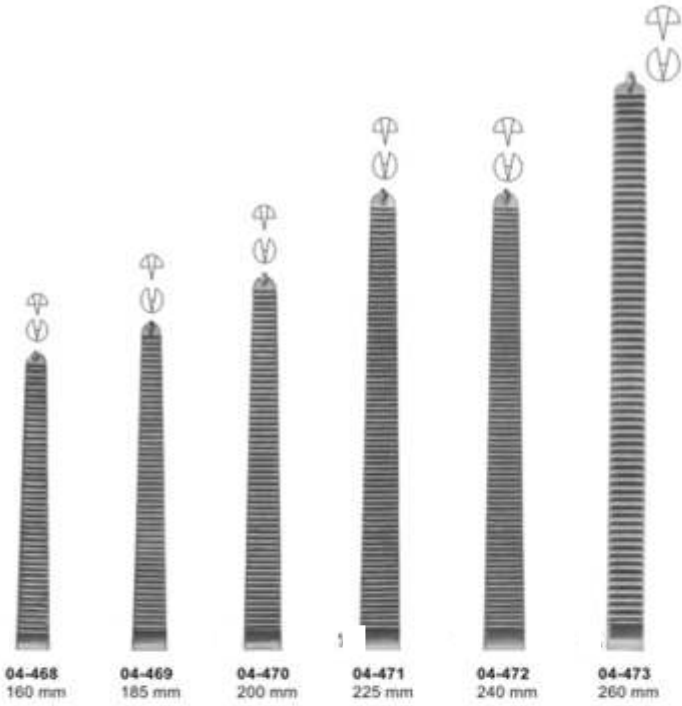

04-468 - 04-479  
KOCHER-OCHSNER

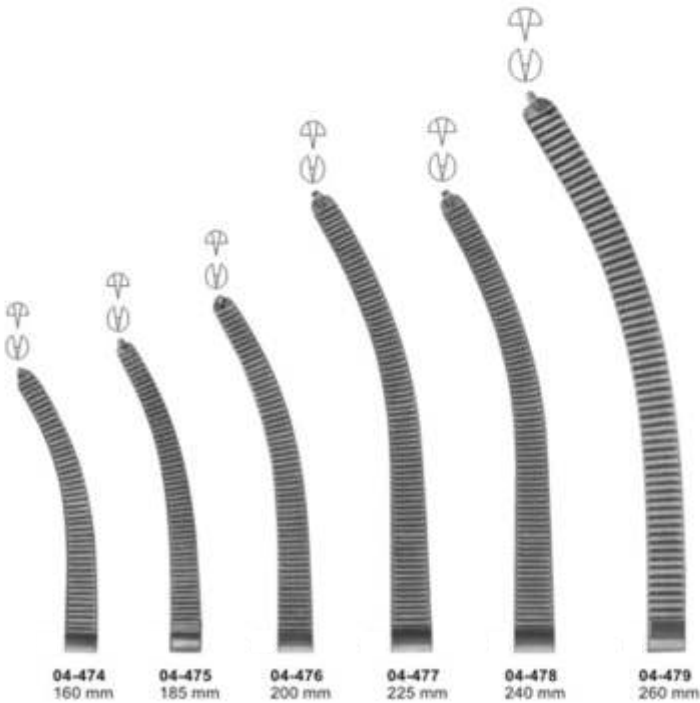

Haemostatic Forceps



04-480  
FRICKE  
Artery forceps  
130 mm



04-481  
KRONLEIN  
130 mm



04-482  
PEAN  
125 mm



04-483  
125 mm



04-484  
140 mm

04-483 - 04-484  
PEAN



04-485  
PEAN  
125 mm



04-486  
165 mm

04-487  
185 mm

04-486 - 04-487  
PEAN

Haemostatic Forceps, Special Pattern, Tonsil Forceps



04-488 - 04-491  
ROCHESTER-CARMALT



04-492 - 04-493  
MOYNIHAN



04-494 - 04-496  
PEAN



04-497 - 04-498  
NEGUS  
190 mm

04-499  
MIKULICZ  
185 mm

Dissecting- and Ligature Forceps



**04-500**  
MIXTER-O'SHAUGHNESSY  
190 mm



**04-501**  
HEISS  
195 mm



**04-502 - 04-506**  
RUMEL  
240 mm

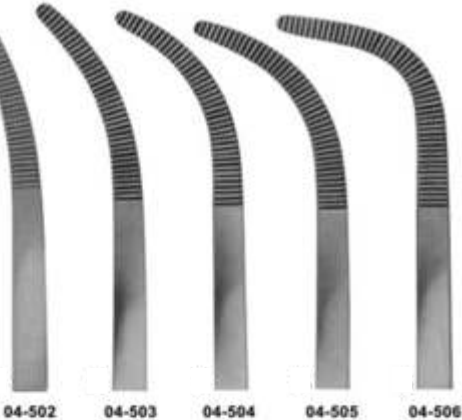

**04-502**   **04-503**   **04-504**   **04-505**   **04-506**



**04-507**  
FINOCHIETTO  
245 mm



**04-508**  
MIXTER  
230 mm



**04-509**  
LAWRENCE  
270 mm



**04-510 - 04-511**  
ZENKER

**04-510**  
300 mm

**04-511**  
290 mm

Hysterectomy Forceps, Vaginal Clamps  
and Compression Forceps



04-512  
WERTHEIM  
Hysterectomy forceps  
255 mm



04-513  
WERTHEIM  
Parametrium clamp  
260 mm



04-514 - 04-516  
DICK



04-514 255 mm  
04-515 265 mm  
04-516 275 mm

Hysterectomy Forceps, Vaginal Clamps  
and Compression Forceps



Needle Holders for micro surgery



**05-101**  
ROHRSCHEIDER  
with copper inserts  
100 mm



**05-102**  
KALT  
with catch  
135 mm



**05-103**  
ARRUGA  
with catch  
135 mm



**05-104 - 105**  
CASTROVIEJO  
with catch  
145 mm



**05-106 - 107**  
without Catch  
160 mm



**05-108 - 109**  
without catch  
185 mm



**05-110 - 111**  
JACOBSON  
185 mm



**05-112**  
without catch  
195 mm



**05-113 - 114**  
YASARGIL  
with catch  
200 mm

Needle Holders



05-115 150 mm  
05-116 180 mm  
05-117 200 mm

05-115 - 117  
MAYO-HEGAR  
medium fine patterns



05-118 150 mm  
05-119 175 mm  
05-120 205 mm  
05-121 205 mm

05-118 - 121  
HEGAR  
heavy patterns



05-122  
HEANEY (HEGAR)  
200 mm



05-123  
JAMESON  
230 mm



05-124  
WANGENSTEEN  
275 mm



05-125  
MASSON  
265 mm

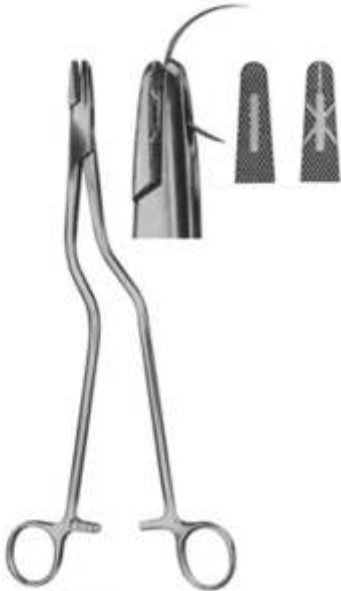

05-126  
MASSON-LUETHY  
255 mm

Needle Holders



05-127 - 128  
HEGAR-OLSEN  
255 mm

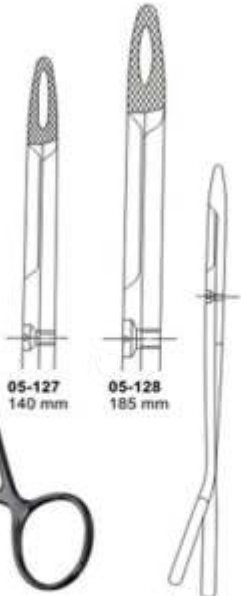

05-127  
140 mm

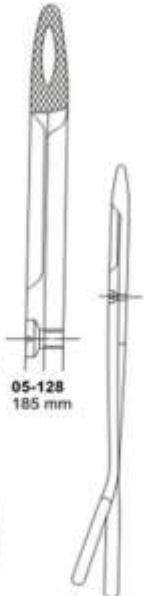

05-128  
185 mm



05-129  
GILLIES  
150 mm



05-130  
GILLIES  
160 mm



05-131  
EISELSBERG  
115 mm



05-132  
SCHOEMAKER-LOTH  
125 mm



05-133  
CRILE  
150 mm



05-134  
TOENNIS  
Elastic pattern for dura-or  
intestinal suture. 180 mm

Needle Holders



05-135 - 05-137  
MATHIEU

05-138 - 05-139  
MATHIEU-STILLE  
Very heavy models

05-140  
BOYNTON  
125 mm

05-141  
EISELSBERG-MATHIEU  
For palate suture  
195 mm

05-142 - 05-143



05-144

05-145

05-146



05-147  
YOUNG-  
HRYNTSCHAK  
With 1 needle  
240 mm

05-148  
YOUNG-MILLIN  
With 1 needle  
200 mm



05-149  
MILLIN  
Ligature holding  
forceps. 245 mm

Suture Instruments - Reverdin Needles



**05-150**  
KRONECKER  
for right hand  
blunt  
155 mm



**05-151**  
KRONECKER  
for left hand  
blunt  
155 mm



**05-152**  
DESCHAMPS  
for right hand  
steep turn  
blunt  
225 mm



**05-153**  
DESCHAMPS  
for left hand  
steep turn  
blunt  
225 mm



**05-154**  
DESCHAMPS  
for right hand  
steep turn blunt  
225 mm



**05-155**  
DESCHAMPS  
for left hand  
steep turn blunt  
225 mm



**05-156**  
DESCHAMPS  
for right hand  
steep turn blunt  
230 mm



**05-157**  
DESCHAMPS  
for left hand  
steep turn blunt  
230 mm



**05-158**  
DESCHAMPS  
for right hand blunt  
215 mm



**05-159**  
DESCHAMPS  
for left hand blunt  
215 mm



**05-160**  
DESCHAMPS  
for right hand blunt  
210 mm



**05-161**  
DESCHAMPS  
for left hand  
blunt. 210 mm

Probes



05-162 130 mm  
05-163 145 mm  
05-164 160 mm  
Directors



05-165  
DOYEN  
145 mm  
Directors



05-166  
NELATON  
160 mm  
Directors



05-167  
Director with tip  
Diam. Of tip 3,3 mm  
140 mm



05-168  
BRODIE  
Director with tip,  
Diam. Of tip 3,5 mm  
200 mm



Nr. 1  
05-169  
LOCKHART-MUMMERY  
165 mm



Nr. 2  
05-170  
LOCKHART-MUMMERY  
165 mm

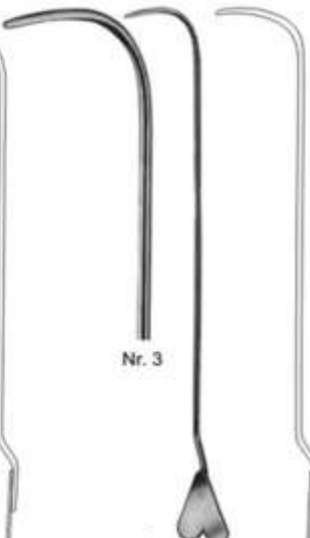

Nr. 3  
05-171  
LOCKHART-MUMMERY  
165 mm

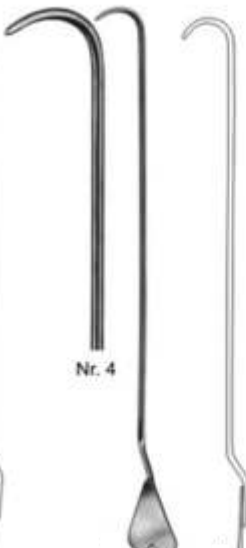

Nr. 4  
05-172  
LOCKHART-MUMMERY  
165 mm



05-173  
Director with wire  
loop, malleable

Probes



05-174  
2,5 mm  
05-175  
2,5 mm  
05-176  
3,0 mm

05-174 145 mm  
05-175 160 mm  
05-176 200 mm  
Probes with eye



1,5 mm

05-177  
Myrtle leaf probe  
145 mm



2,0 mm

05-178 130 mm  
05-179 145 mm  
05-180 160 mm  
05-181 180 mm  
05-182 200 mm



05-183  
Probes



05-184  
Double ended probe,  
malleable, diam. of tips  
3 mm with hole  
190 mm



05-185  
Double ended probes,  
tin, malleable,  
diam. of tips  
3,5 mm with hole  
250 mm, 300 mm



05-186  
Double ended probes,  
tin, malleable,  
diam. of tips 4 mm  
400 mm



∅ tip  
05-187 1,5 mm  
05-188 2,0 mm  
05-189 2,5 mm  
300 mm

## Suturing Instrument Set, Pocket Instrument Set



### 05-190

Suturing instruments set, in metal case consisting of: Scissors, curved, sharp/sharp, 115mm  
25 MICHEL clip, 16 x 3mm  
1 Delicate tissue forceps, 130mm  
1 Scalpel, bellied  
1 MATHIEU needle holder, 140mm  
1 Perforated metal case, stainless containing:  
1 Suture needle  
1 item 1 item



### 05-191

Pocket instrument set, in metal case consisting of:

#### Bottom tray

1 MATHIEU needle holder, 140mm  
1 MICHEL clip forceps, combined  
1 Myrtle leaf probe, 130mm  
1 Sharp double curette  
1 Skin hook  
1 Detachable scalpel handle, no.4  
1 Perforated metal case, containing  
6 Scalpel blades  
1 Perforated metal case, stainless, containing  
1 Suture needle  
1 item  
1 item

#### Top tray

1 Tissue forceps, 130mm  
1 KOCHER haemostatic forceps, 130mm  
1 Straight surgical scissors, 130mm  
1 Dissecting forceps, 130mm  
1 FEILCHENFELD splinter forceps, 115mm  
25 MICHEL clip, 16 x 3mm  
1 Flacon of suture skin, sterile in alcohol



### 05-192

Pocket instrument set, in metal case consisting of:

#### Bottom tray

1 MAYO-HEGER needle holder, 150mm  
1 MICHEL clip forceps, combined  
1 Myrtle leaf probe, 130mm  
1 Sharp double curette  
1 Skin hook  
1 Detachable scalpel handle, no. 4  
1 Perforated metal case, consisting  
6 Scalpel blades  
1 Perforated metal case, stainless, consisting:  
1 Suture needle  
1 item, & 1 item

#### Top tray

1 Tissue forceps, 130mm  
1 CRILE haemostatic forceps, 140mm  
1 Straight surgical scissors, 130mm  
1 Dissecting forceps, 130mm  
1 FEILCHENFELD splinter forceps, 115mm  
25 MICHEL clip, 16 x 3mm  
1 Flacon of suture silk, sterile in alcohol



## Fine Wound Retractors (Dura and Skin Retractors)

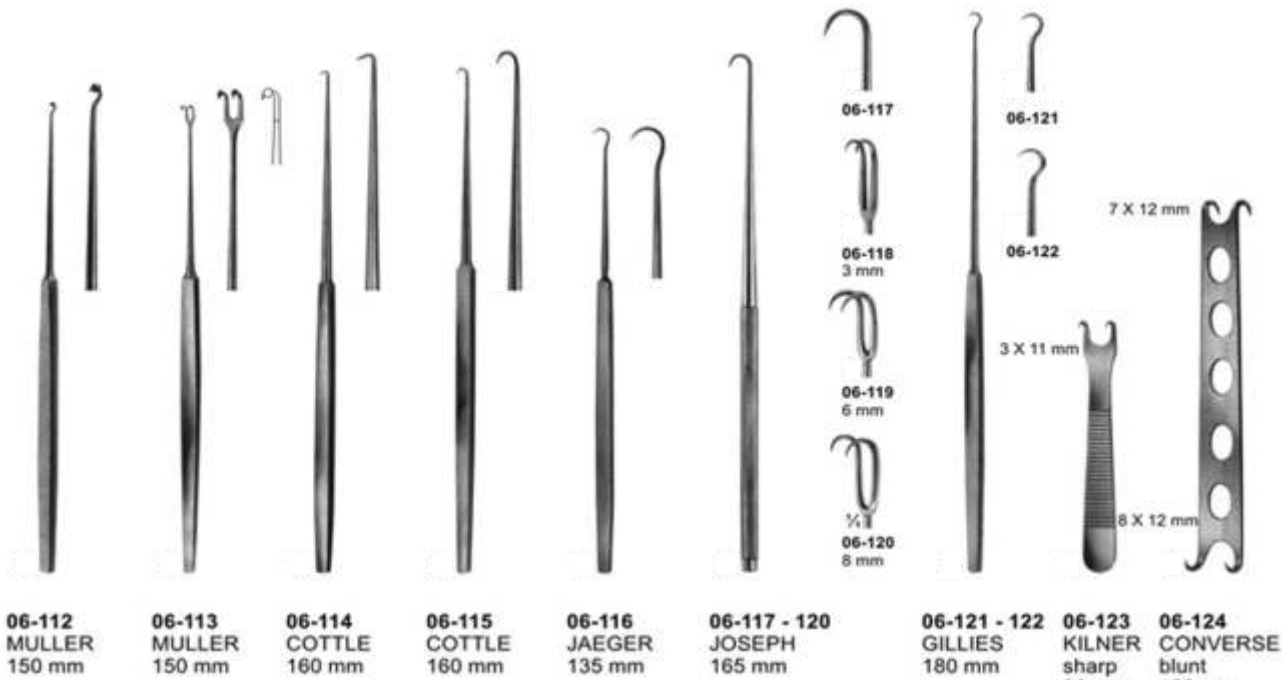
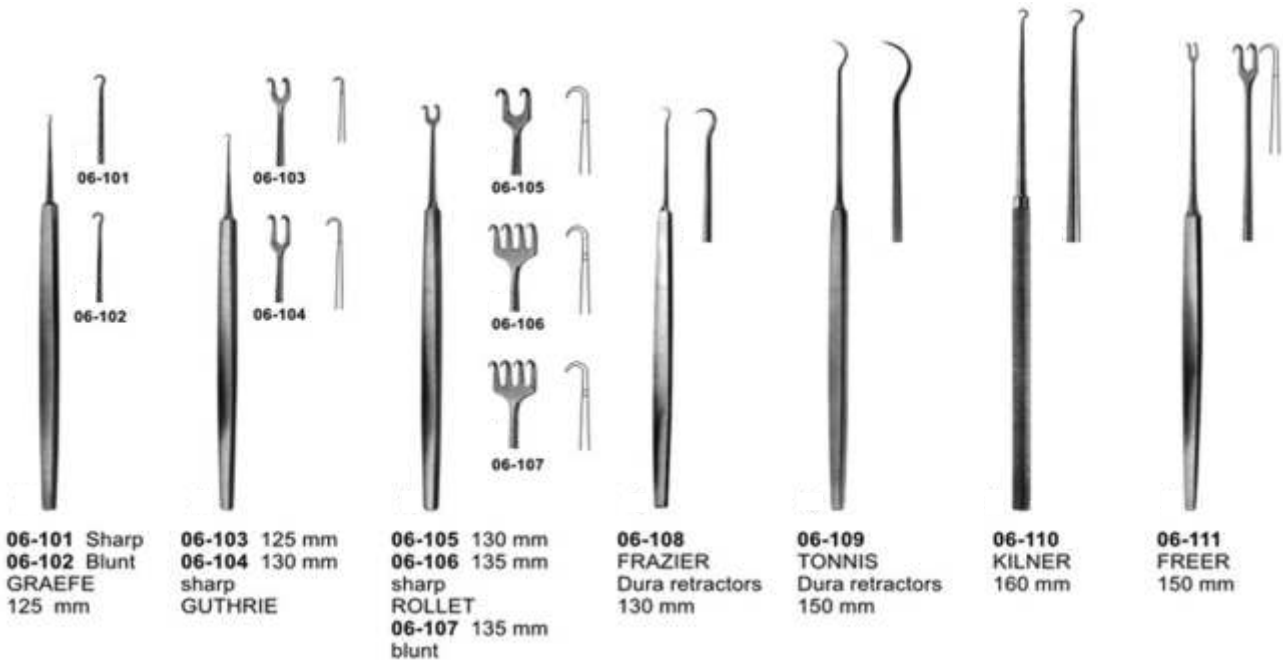

Retractors With Treabgle handle

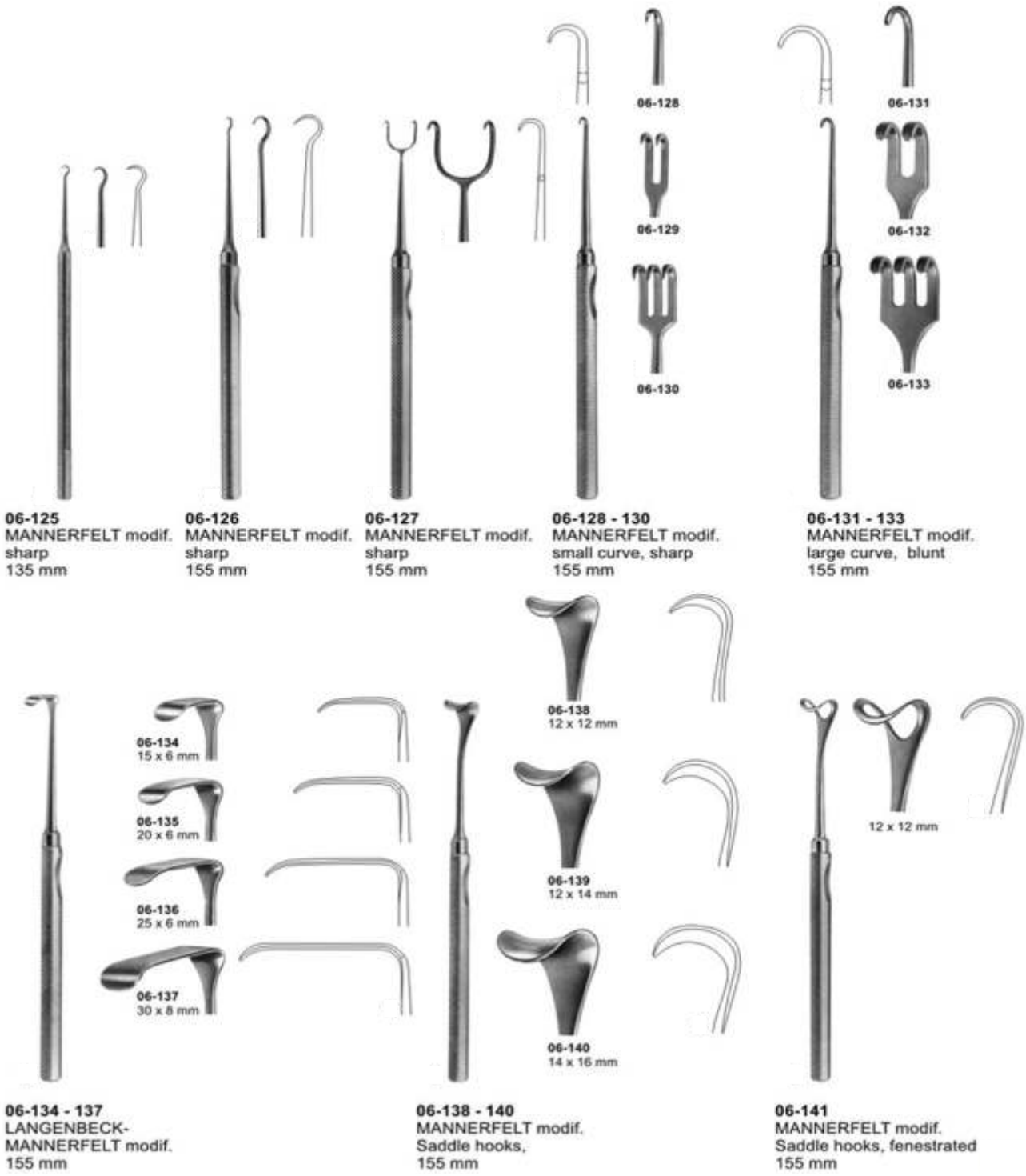

**06-125**  
MANNERFELT modif.  
sharp  
135 mm

**06-126**  
MANNERFELT modif.  
sharp  
155 mm

**06-127**  
MANNERFELT modif.  
sharp  
155 mm

**06-128 - 130**  
MANNERFELT modif.  
small curve, sharp  
155 mm

**06-131 - 133**  
MANNERFELT modif.  
large curve, blunt  
155 mm

**06-134 - 137**  
LANGENBECK-  
MANNERFELT modif.  
155 mm

**06-138 - 140**  
MANNERFELT modif.  
Saddle hooks,  
155 mm

**06-141**  
MANNERFELT modif.  
Saddle hooks, fenestrated  
155 mm

Retractors



6 x 12 mm

06-142  
MASING  
140 mm



10 x 12 mm

06-143  
COTTLE  
140 mm



06-144  
9 x 9 mm



06-145  
9 x 12 mm



06-146  
11 x 14 mm



06-147  
12 x 16 mm



06-148  
13 x 18 mm

06-144 - 148  
DESMARRES  
140 mm



06-149  
13 x 13 mm

06-149 - 150  
KONIG  
180 mm

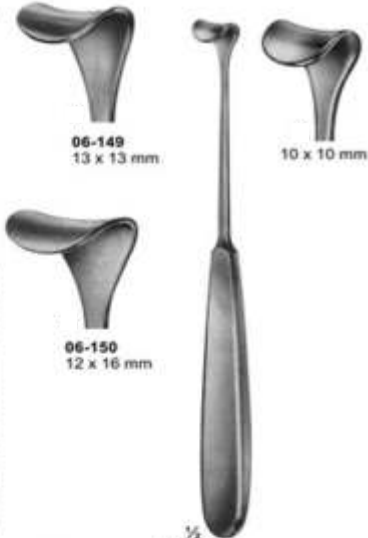

10 x 10 mm

06-150  
12 x 16 mm

06-151  
CUSHING-KOCHER  
175 mm

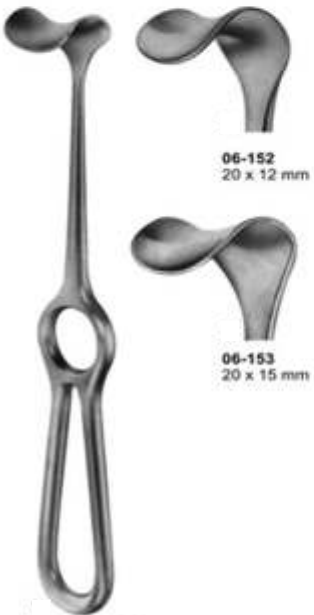

06-152  
20 x 12 mm



06-153  
20 x 15 mm

06-152 - 153  
KOCHER  
205 mm



13 x 6 mm

06-154  
SCHOENBORN  
200 mm



06-155  
10 x 13 mm



06-156  
14 x 18 mm

06-155 - 156  
CUSHING  
205 mm



20 x 15 mm

20 x 19 mm

06-157  
205 mm



06-158  
11 x 14 mm



06-159  
13 x 18 mm



06-160  
15 x 22 mm

06-158 - 160  
CUSHING  
250 mm

Retractors



06-161 - 163  
ROUX  
Set  
165 mm

06-161  
23 x 30 mm

06-162  
28 x 38 mm

06-163  
33 x 45 mm

06-164 - 165  
ROUX

06-164  
25 x 29 mm  
150 mm

06-165  
30 x 38 mm  
160 mm



06-166  
CZERNY  
175 mm

47 x 13 mm  
41 x 13 mm

37 x 25 mm  
42 x 25 mm

06-167  
MATHIEU  
200 mm

26 x 15 mm  
22 x 15 mm

39 x 15 mm  
43 x 15 mm

06-168  
US-ARMY  
220 mm

Retractors

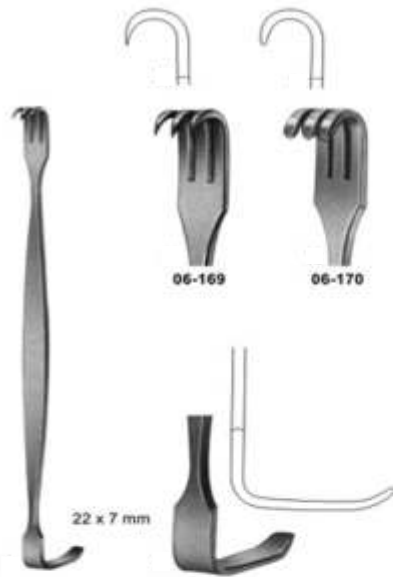

**06-169 - 06-170**  
BABY-SENN-MILLER  
155 mm



**06-171**  
SENN-MILLER  
165 mm



**06-172**  
COLLIN-HARTMANN  
150 mm



**STERBERG**  
**06-173** 120 mm  
**06-174** 130 mm  
**06-175** 135 mm  
**06-176** 140 mm



**06-177**  
LUER  
110 mm

**06-178**  
ROSE  
130 mm

**06-179**  
BABY-ROUX  
135 mm



**06-180**  
PARKER  
135 mm

**06-181**  
CRILE  
110 mm



**06-182**  
FARABEUF  
150 mm



**06-183**  
COLLIN  
150 mm

Bone Retractors and Retractors



06-184  
KOCHER  
sharp  
205 mm



06-185  
KOCHER  
sharp  
220 mm



06-186  
KOCHER  
sharp  
220 mm



06-187  
VOLKMANN  
blunt  
220 mm



06-188  
VOLKMANN  
sharp  
220 mm



06-189 - 06-196  
VOLKMANN  
225 mm



Sharp



Blunt



06-189  
9 x 6 mm



06-190  
9 x 13 mm



06-191  
9 x 19 mm



06-192  
9 x 29 mm



06-193  
8,5 x 8 mm



06-194  
8,5 x 13 mm



06-195  
8,5 x 19 mm



06-196  
8,5 x 29 mm

Restractors



06-197  
15 x 15 mm  
220 mm



06-198  
20 x 22 mm  
215 mm



06-199  
28 x 28 mm  
235 mm

06-197 - 06-199  
MIDDELDORPF



38 x 18 mm

06-200  
BUCHS  
205 mm



67 x 17 mm



06-201  
CASPAR  
210 mm

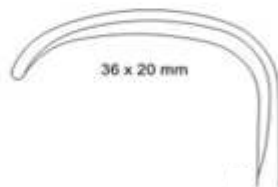

36 x 20 mm

06-202  
KOCHER  
230 mm

Retractors, Vario Retractors System



- 06-203-06-209  
BRUNNER  
275 mm
- 06-203 80 x 20
- 06-204 100 x 25
- 06-205 120 x 25
- 06-206 130 x 30
- 06-207 140 x 30
- 06-208 160 x 30
- 06-209 180 x 30



06-210  
Handle with cold  
light carrier for  
retractor blades.  
280 mm



Handle arrange-  
ment verriable

Retractors, Lung Spatulas

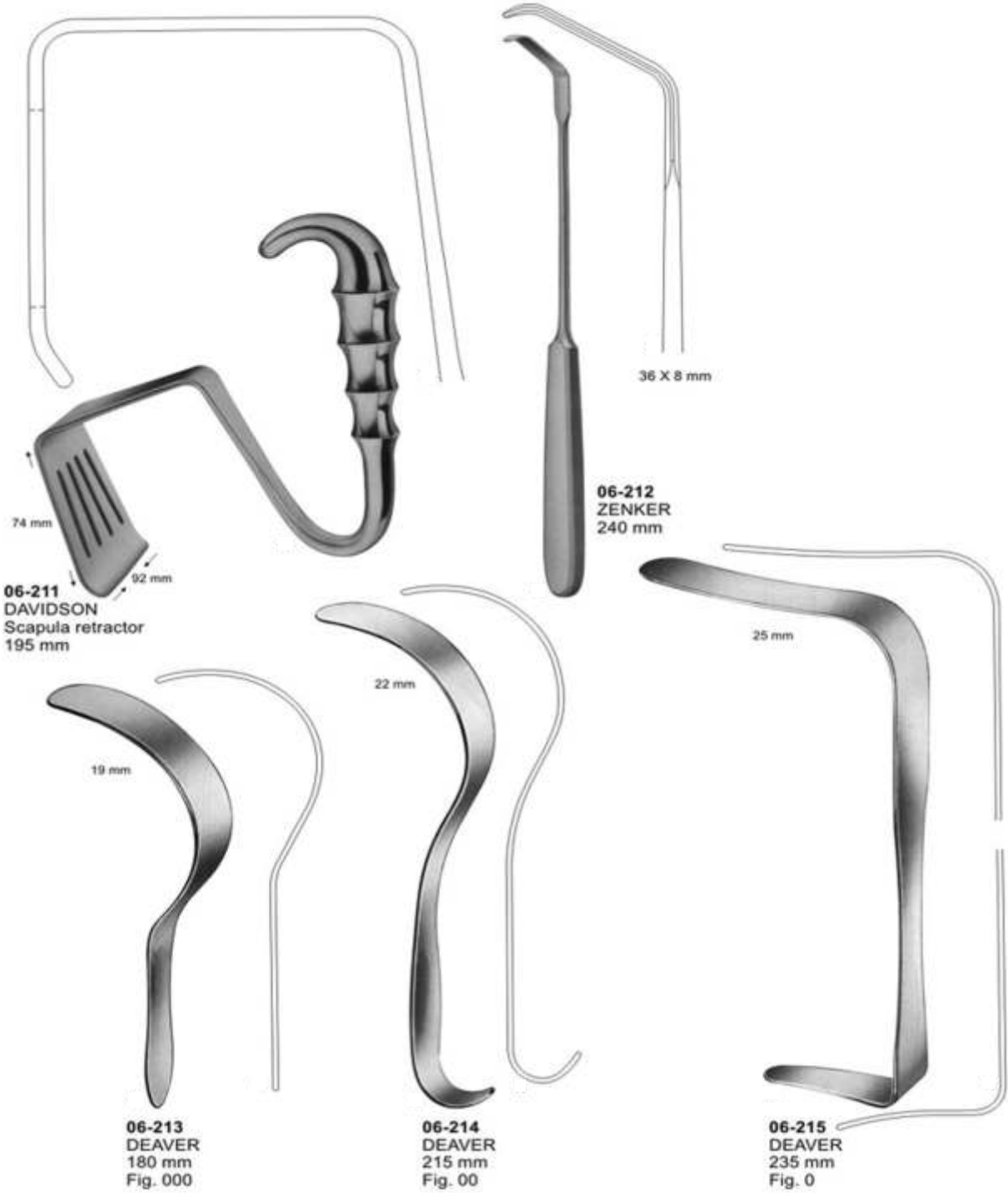

**Retractors for deep surgery  
(Abdominal Retractors)**

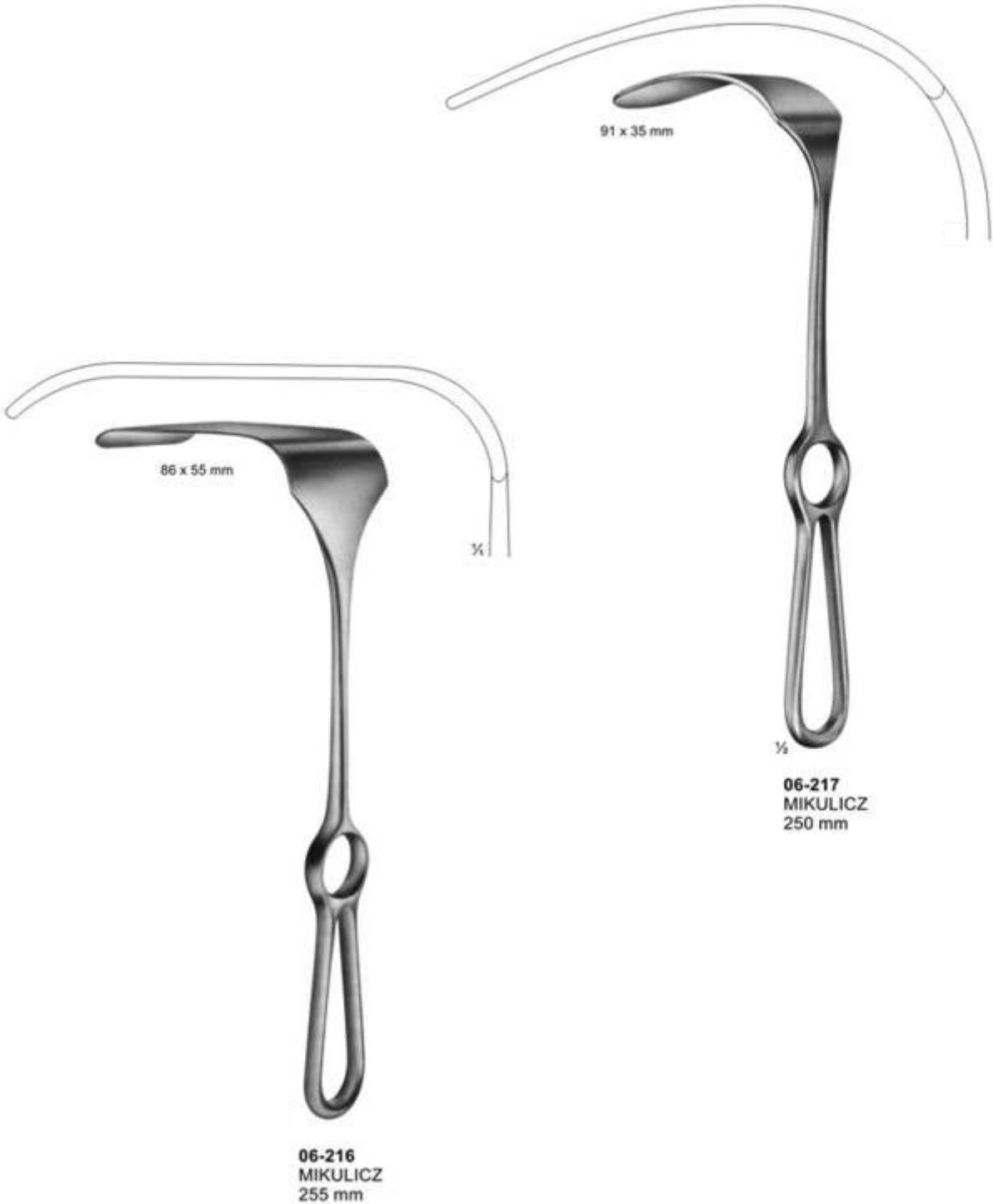

Retractors. Abdominal Retractors

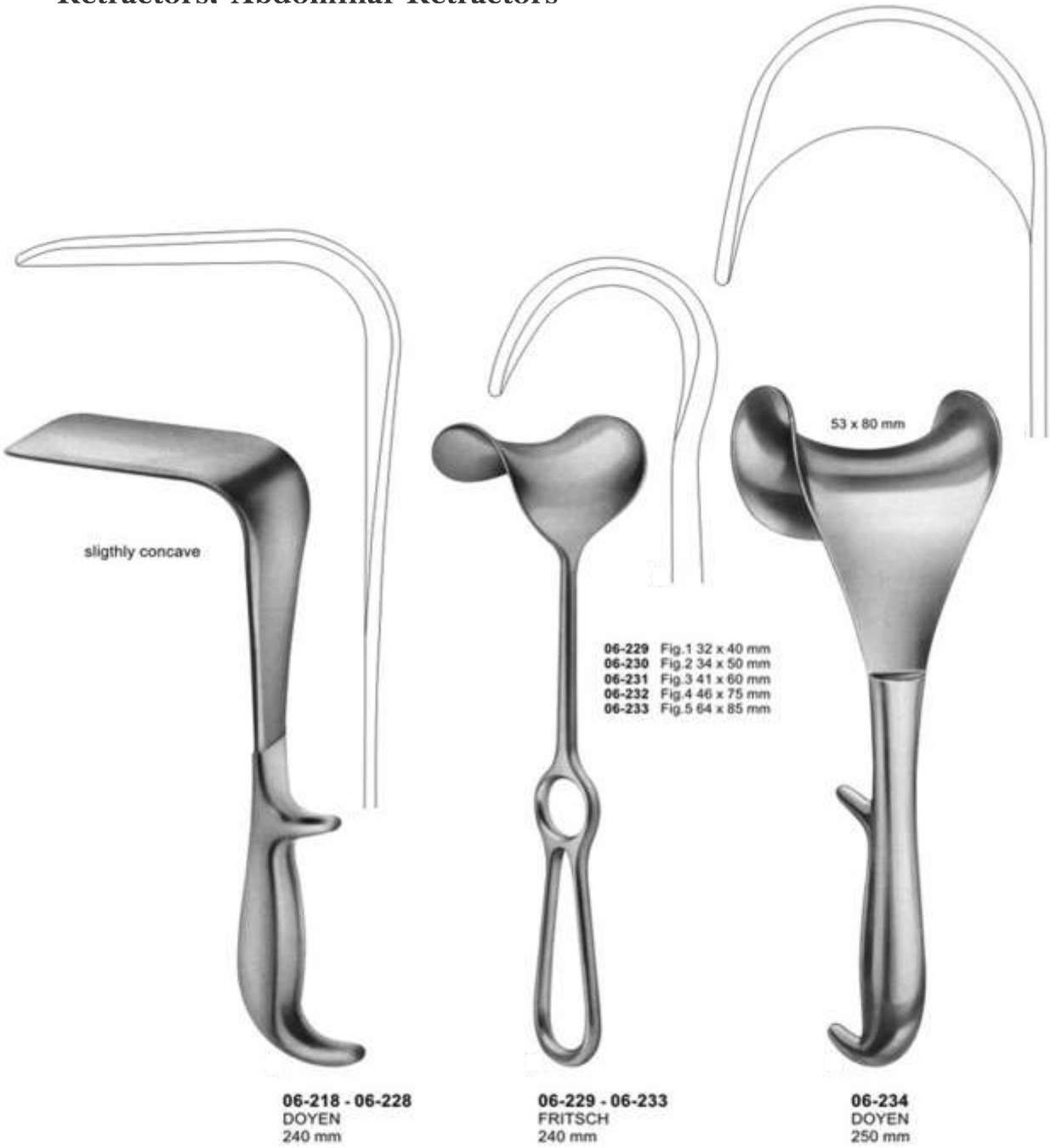

- 06-229 Fig.1 32 x 40 mm
- 06-230 Fig.2 34 x 50 mm
- 06-231 Fig.3 41 x 60 mm
- 06-232 Fig.4 46 x 75 mm
- 06-233 Fig.5 64 x 85 mm

width of blades  
35 mm, 45 mm, 60 mm

length of blades  
62 mm  
92 mm  
122 mm  
160 mm

06-218, 06-222, 06-226  
06-219, 06-223, 06-227  
06-220, 06-224, 06-228  
06-221, 06-225

Abdominal- and Intestinal Spatulas  
Bauch- und Darmspatel



**06-235**  
LERICHE  
255 mm

**06-236**  
KUMMEL  
Mealleable  
285 mm

**06-237**  
MIKULICZ  
29 mm  
250 mm

**06-238 - 06-239**  
KADER  
**06-238** 30 mm  
**06-239** 40 mm  
270 mm

Self-Retaining Retractors



**06-240**  
WEITLANER  
sharp  
130 mm



**06-241**  
WULLSTEIN  
sharp  
130 mm

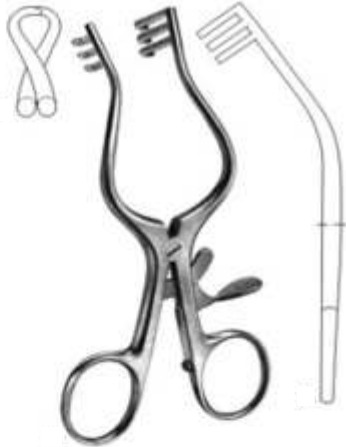

**06-242**  
WULLSTEIN  
blunt  
130 mm



**06-243**  
WEITLANER  
sharp  
165 mm



**06-244**  
PLESTER  
blunt  
110 mm



**06-245**  
PERKINS  
130 mm

Special Retractors



**06-246**  
JOLL ( FRIEDMAN )  
Thyroid- and vaginal retractor  
155 mm



**06-247**  
JACKSON BURROWS  
Retractor, blunt  
185 mm



**06-248**  
GELPI  
Vaginal retractor  
135 mm



**06-249**  
GELPI  
Skin- and vaginal retractor  
175 mm



**06-250**  
DE BAKEY  
Femur retractor  
145 mm

Lamina Spreaders

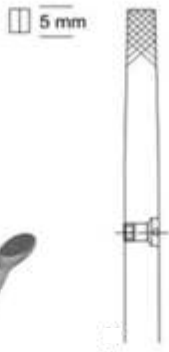

06-251  
CLOWARD  
155 mm

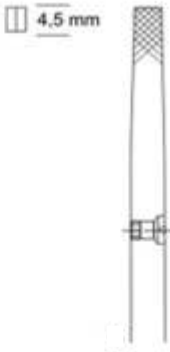

06-252  
CLOWARD  
135 mm



06-253  
INGE  
170 mm

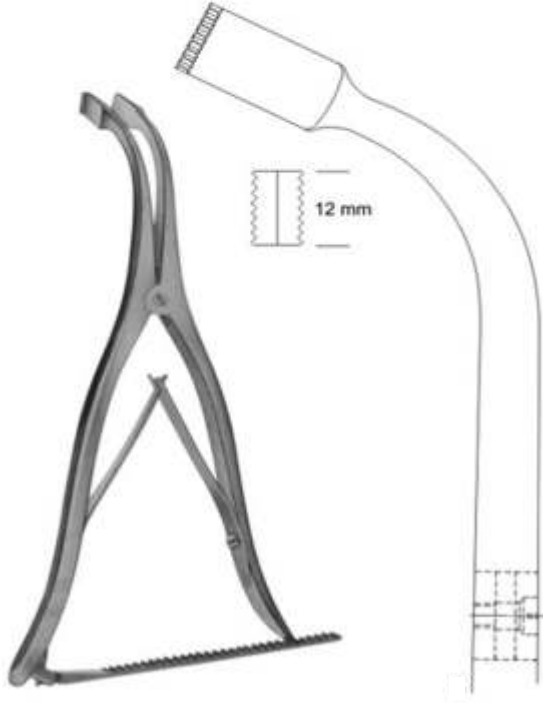

06-254  
INGE  
275 mm

Abdominal Retractors



**06-255**  
**GOSSET**  
Blades:38 mm deep



**06-256**  
**HERTZLER**  
Blades 20 X 25 mm

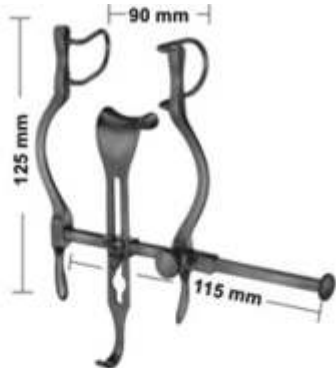

**06-257**  
**BALFOUR-BABY**  
Lateral blades 27 mm deep  
Center blade 21x24 mm



**06-258**  
**GOSSET**  
Blades:55mm deep



**06-259**  
**GOSSET**  
Lateral blades 58 mm deep  
Center blade 59 x 57 mm

## Abdominal Retractors

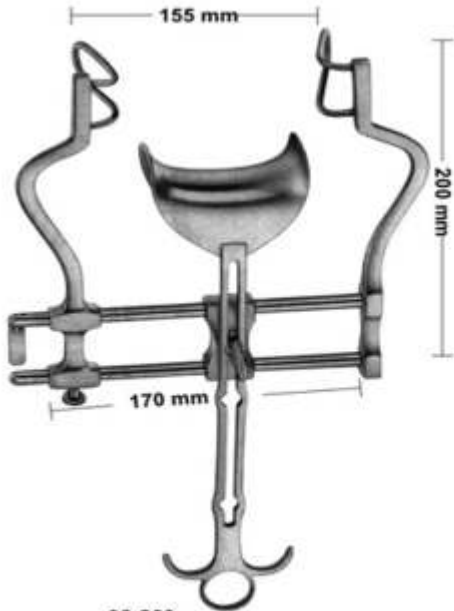

**06-260**  
BALFOUR  
Lateral blades 60 mm deep  
Center blade 47 x 80 mm

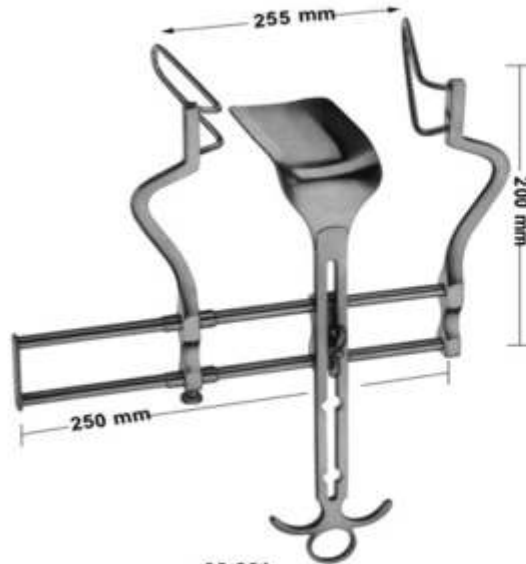

**06-261**  
BALFOUR  
Lateral blades 105 mm deep  
Center blade 107x 59 mm



**06-262**  
Center blade only  
54x80 mm

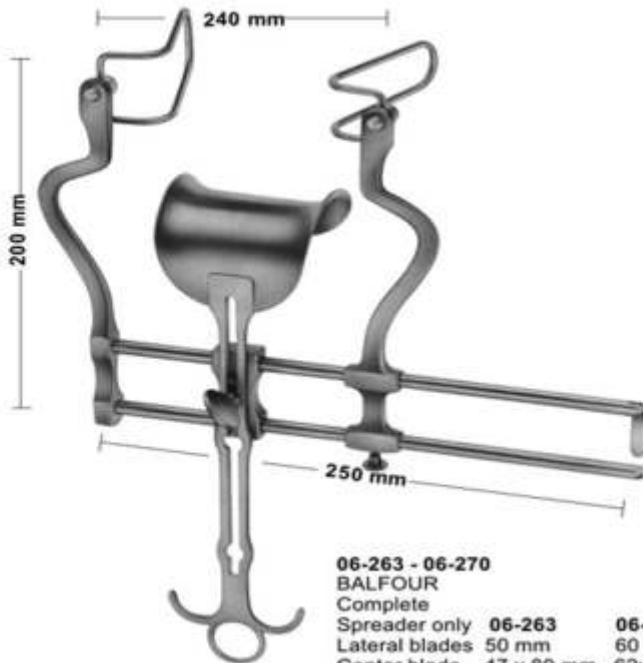

**06-263 - 06-270**  
BALFOUR  
Complete  
Spreader only  
Lateral blades 50 mm 06-263 60 mm 06-264 75 mm 06-265 90 mm 06-266  
Center blade 47 x 80 mm 62x76 mm 80x80 mm 80x80 mm



Lateral blades  
**06-267** 50 mm deep  
**06-268** 60 mm deep  
**06-269** 75 mm deep  
**06-270** 90 mm deep  
Sales Unit of blades: PR = pair

**Organ-, Tissue and Intestinal Grasping Forceps**

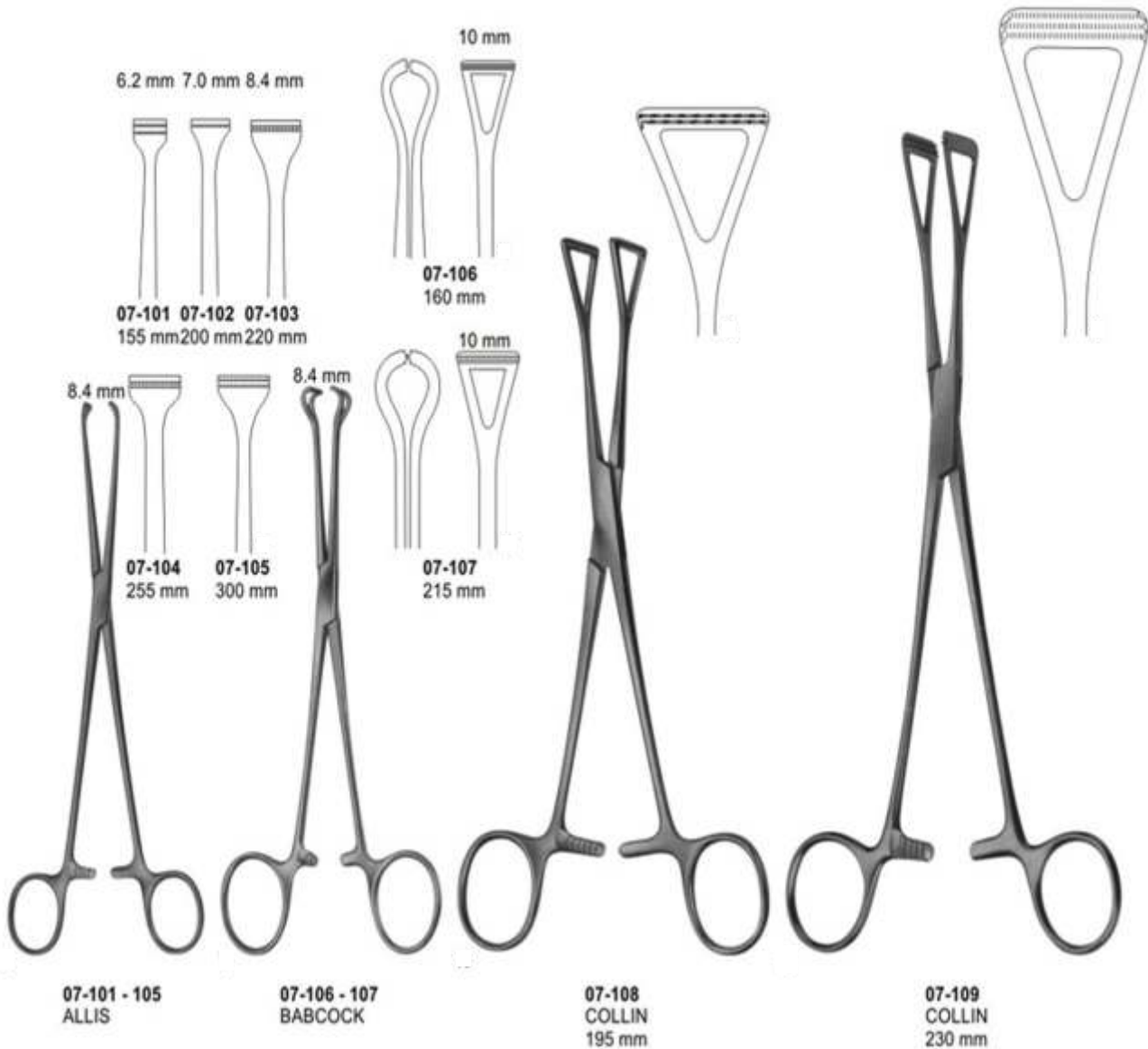

Intestinal Clamps, soft elastic

ATRAUMATA

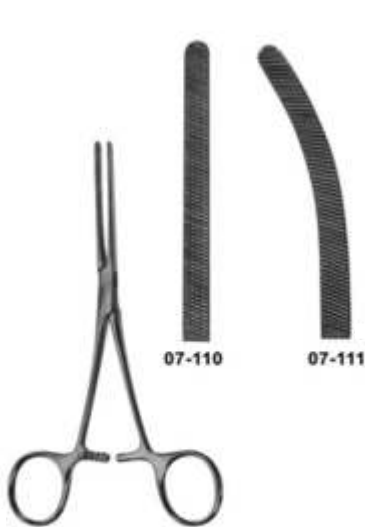

07-110 - 111  
DOYEN  
elastic  
165 mm



07-112 - 113  
DOYEN  
with elastic blades  
170 mm

ATRAUMATA



07-114 - 115  
HARTMANN  
with elastic blades  
200 mm



07-116 - 117  
HARTMANN  
with elastic blades  
200 mm

Intestinal and Pylorus Clamps



**07-118**  
PAYR  
Intestinal clamp  
light pattern,  
for children  
180 mm

**07-119**  
PAYR  
200 mm

**07-120**  
PAYR  
275 mm

**07-121**  
PAYR  
Pylorus clamp  
315 mm

**ATRAUMATA**  
**Sigmoid Anastomosis Forceps**

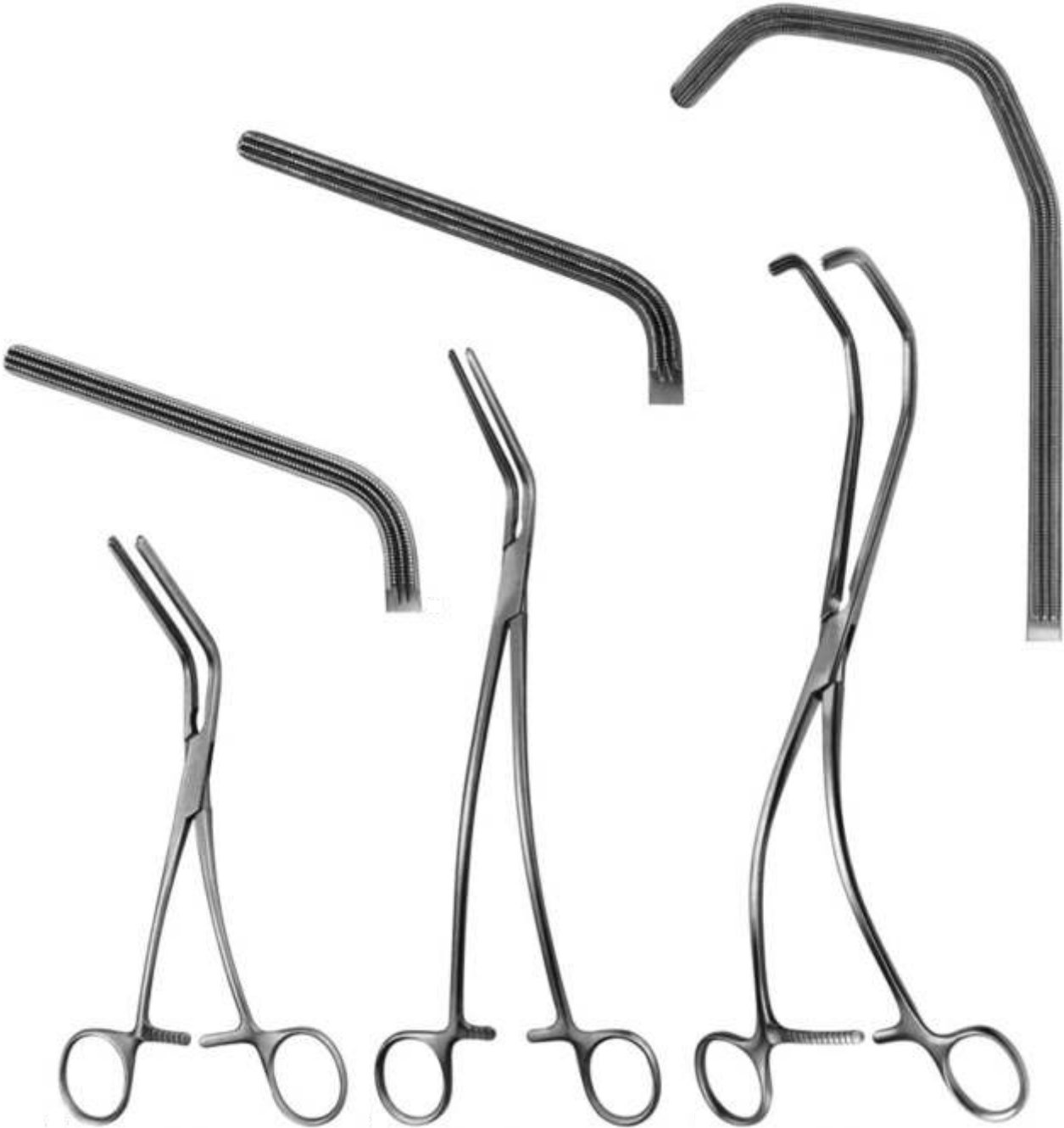

**07-122**  
**MORRIS**  
175 mm

**07-123**  
**DE BAKEY**  
(MORRIS modif.)  
240 mm

**07-124**  
**KERSTING**  
270 mm

Nasal Specula



08-101  
Martin  
13 cm / 5 1/8"



08-102  
SIMS  
160 mm

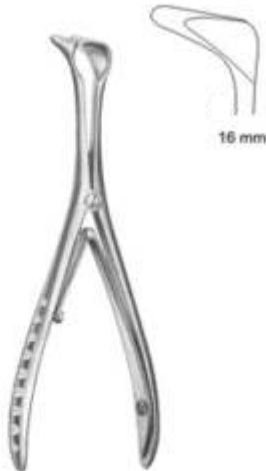

08-103  
Tieck-Hallig  
13 cm / 5 1/8"



08-104  
Killian

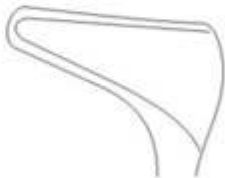

Fig. 1  
14 cm 5 4/8"  
35 mm

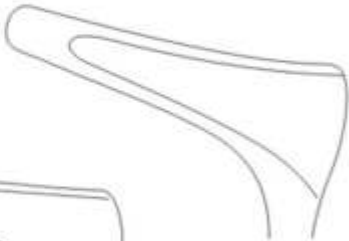

Fig. 2  
14,5 cm / 5 4/8"  
50 mm

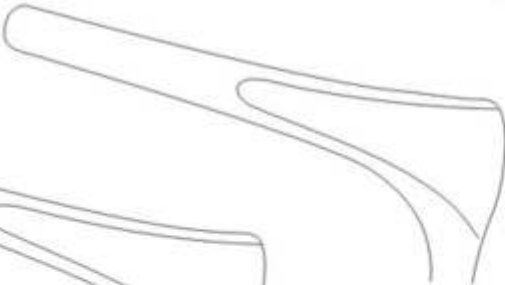

Fig. 3  
16 cm / 6 2/8"  
75 mm

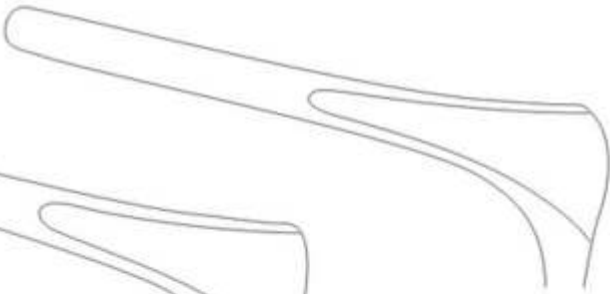

Fig. 4  
17 cm / 6 6/8"  
85 mm

Nasal Specula



08-105  
Cottle

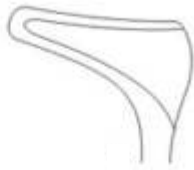

Fig. 1  
13,5 cm / 5 3/8"  
35 mm



Fig. 2  
14 cm / 5 4/8"  
50 mm

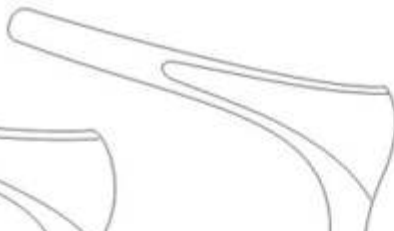

Fig. 3  
16 cm / 6 2/8"  
75 mm

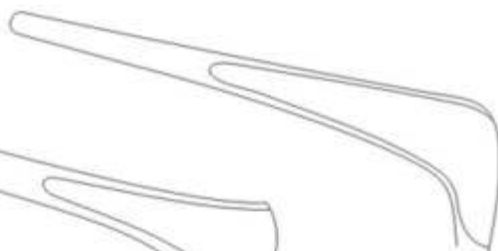

Fig. 4  
16 cm / 6 2/8"  
85 mm



08-106  
Goldsmith (Thudichum)  
6,5 cm / 2 4/8"



Fig. 1  
21,0 x 9,5 mm



Fig. 2  
21,0 x 10,5 mm



Fig. 3  
21,0 x 11,5 mm



08-107  
Mod. Wien 2  
13,5 cm / 5 1/8"



30 mm



08-108  
Hartmann-Halle  
16 cm / 6 1/8"



Fig. 1  
27 mm



Fig. 2  
31 mm



Fig. 3  
35 mm

Anuscopy-Sphincteroscopes



08-109  
IVES-FANSLER  
Anuscopy  
145 mm  
Ø24mm



08-110  
KELLY  
Sphincteroscope  
160 mm  
Ø21mm



08-111  
KELLY  
Sphincteroscope  
160 mm  
Ø27mm

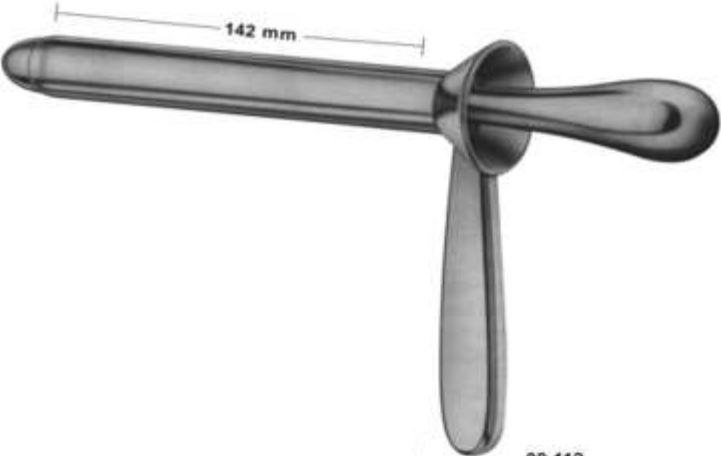

08-112  
KELLY  
Proctoscope  
140 mm  
Ø22mm

Haemorrhoidal Forceps

ATRAUMATA

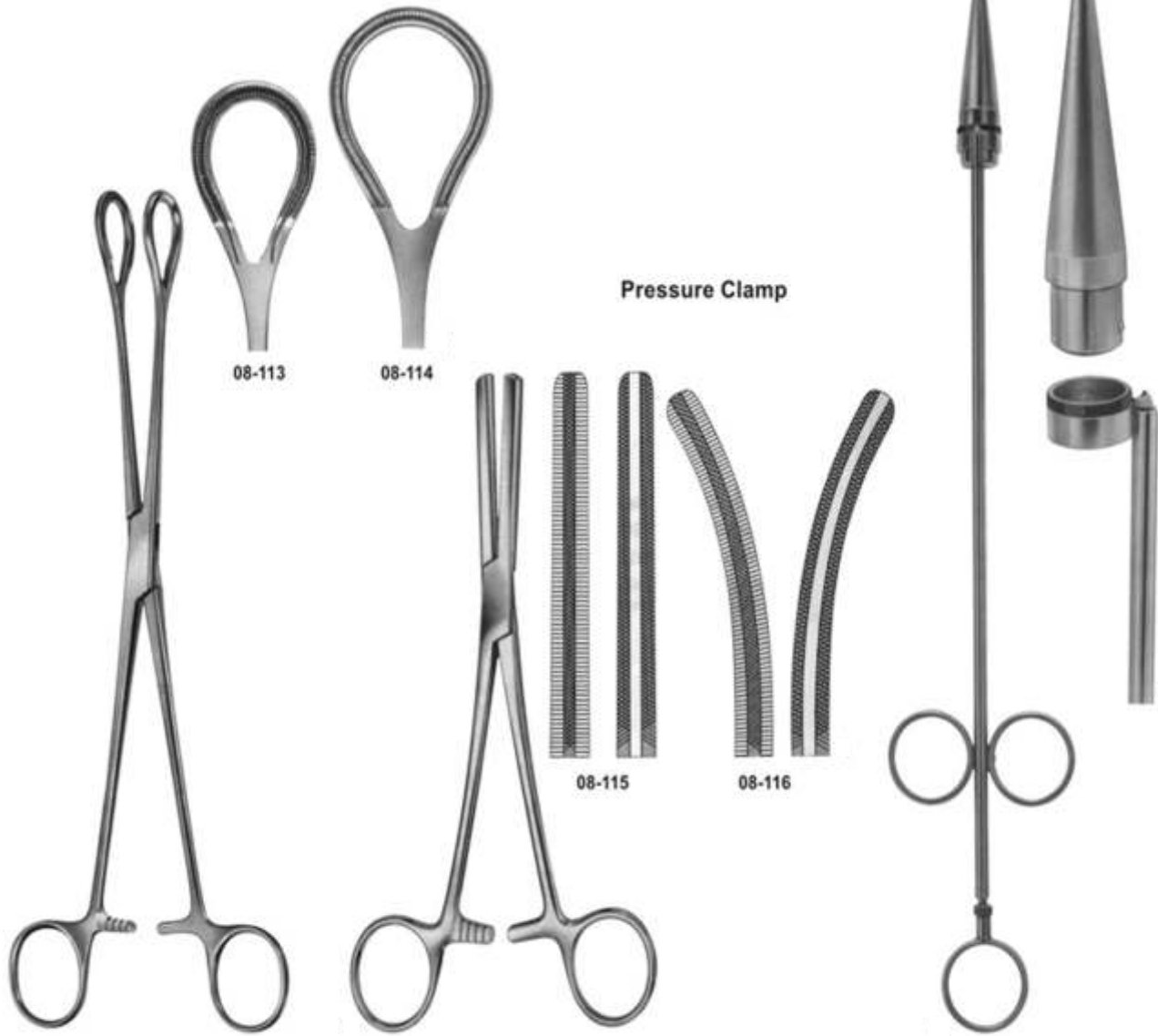

08-113

08-114

Pressure Clamp

08-115

08-116

08-113 - 08-114  
250 mm  
08-114  
270 mm

08-115 - 08-116  
FERGUSSON  
200 mm

08-117  
RUDD  
Haemorrhoidal ligator  
with loading  
attachment and 100  
ligature rubber rings  
315 mm

Gall Duct Forceps



08-118  
LOWER  
180 mm



08-119  
LAHEY ( SWEET )  
190 mm



08-120  
LAHEY  
220 mm



08-121  
DESJARDINS  
Gall duct-and cystic forceps  
210 mm



08-122  
NISSEN  
Gall duct-and cystic forceps  
215 mm

## Gall Duct Dilators and Gall Stone Scoops

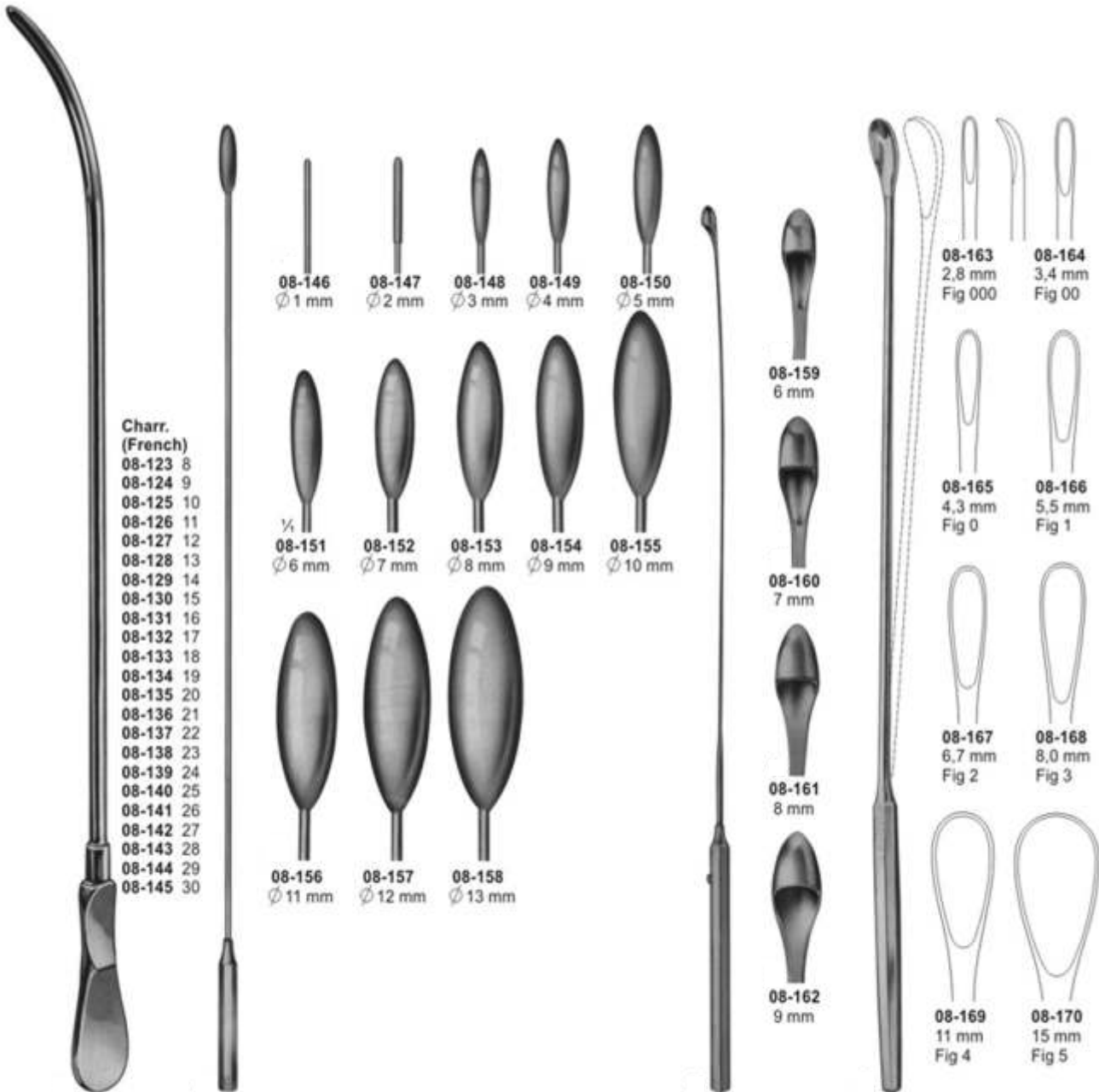

**Charr.  
(French)**  
 08-123 8  
 08-124 9  
 08-125 10  
 08-126 11  
 08-127 12  
 08-128 13  
 08-129 14  
 08-130 15  
 08-131 16  
 08-132 17  
 08-133 18  
 08-134 19  
 08-135 20  
 08-136 21  
 08-137 22  
 08-138 23  
 08-139 24  
 08-140 25  
 08-141 26  
 08-142 27  
 08-143 28  
 08-144 29  
 08-145 30

08-146  
 Ø 1 mm

08-147  
 Ø 2 mm

08-148  
 Ø 3 mm

08-149  
 Ø 4 mm

08-150  
 Ø 5 mm

08-151  
 Ø 6 mm

08-152  
 Ø 7 mm

08-153  
 Ø 8 mm

08-154  
 Ø 9 mm

08-155  
 Ø 10 mm

08-156  
 Ø 11 mm

08-157  
 Ø 12 mm

08-158  
 Ø 13 mm

08-159  
 6 mm

08-160  
 7 mm

08-161  
 8 mm

08-162  
 9 mm

08-163  
 2,8 mm  
 Fig 000

08-164  
 3,4 mm  
 Fig 00

08-165  
 4,3 mm  
 Fig 0

08-166  
 5,5 mm  
 Fig 1

08-167  
 6,7 mm  
 Fig 2

08-168  
 8,0 mm  
 Fig 3

08-169  
 11 mm  
 Fig 4

08-170  
 15 mm  
 Fig 5

**08-123 - 08-145**  
**DITTEL**  
 Metall bougies and  
 dilating sounds, stiff  
 345 mm

**08-146 - 08-158**  
**BAKES**  
 Common bile duct  
 dilators, malleable  
**08-146 - 08-150** 315 mm  
**08-151 - 08-158** 320 mm

**08-159 - 08-162**  
**DESJARDINS**  
 Probe and catch  
 with flexible shaft  
 300 mm

**08-163 - 08-170**  
**LUER-KOERTE modif**  
 with malleable shaft  
 310 mm

Gall Stone Forceps



08-171  
BLAKE  
205 mm



08-172  
BLAKE  
205 mm



08-173  
CZERNY  
245 mm

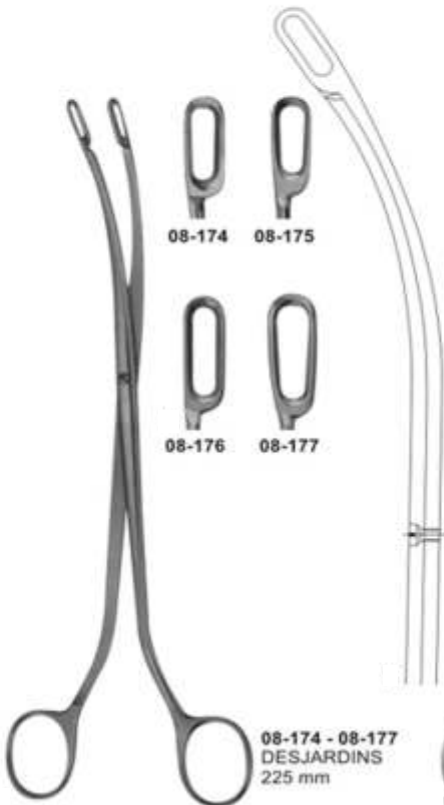

08-174 08-175  
08-176 08-177

08-174 - 08-177  
DESJARDINS  
225 mm

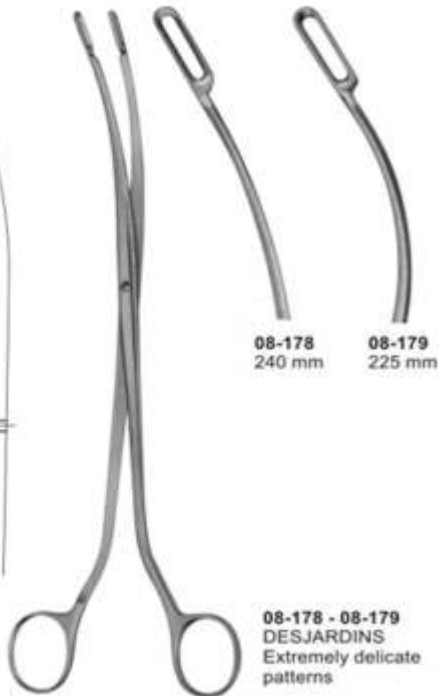

08-178 08-179  
240 mm 225 mm

08-178 - 08-179  
DESJARDINS  
Extremely delicate  
patterns

Kidney Clamps

ASTRUMATA

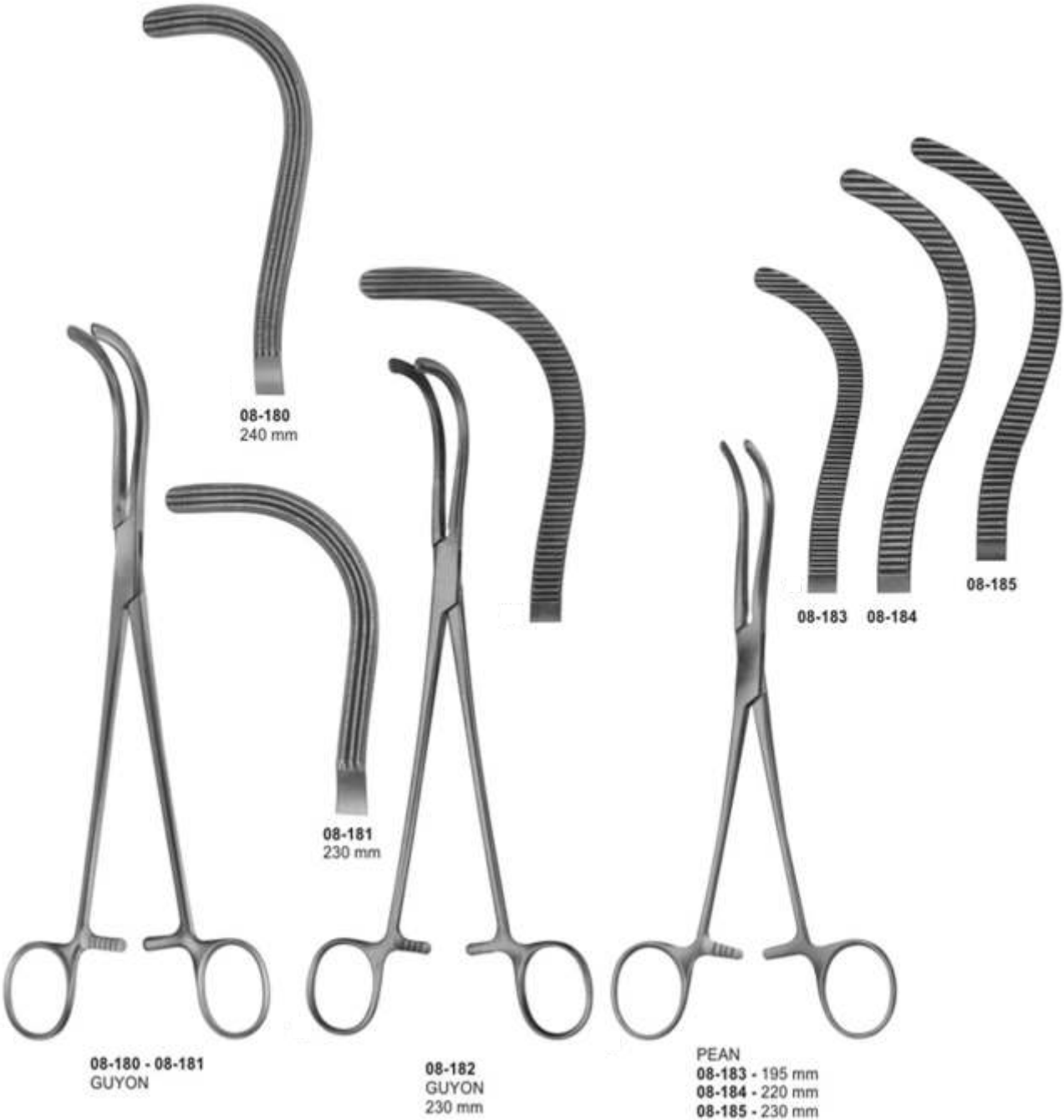

Kidney Stone Forceps



08-186 - 08-189  
RANDALL  
225 mm

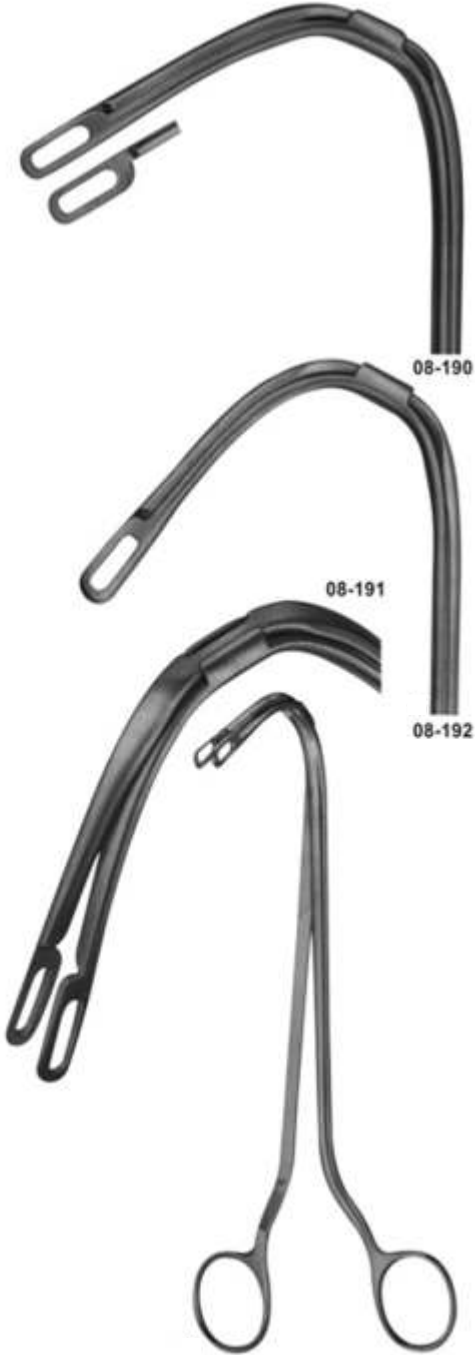

08-190 - 08-192  
RANDALL  
190 mm

Bladder Retractors



**09-101**  
JUDD-MASSON  
Bladder and suprapubic  
retractor



**09-102**  
MILLIN  
Center bladder for  
retro pubic prostatectomy



**09-103**  
MILLIN  
Bladder retractor, complete  
105X45 mm



**09-104**  
LEGUEU  
Bladder retractor  
Center blade  
80 x 31 mm



**09-105**  
KOCHER  
Bladder spatula  
235 mm

## Trocars



**09-106**  
**KLIMA ROSEGGER**  
 35 X 1,8 mm  
 Sternal puncture needle



**09-107**  
 Universal trocar  
 with 4 tips



**NELSON**



**09-113 - 116**  
 Inside dime. Outside dime  
**09-113** 2,2 mm 3,0 mm  
**09-114** 3,0 mm 4,0 mm  
**09-115** 4,0 mm 5,0 mm  
**09-116** 5,0 mm 6,0 mm  
 for abdominal puncture,  
 with stop-cock and lateral  
 drain



**09-117 - 118**  
 Inside diam. Outside diam  
**09-117** 6,5 mm 8,0 mm  
**09-118** 9,0 mm 10,0 mm  
 Empyema trocar  
**BUELEU**



**09-119 - 122**  
 Inside diam. Outside diam  
**09-119** 3,0 mm 4,0 mm  
**09-120** 3,6 mm 4,6 mm  
**09-121** 4,3 mm 5,3 mm  
**09-122** 5,0 mm 6,0 mm  
 Gall bladder trocars. **OCHSNER**



**09-123**  
**PIERCE**  
 Antrum trocar  
 ∅4,0 mm

Record Cone1



**09-124**  
**COAKLEY**  
 Antrum trocar  
 3,0 mm

Luer - Lock  
 Cone

## Vaginal Specula



**10-101**  
COLLIN  
for children  
53 x 10 mm

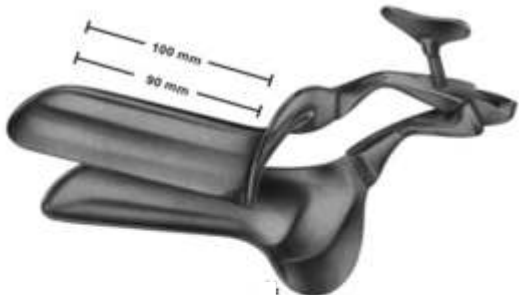

**10-102 - 105**  
COLLIN  

<b>10-102</b>	100/90mm	28 mm
<b>10-103</b>	100/90mm	32 mm
<b>10-104</b>	105/95mm	35 mm
<b>10-105</b>	115/105mm	40 mm

 Total length/working length



**10-106**  
COLLIN  
for virgins  
95/85 x 18 mm



**10-107**  
CUSCO  
for virgins  
75 x 17 mm



**10-108**  
CUSCO  
for virgins  
75 x 17 mm



Swiss patterns  
features: long and narrow

**10-109 - 111**  
CUSCO  

<b>10-109</b>	92X23-25 mm
<b>10-110</b>	100x25-27 mm
<b>10-111</b>	110x27-30 mm

## Vaginal Specula Sets, upper and Lower blades



**10-112 - 114**  
**GRAVE**  
 10-112 75X20 mm  
 10-113 95X30 mm  
 10-114 105X33 mm



**10-115 - 116**  
**PEDERSON**  
 10-115 100X22 mm  
 10-116 120X25 mm



**10-117 - 118**  
**BRIESKY**  
 10-117 72X25 mm / 77X30 mm 140 mm  
 10-118 75X30 mm / 92X38 mm 170 mm



**10-119**  
**SIMS**  
 70 X 26 mm / 75 X 30 mm  
 75 X 30 mm / 80 X 35 mm  
 80 X 36 mm / 90 X 40 mm  
 175 mm



**10-120 - 122**  
**SEIDL**  
 10-120 80X8 mm  
 10-121 80X10 mm  
 10-122 90X14 mm  
 For children and infants  
 170 mm



**10-123**  
**KRISTELLER**  
 70X15 mm, ( 170 mm )  
 For children



**10-124 - 10-126**  
**KRISTELLER**  
 10-124 70X27 mm  
 10-125 75X30 mm  
 10-126 90X36 mm  
 175 mm

Vaginal Specula- upper and Lower blades



10-132 75X10 mm  
175 mm

10-136 70X15 mm  
175 mm

10-133 75X23 mm  
180 mm

10-137 70X27 mm  
180 mm

10-134 80X25 mm  
180 mm

10-138 75X30 mm  
180 mm

10-135 100X32 mm  
185 mm

10-139 90X36 mm  
185 mm

10-127 - 131  
KRISTELLER  
10-127 110X18 mm  
10-128 110X20 mm  
10-129 110X27 mm  
10-130 110X30 mm  
10-131 110X36 mm  
220 mm

10-132 - 10-135  
KRISTELLER  
Upper blades

10-136 - 10-139  
KRISTELLER  
Lower blades

**Vaginal Specula**



Vaginal Retractors



10-154  
JOLL (FRIEDMAN)  
155 mm



10-155  
RICHTER  
170 mm



10-156  
GELPI  
135 mm



10-157  
GELPI  
175 mm

## Uterine Dilators



**11-101 - 143**  
HEGAR  
with very conical point  
185 mm

<b>11-101</b>	1	mm	<b>11-123</b>	23	mm
<b>11-102</b>	2	mm	<b>11-124</b>	24	mm
<b>11-103</b>	3	mm	<b>11-125</b>	25	mm
<b>11-104</b>	4	mm	<b>11-126</b>	26	mm
<b>11-105</b>	5	mm	<b>11-127</b>	1	½mm
<b>11-106</b>	6	mm	<b>11-128</b>	2	½mm
<b>11-107</b>	7	mm	<b>11-129</b>	3	½mm
<b>11-108</b>	8	mm	<b>11-130</b>	4	½mm
<b>11-109</b>	9	mm	<b>11-131</b>	5	½mm
<b>11-110</b>	10	mm	<b>11-132</b>	6	½mm
<b>11-111</b>	11	mm	<b>11-133</b>	7	½mm
<b>11-112</b>	12	mm	<b>11-134</b>	8	½mm
<b>11-113</b>	13	mm	<b>11-135</b>	9	½mm
<b>11-114</b>	14	mm	<b>11-136</b>	10	½mm
<b>11-115</b>	15	mm	<b>11-137</b>	11	½mm
<b>11-116</b>	16	mm	<b>11-138</b>	12	½mm
<b>11-117</b>	17	mm	<b>11-139</b>	13	½mm
<b>11-118</b>	18	mm	<b>11-140</b>	14	½mm
<b>11-119</b>	19	mm	<b>11-141</b>	15	½mm
<b>11-120</b>	20	mm	<b>11-142</b>	16	½mm
<b>11-121</b>	21	mm	<b>11-143</b>	17	½mm
<b>11-122</b>	22	mm			



**11-144 - 152**  
HEGAR  
205 mm

<b>11-144</b>	1+2	mm
<b>11-145</b>	3+4	mm
<b>11-146</b>	5+6	mm
<b>11-147</b>	7+8	mm
<b>11-148</b>	9+10	mm
<b>11-149</b>	11+12	mm
<b>11-150</b>	13+14	mm
<b>11-151</b>	15+16	mm
<b>11-152</b>	17+18	mm



**11-153**  
HEGAR  
Uterine dilator set, in canvas  
roll with 8 dilators.

Uterine Probes

5 mm



11-154  
MAYO  
malleable  
330 mm

4 mm



11-155  
SIMS  
malleable  
330 mm

3 mm



11-156  
MARTIN  
330 mm

4 mm



11-157  
SIMPSON  
malleable  
silver-plated  
290 mm



24 mm

11-158  
BRAUN  
Uterine  
depressor  
270 mm



11-159  
Cotton  
applicator  
270 mm

Uterine Dressing Forceps



11-160  
PELKMANN  
260 mm



11-161  
PELKMANN  
260 mm



11-162  
BOZEMANN  
250 mm

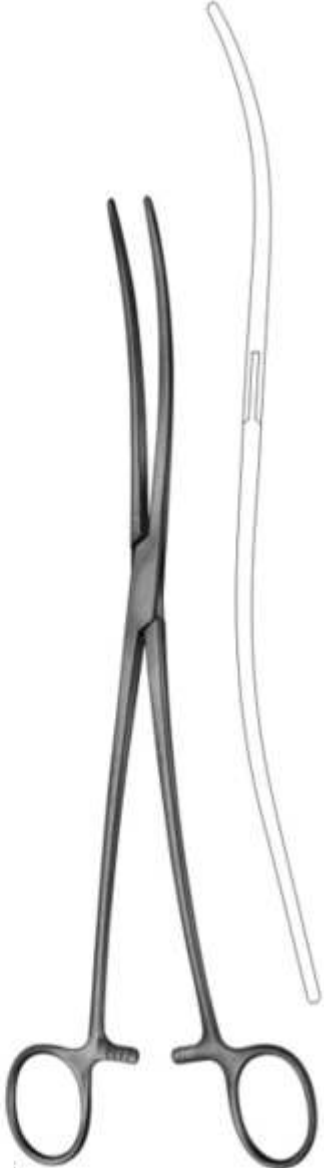

11-163  
BOZEMANN  
255 mm

Jaws with longitudinal groove

Polypus-and Ovum Forceps



11-164  
HEYWOOD-SMITH  
200 mm

11-165  
KELLY  
320 mm

11-166  
HEYWOOD-SMITH  
250 mm

11-167  
NOTO  
280 mm

Ear Curettes



**12-101**  
Langenbeck  
13 cm / 5 1/8"

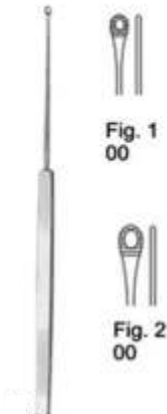

**12-102**  
Shapleigh  
15 cm / 5 1/8"

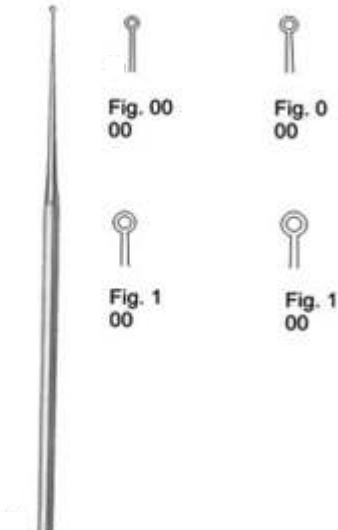

**12-103**  
Buck  
17cm / 6 6/8"



**12-104**  
Buck  
15 cm / 6 6/8

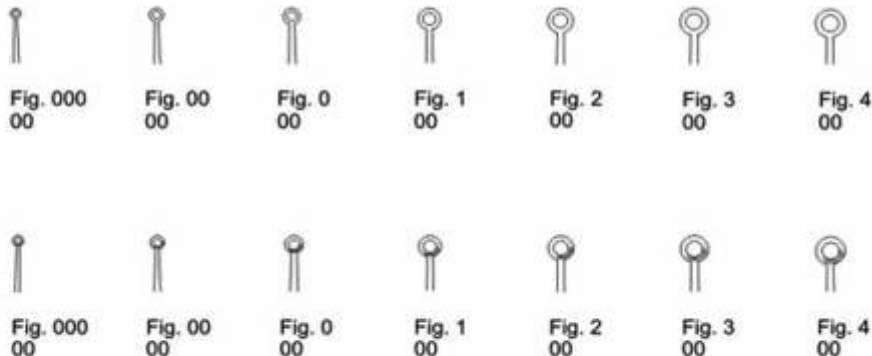

Biopsy Currettes



12-105  
ASCH  
Uterine  
Secretion scoop  
200 mm



12-106  
Uterine  
Secretion scoop  
270 mm



12-107  
NOVAK-SCHOECKAERT  
Endometrial biopsy  
curette  
240 mm



12-108  
RANDALL  
Endometrial  
biopsy curette  
240 mm

Ear Polypus Forceps



12-109  
Hartmann-Wullstein  
shaft length  
85 mm



12-110  
Hartmann-Wullstein  
shaft length  
85 mm



12-111  
Hartmann  
shaft length  
85 mm



12-112  
Hartmann  
shaft length  
85 mm



12-109 - 12-119

12-113  
14 cm / 5 4/8"  
shaft length  
140 mm

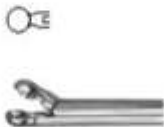

12-114  
Hartmann-Herzfeil  
2,0 mm  
shaft length  
85mm



12-115  
Hartmann  
3 mm  
shaft length  
85mm



12-116  
shaft length  
85mm



12-117  
Hartmann-Hoffmar  
2,0 mm  
85mm

12-118  
2,5 mm  
85 mm

12-119  
3,0 mm  
85 mm

Biopsy forceps for rectum

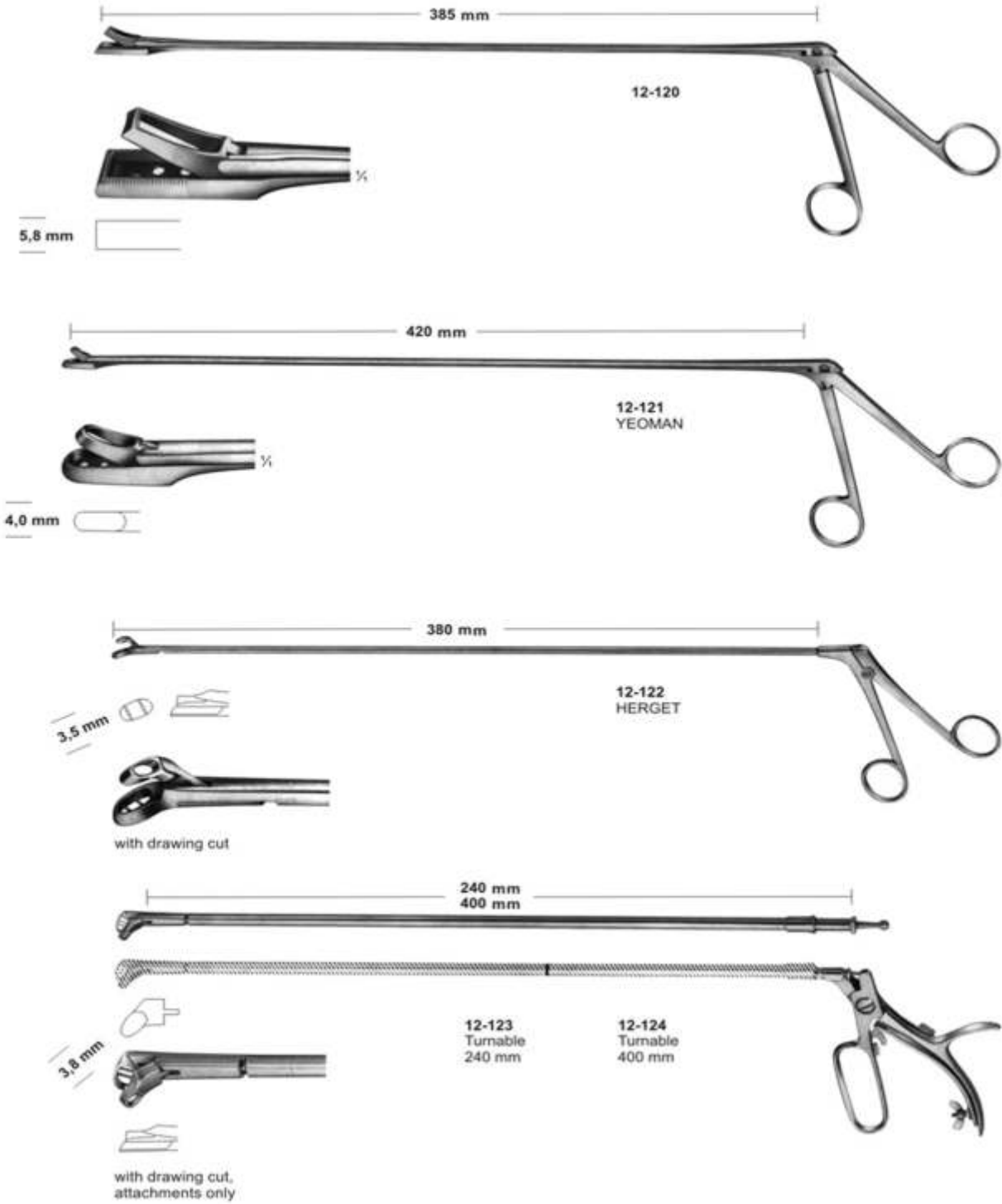

Biopsy Forceps

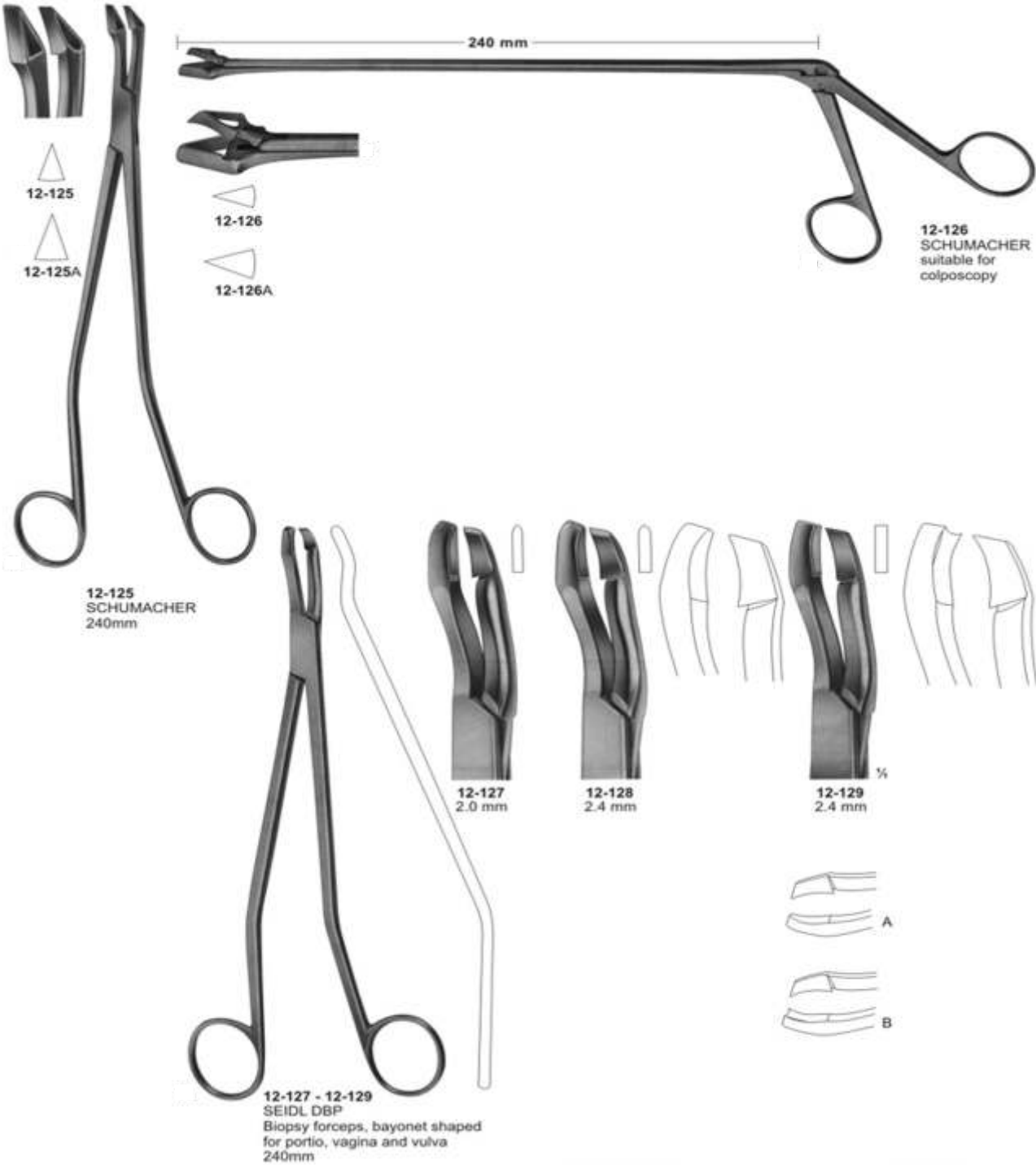

Biopsy Forceps

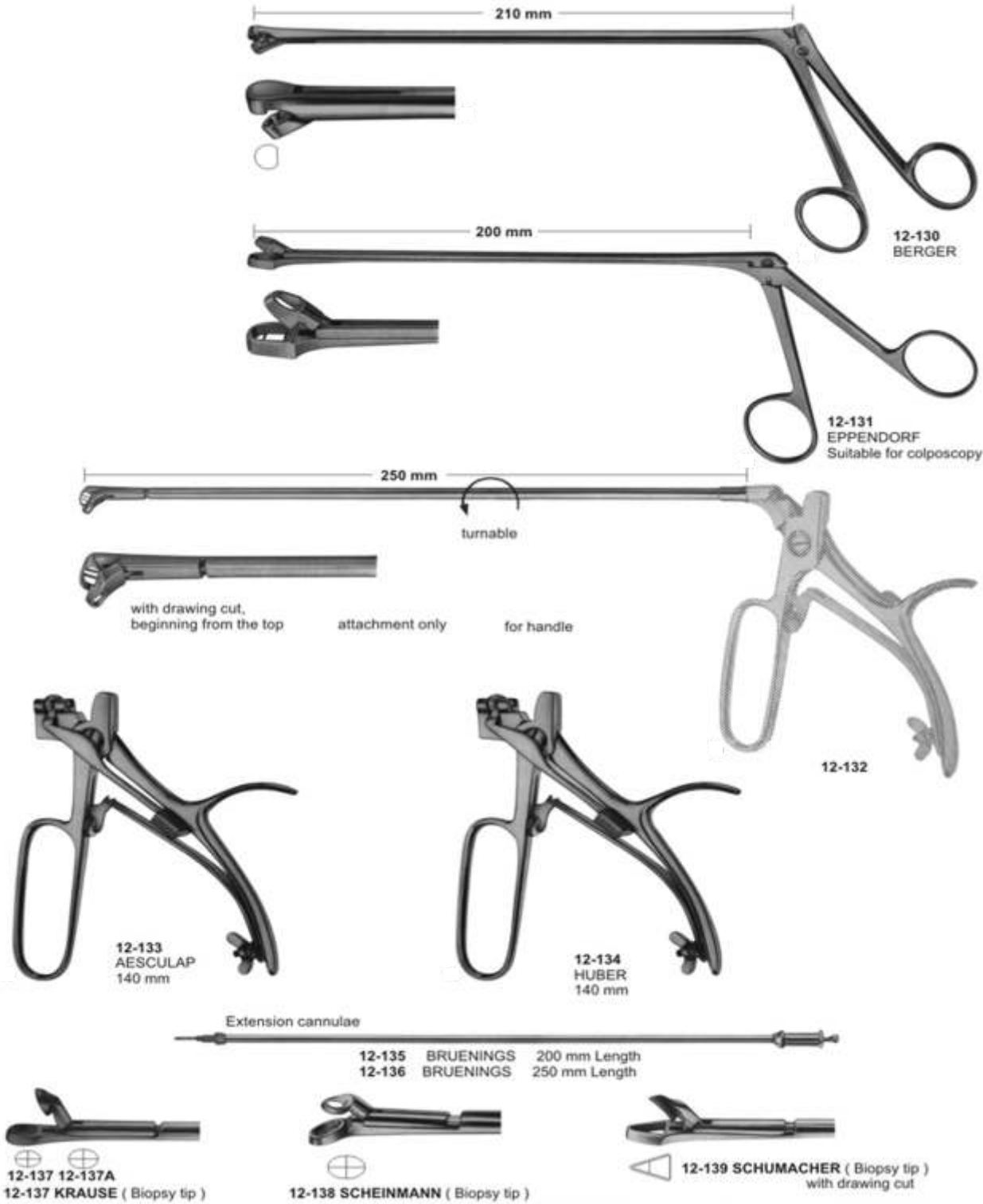

Uterine Scoops



12-140  
SIMON  
240 mm

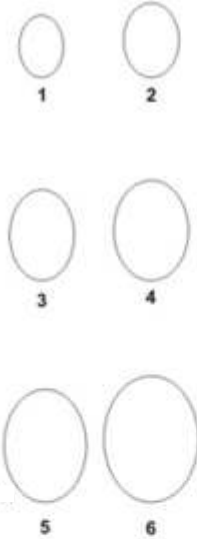

12-141  
SCHROEDER  
310 mm

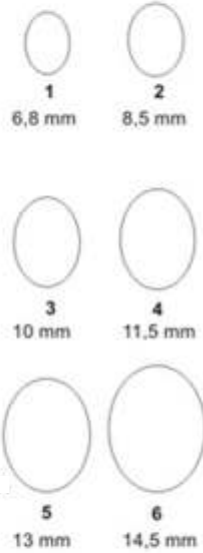

12-142  
RECAMIER  
300 mm

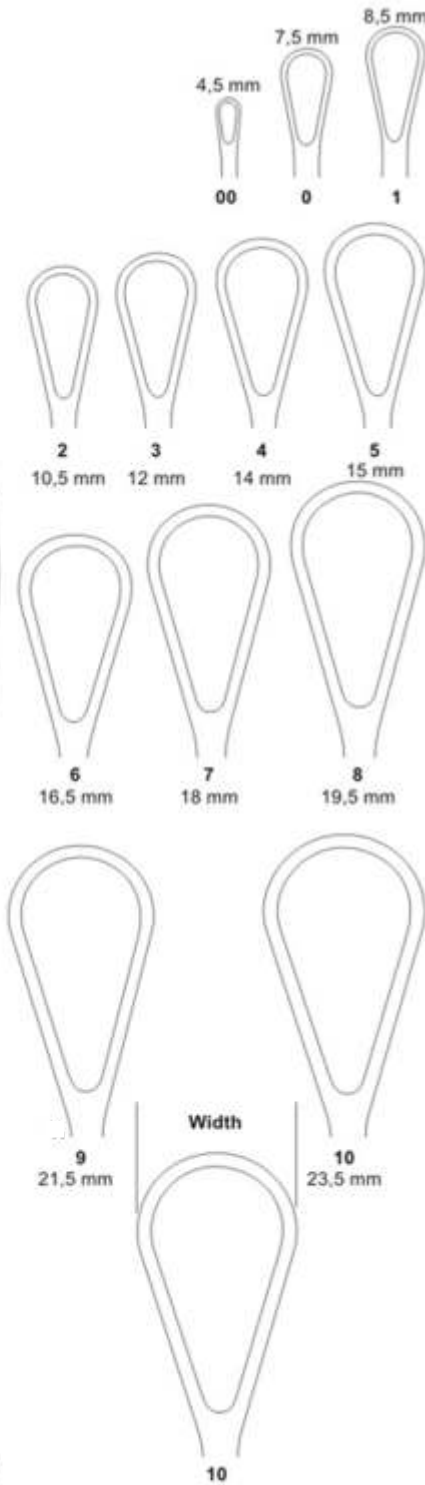

Obstetrical Forceps



13-101  
NAEGELE  
355 mm



13-102  
NAEGELE  
400 mm



13-103  
SIMPSON-BRAUN  
305mm

Obstetrical- Placenta and Ovum Forceps

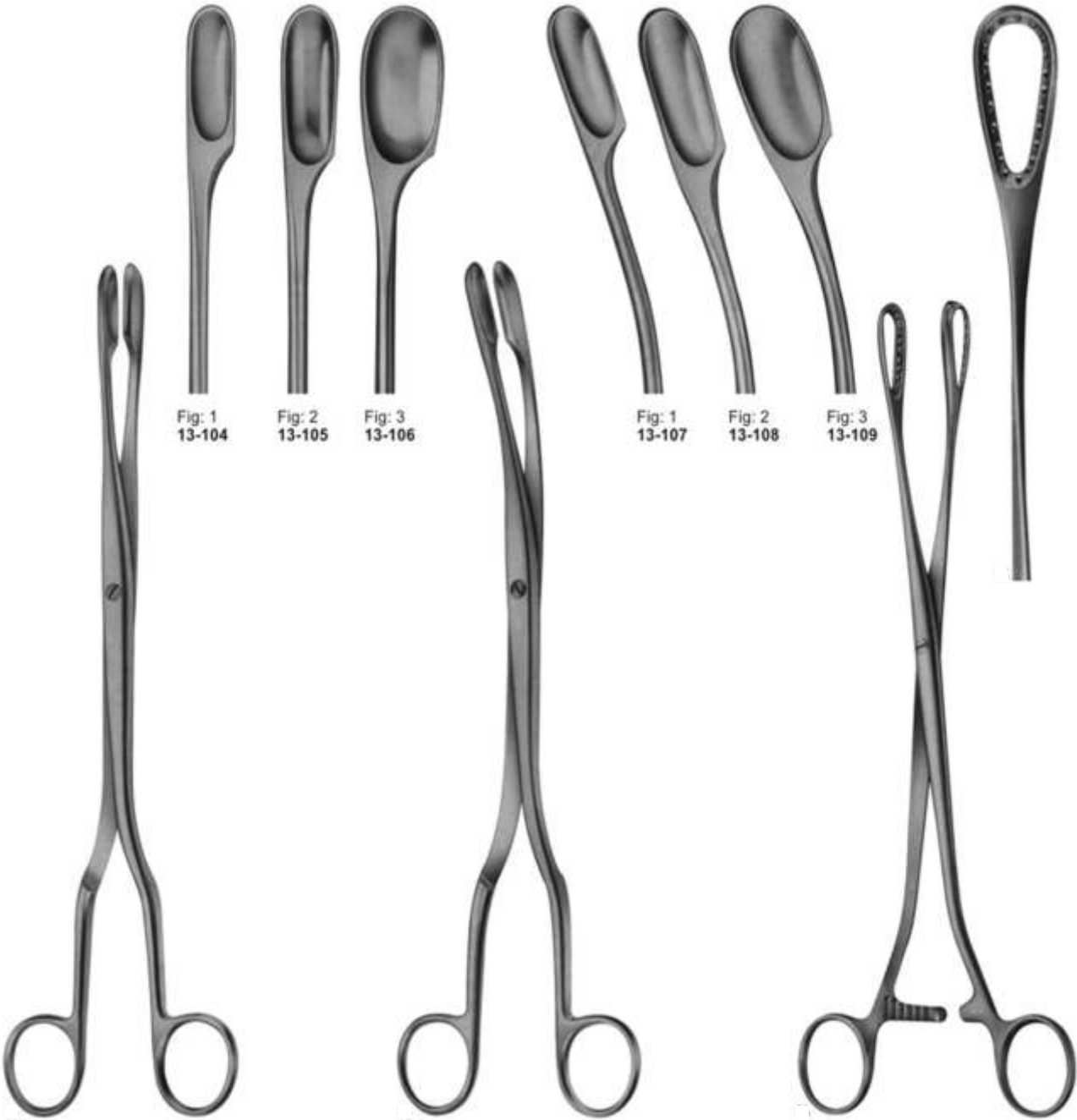

13-104 - 106  
WINTER  
290 mm

13-107 - 109  
WINTER  
290 mm

13-110  
SAENGER  
275 mm

Tound- and Tracheal Hooks and Dilators



13-111  
BOSE  
165 mm



13-112  
BOSE  
165 mm



13-113  
sharp



13-114  
blunt



13-115  
stumpf/blunt

13-113 - 115  
180 mm



13-116  
FINSEN  
50 mm



13-117  
FINSEN  
70 mm



13-118  
TROUSSEAU  
120 mm



13-119  
LABORDE  
125 mm



13-120  
LABORDE  
strong pattern  
135 mm



13-121  
Cleaning Brush  
for tracheal tubes  
285 mm

Vascular Spatulas

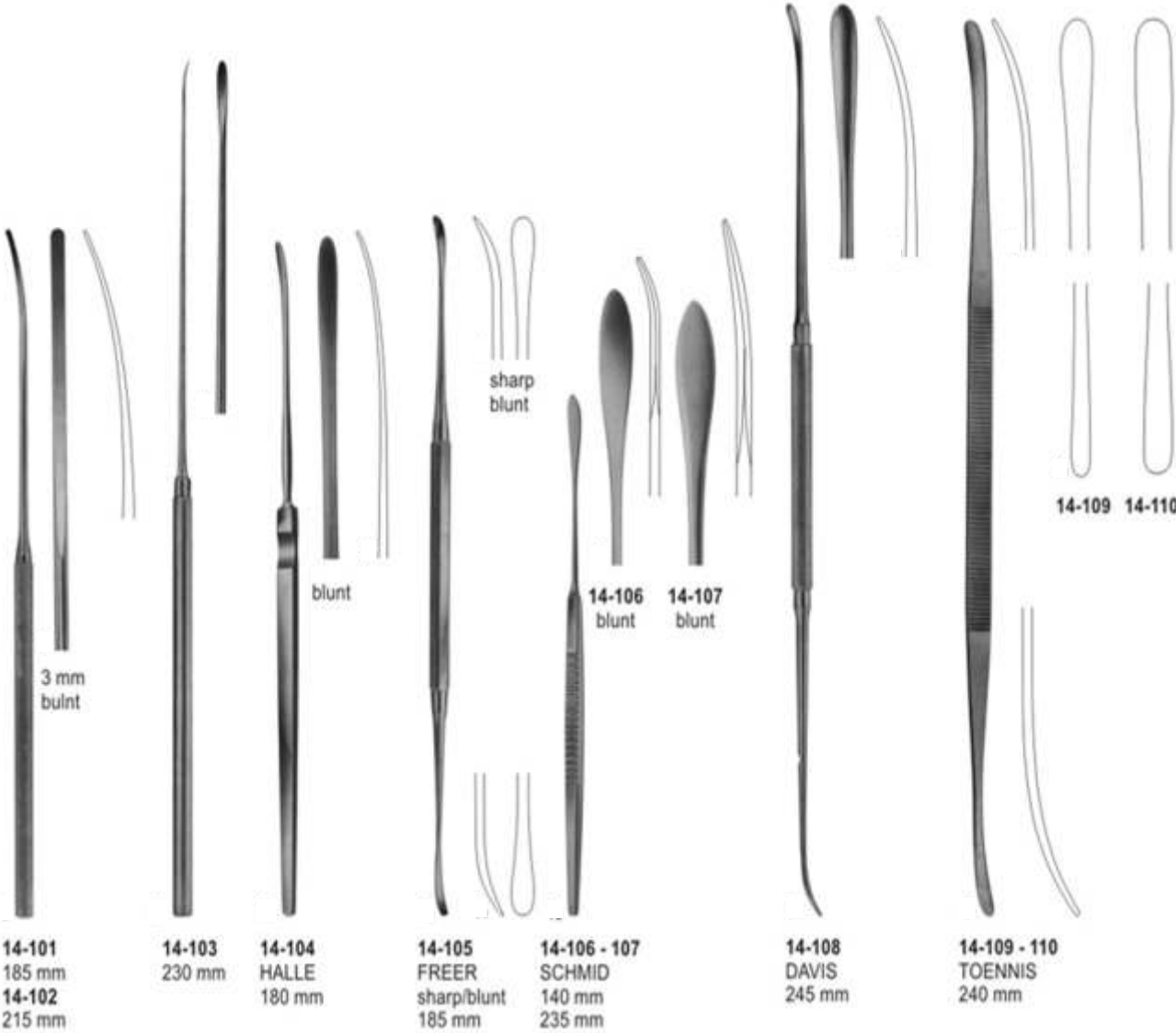

**ATRUMATA**  
**Forceps**



**14-111**  
1,5 mm

**14-112**  
1,5 mm

**14-111 - 112**  
DE BAKEY  
150 mm  
200 mm



**14-113**  
2 mm  
150 mm

**14-114**  
2 mm  
200 mm

**14-115**  
2 mm  
240 mm

**14-116**  
2 mm  
300 mm

**14-113 - 116**  
DE BAKEY



**14-117**  
2,8 mm  
150 mm

**14-118**  
2,8 mm  
200 mm

**14-119**  
2,8 mm  
240 mm

**14-120**  
2,8 mm  
300 mm

**14-117 - 120**  
DE BAKEY



**14-121**  
3,3mm  
200 mm

**14-122**  
3,5 mm  
300 mm

**14-123**  
3,5 mm  
240 mm

**14-121 - 123**  
DE BAKEY



**14-124**  
2 mm  
40°

**14-124**  
DE BAKEY  
150 mm



**14-125**  
2 mm  
40°

**14-125**  
DE BAKEY  
200 mm

ATRAUMATA

Anastomosis- and Multi- Purpose- Clamps- Pediatric Types

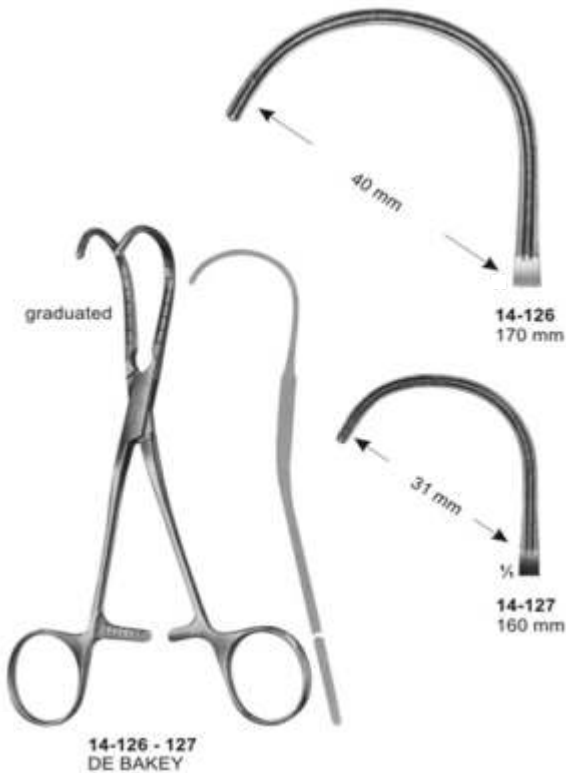

**ATRAUMATA**

**Coarctation Clamps, Patent-Ductus & Peripheral-Vascular Clamps**



**14-135 - 137**  
DE BAKEY



<b>14-135</b>	<b>14-136</b>	<b>14-137</b>
41 mm	65 mm	80 mm
205 mm	225 mm	240 mm



**14-138 - 140**  
DE BAKEY



<b>14-138</b>	<b>14-139</b>	<b>14-140</b>
41 mm	65 mm	80 mm
200 mm	225 mm	240 mm



**14-141**  
DE BAKEY  
210 mm



51 mm



**14-142**  
DE BAKEY  
210 mm



15°  
51 mm



**14-143**  
DE BAKEY  
160 mm



56 mm

Aorta- Anastomosis Clamps



L  
14-144  
WEBER  
260 mm

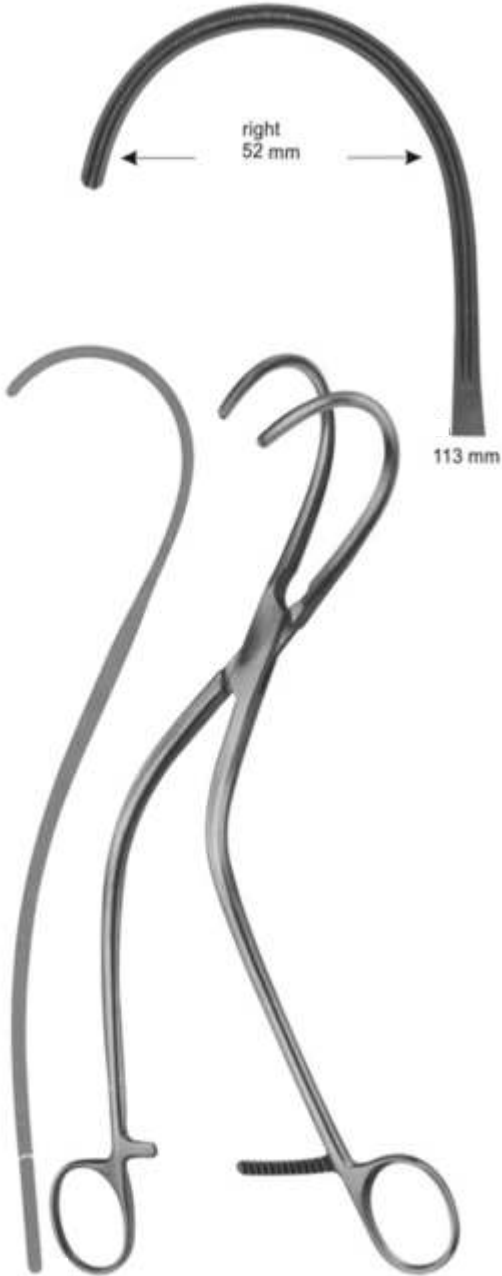

R  
14-145  
WEBER  
260 mm

Multi- Purpose-Clamps



14-146 - 149  
DE BAKEY

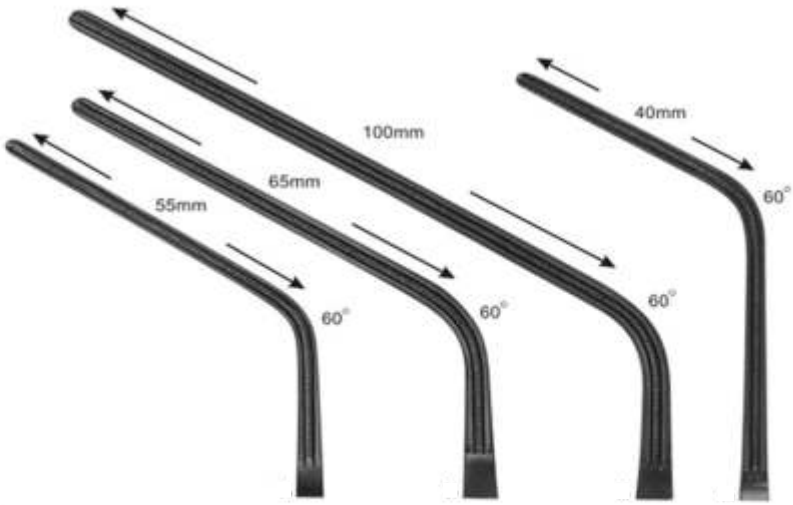

14-146      14-147      14-148      14-149

Total Length:	230 mm	280 mm	305 mm	240 mm
Length of jaws:	85 mm	100 mm	135 mm	93 mm



14-150 - 153  
DE BAKEY

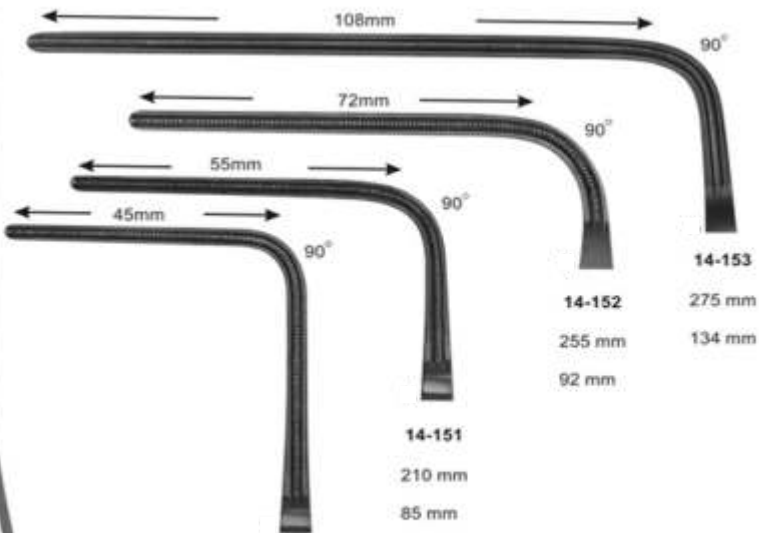

14-150      14-151      14-152      14-153

Total Length:	225 mm	210 mm	255 mm	275 mm
Length of jaws:	93 mm	85 mm	92 mm	134 mm

Sternum Instruments and Rib Shears



14-154  
SCHUMACHER  
Sternum shears  
210 mm



14-155  
LEBSCHKE  
Sternum chisel  
200 mm



14-156  
230 mm



14-157  
COLLIN  
195 mm



14-158  
GLUCK  
190 mm



14-159  
BETHUNE  
340 mm



14-160  
BRUNNER  
Universal pattern  
340 mm



14-161  
GIERTZ-STILLE  
250 mm

Rib Spreaders



14-162  
FINOCHIETTO  
Blades  
18X21 mm



14-163  
HERTZLER  
Blades  
20X25 mm

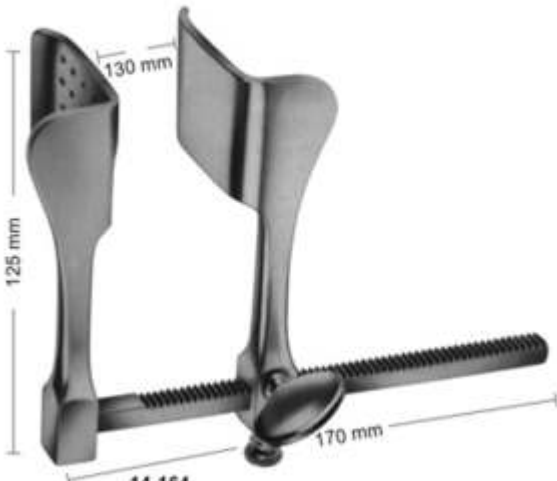

14-164  
TUFFIER  
Blades  
43X53 mm

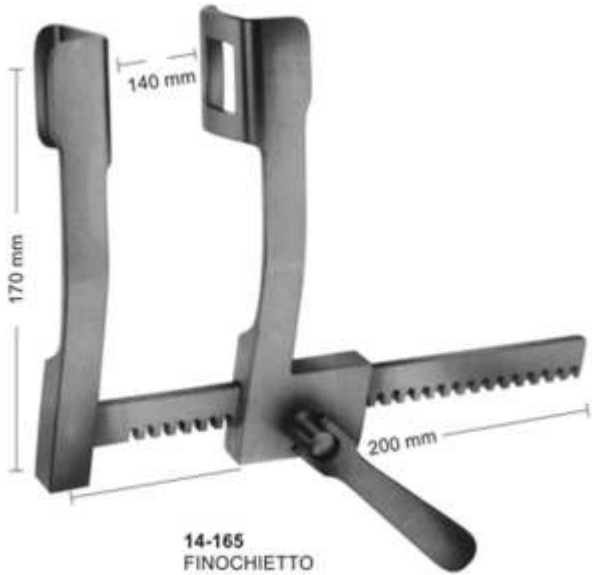

14-165  
FINOCHIETTO  
Blades  
36X45 mm

Rib Spreaders-and Contractors



**14-166**  
**SELLORS**  
Rib spreader-and contractor  
with swivel blades  
200 mm



**14-167**  
**BAILEY**  
150 mm



**14-168**  
for children

**14-169**  
for adults

**14-168 - 169**  
**BAILEY**  
200 mm

Punches

130°

upwards cutting

15-101  
1 mm



KERRISON - JACOBY

FERRIS-SMITH-KERRISON

15-102  
2 mm



15-103  
3 mm



15-104  
4 mm



15-105  
5 mm

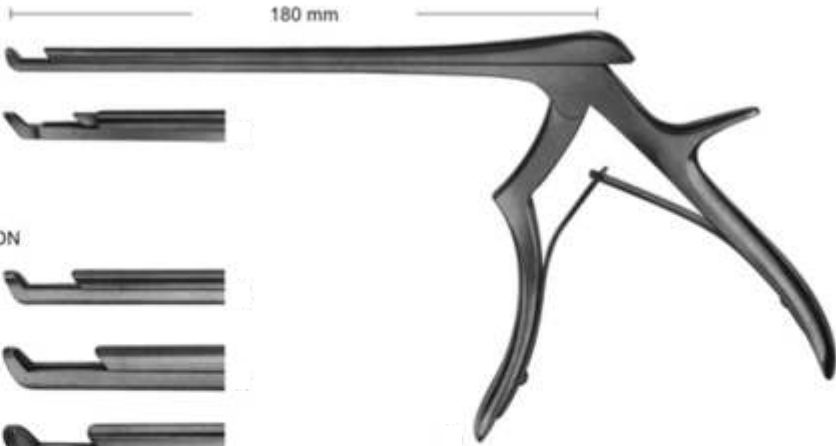

15-101 - 105

90°

upwards cutting

KERRISON - JACOBY

15-106  
1 mm



15-107  
2 mm



FERRIS-SMITH-KERRISON

15-108  
3 mm



15-109  
4 mm



15-110  
5 mm

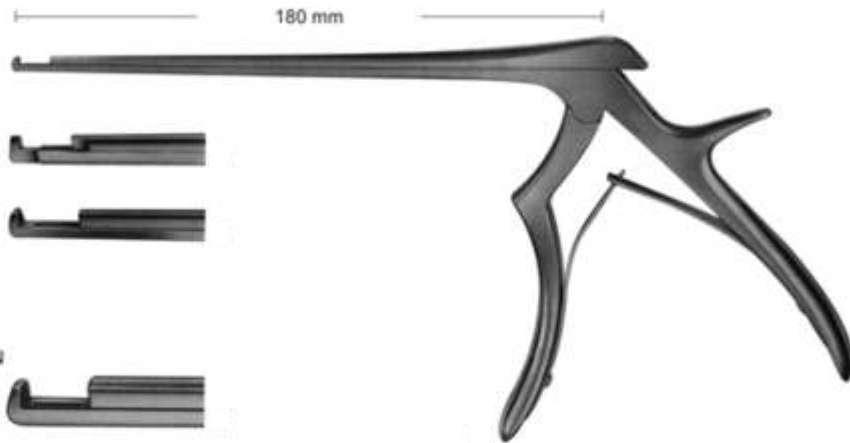

15-106 - 110

Punches

90° upwards cutting



15-111  
4 mm



15-112  
5 mm



15-111 - 15-112  
KERRISON

90° upwards cutting

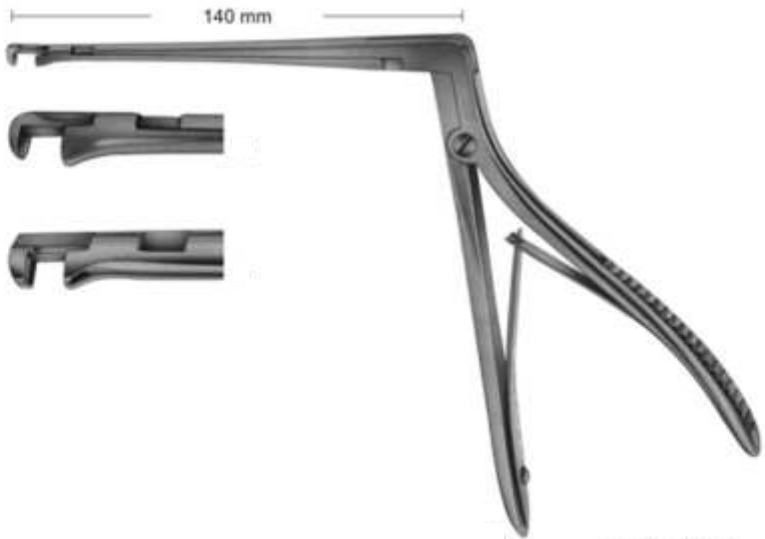

15-113  
3,3 mm



15-114  
4,0 mm



15-113 - 15-114  
HAJEK-KOFLER

Rongeurs

LOVE-GRUENWALD

15-115  
2 X 10 mm

15-116  
3 X 10 mm

SPURLING  
15-117  
4 X 10 mm



15-115 - 15-117

15-118  
2 mm

15-119  
3 mm

15-120  
4 mm

15-121  
5 mm

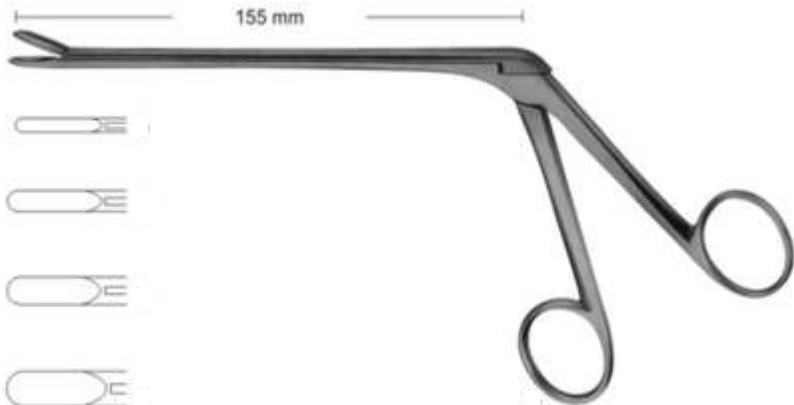

15-118 - 15-121  
CASPAR

150°

15-122  
2 mm

15-123  
3 mm

15-124  
4 mm



15-122 - 15-124  
CASPAR

Rongeurs

Angled positions for rongeurs

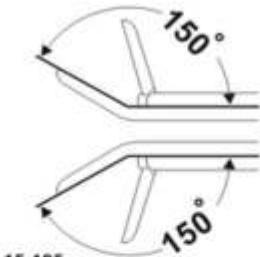

15-125  
3,0 mm

15-126  
3,6 mm

15-127  
4,2 mm

15-128  
4,8 mm

15-129  
5,8 mm

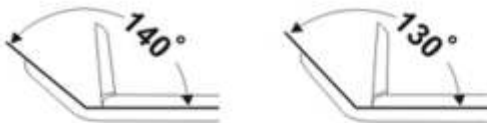

130°



## Rongeurs

**150°**

Lower part of jaws movable

15-132  
2 mm

15-133  
3 mm

15-134  
4 mm



15-132 - 15-134  
CASPAR

Length of shaft 140 mm	Length of shaft 160 mm	Length of shaft 185 mm	size of jaws
15-135	15-140	15-145	2 X12 mm
15-136	15-141	15-146	3 X12 mm
15-137	15-142	15-147	4 X14 mm
15-138	15-143	15-148	5 X14 mm
15-139	15-144	15-149	6 X16 mm



15-135 - 15-149  
CASPAR

**150°**

Length of shaft 140 mm	Length of shaft 160 mm	Length of shaft 185 mm	size of jaws
15-150	15-153	15-156	3 X12 mm
15-151	15-154	15-157	4 X14 mm
15-152	15-155	15-158	5 X14 mm



15-150 - 15-158  
CASPAR

Rongeurs

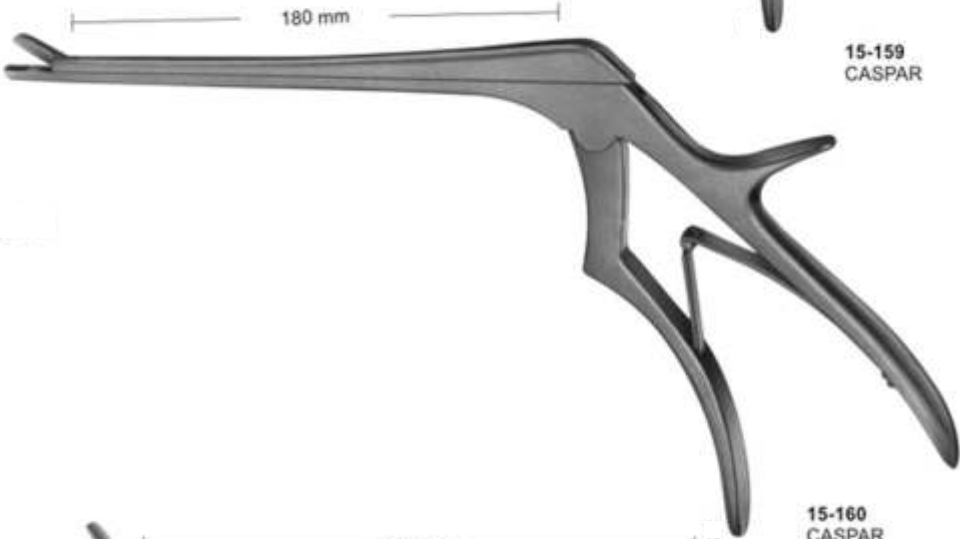
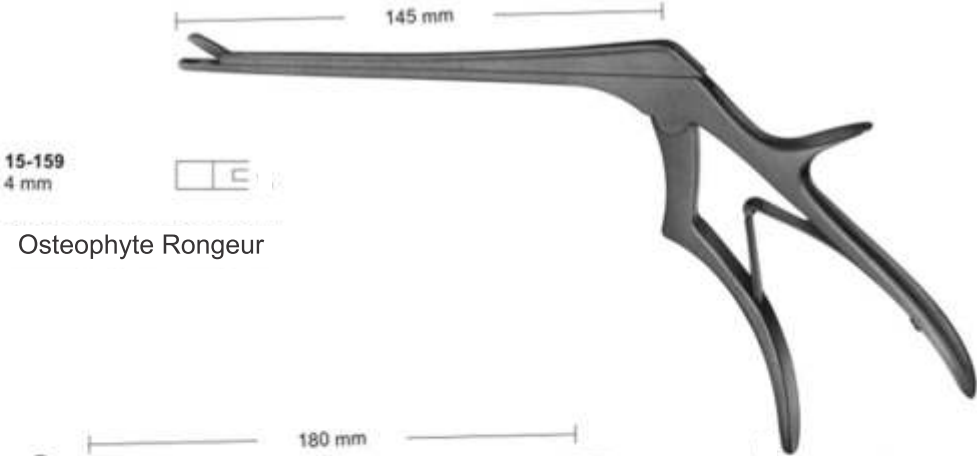

Elevators and Bone Levers



16-101 - 102  
KONIG  
155 mm

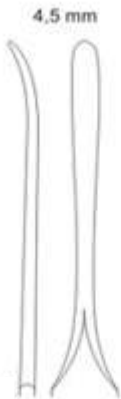

4.5 mm

16-101

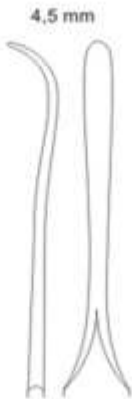

4,5 mm

16-102



16-103  
WILLIGER  
165 mm



5 mm

16-103



16-104  
WILLIGER  
170 mm



5,5 mm

16-104



16-105  
QUERVAIN  
195 mm

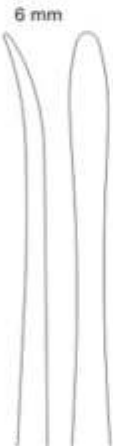

6 mm



16-106 - 107  
LANGENBACK  
195 mm



8 mm

16-106



10 mm

20-107



16-108  
LANGENBACK  
230mm

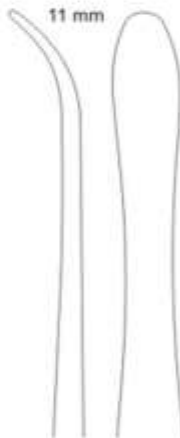

11 mm

Bone Levers



16-109  
LANE TRETOWAN  
215mm



16-110  
LANE  
255mm



16-111  
LANGE-HOHMANN  
250mm

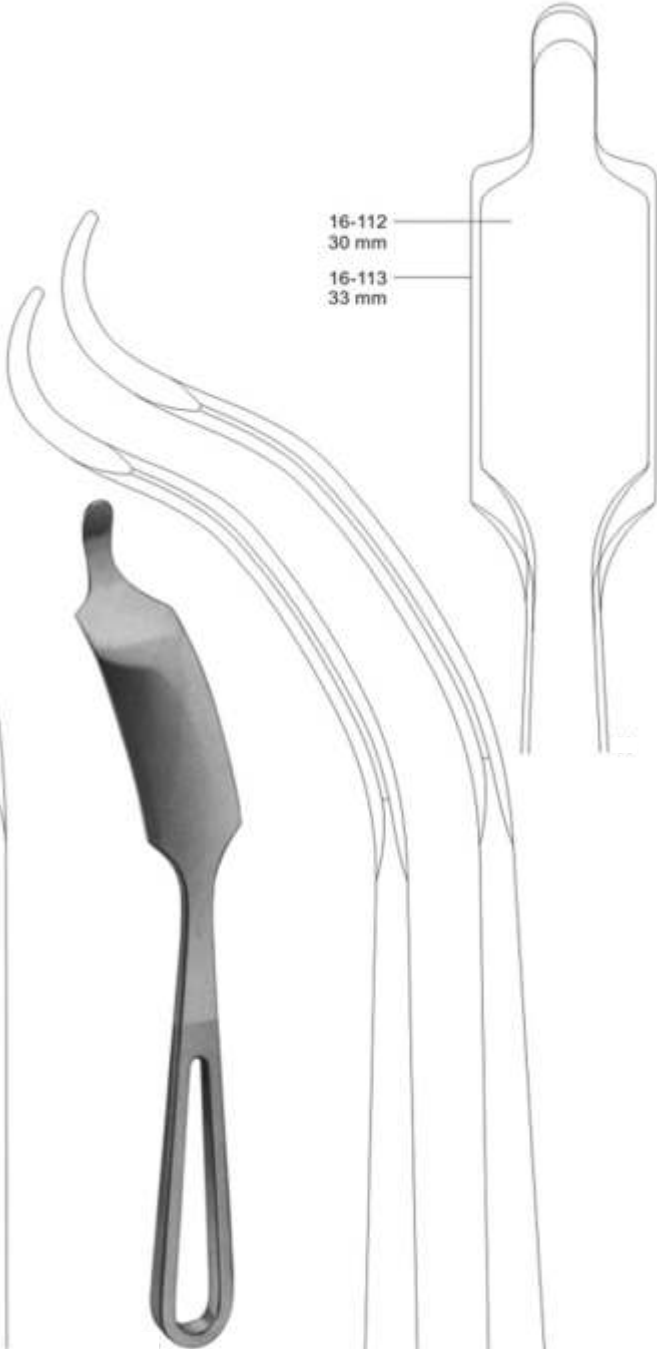

16-112  
30 mm  
16-113  
33 mm

16-112 - 113  
LANGE-HOHMANN modif.  
16-112 265mm  
16-113 280mm

Raspatories



16-114  
PARTSCH  
150 mm



16-116  
PARTSCH mod. LANGE  
145 mm



16-117  
MC KENTY  
155 mm



16-118  
KOENIG  
155 mm



16-119  
TRELAT  
150 mm



16-120  
WILLIGER  
140 mm



16-121  
WILLIGER  
160 mm



16-122  
JOSEPH  
170 mm

Bone File ans Raps

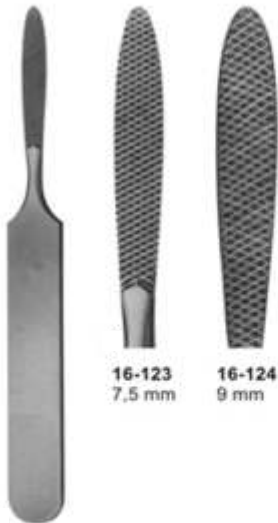

16-123  
7,5 mm

16-124  
9 mm

16-123  
JOSEPH  
fine, chequered

16-124  
coarse, chequered  
165 mm

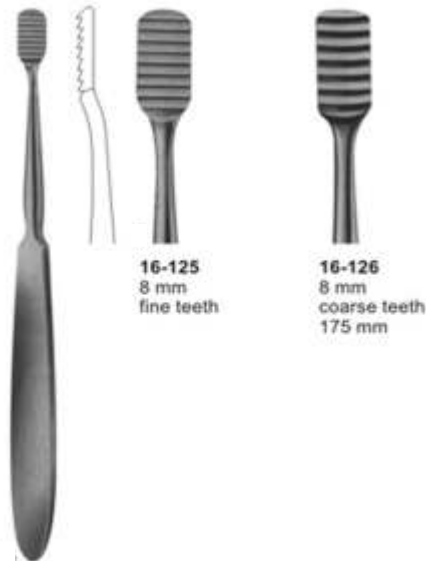

16-125  
8 mm  
fine teeth

16-126  
8 mm  
coarse teeth  
175 mm

16-125 - 16-126  
LEWIS



9 mm

16-127  
MALTZ  
down stroke  
180 mm

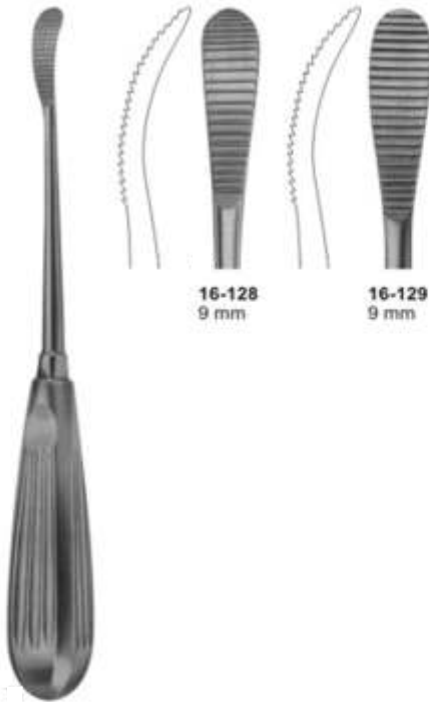

16-128  
9 mm

16-129  
9 mm

16-128 - 16-129  
AUFRICHT  
up stroke  
16-129  
down stroke  
220 mm



6,5 mm

16-130  
GALLAHER  
190 mm

Bone Currettes



16-131  
JACOBSON  
140 mm



16-132  
MARTINI  
140 mm



16-133  
MARTINI  
140 mm



16-134  
WILLIGER  
145 mm



16-135  
JANSEN  
160 mm



16-136  
BARTH  
180 mm



16-137  
VOLKMANN  
130 mm



16-138  
VOLKMANN  
145 mm



16-139  
VOLKMANN  
170 mm

**Mallets** Weights refer to the heads of the mallets

**Hammers** Die Gewichtsangaben beziehen sich auf den Kopf des jeweiligen Hammers



∅ 20 mm

**17-101**  
**MEAD**  
185 g  
with interchangeable  
plastic disks  
190 mm  
**17-102**  
pair of spare disks



∅ 25 mm

**17-103**  
140 g  
with interchangeable  
plastic disks  
185 mm  
**17-104**  
pair of spare disks



∅ 30 mm

**17-105**  
**COTTLE**  
140 g  
1 Side Flat  
1 Side convex  
185 mm



∅ 22 mm

**17-106**  
165 g  
lead filled head  
190 mm

## Osteotomes, Chisels and gouges



**17-107**  
**MANNERFELT**  
Gouge  
155 mm

3 mm



**17-108 - 112**  
Osteotomes  
140 mm

- 17-108 4 mm
- 17-109 6 mm
- 17-110 8 mm
- 17-111 10 mm
- 17-112 12 mm



**17-113 - 117**  
Chisels  
140 mm

- 17-113 4 mm
- 17-114 6 mm
- 17-115 8 mm
- 17-116 10 mm
- 17-117 12 mm



**17-118 - 122**  
Gouges  
140 mm

- 17-118 4 mm
- 17-119 6 mm
- 17-120 8 mm
- 17-121 10 mm
- 17-122 12 mm



**PARTSCH**  
**17-123 - 126**  
Chisels  
140 mm

- 17-123 3 mm
- 17-124 4 mm
- 17-125 5 mm
- 17-126 6 mm



**PARTSCH**  
**17-127 - 131**  
Chisels  
170 mm

- 17-127 3 mm
- 17-128 4 mm
- 17-129 5 mm
- 17-130 6 mm
- 17-131 7 mm



**PARTSCH**  
**17-132 - 135**  
Gouges  
140 mm

- 17-132 3 mm
- 17-133 4 mm
- 17-134 5 mm
- 17-135 6 mm



**PARTSCH**  
**17-136 - 140**  
Gouges  
170 mm

- 17-136 3 mm
- 17-137 4 mm
- 17-138 5 mm
- 17-139 6 mm
- 17-140 7 mm



**LUCAS**  
**17-141 - 142**  
Chisels  
160 mm

- 17-141 4 mm
- 17-142 6 mm



**LUCAS**  
**17-143 - 144**  
Gouges  
160 mm

- 17-143 3 mm
- 17-144 5 mm

Reposition Forceps, Bone Holding Forceps



17-145  
Patella forceps  
185 mm



17-146  
Forceps with  
ratchet fixation  
140 mm



17-147  
Forceps with  
thread fixation  
170 mm



17-148  
Forceps with  
thread fixation  
235 mm



17-149  
DINGMANN  
185 mm

Bone Holding Forceps & Bone Clamps



17-150  
KERN-LANE  
240 mm



17-151  
LANE  
330 mm



17-152  
KERN-LANE  
240 mm



17-153



17-154 - 155  
LOWMAN  
17-154 170 mm  
17-155 205 mm



17-156  
LOWMAN-GERSTER  
210 mm



17-157  
LOWMAN-HOGLUND  
175 mm

Bone Rongeurs



17-158  
LUER  
150 mm



17-159  
LUER  
155 mm



17-160  
BLUMENTHAL  
155 mm



17-161  
BLUMENTHAL  
150 mm



17-162 - 163  
JANSEN  
175 mm



17-164  
BANE-HARTMANN  
175 mm

Bone Rongeurs



17-165  
STILLE  
235 mm



17-166  
LEKSELL-STILLE  
240mm



17-167  
STILLE-RUSKIN  
240mm

Bone Cutting Forceps



17-168  
LISTON  
curved on flat  
240 mm



17-169  
LISTON  
straight  
280 mm



17-170  
LISTON  
curved on flat  
280 mm

## Wire Extension

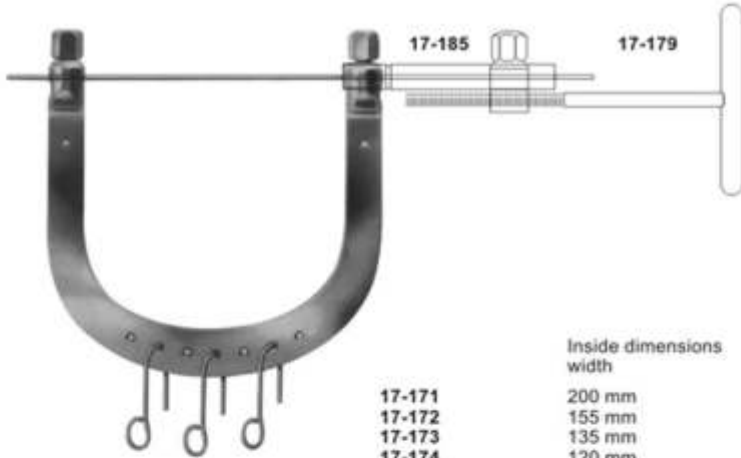

**17-171 - 17-177**  
**KIRSCHNER**  
 Wire traction bows,  
 to be used with  
**KIRSCHNER**-wires  
 up to 2.5 mm diam.,  
 With 3 hooks,  
 stainless steel

	Inside dimensions width	depth	
<b>17-171</b>	200 mm	155 mm	for the hip
<b>17-172</b>	155 mm	155 mm	for the femur
<b>17-173</b>	135 mm	130 mm	for the knee
<b>17-174</b>	120 mm	120 mm	for the knee
<b>17-175</b>	105 mm	100 mm	for the knee
<b>17-176</b>	95 mm	110 mm	for the calcaneus
<b>17-177</b>	95 mm	70 mm	for the arm and elbow



**17-178**  
 Wrench, double - ended,  
 for wire traction bows



**17-179**  
 Wire tightener, with  
 clamping jaws



<b>17-182</b>	max. 105 mm
<b>17-183</b>	max. 160 mm
<b>17-184</b>	max. 200 mm
<b>17-182</b>	80-95 mm
<b>17-183</b>	90-120 mm
<b>17-184</b>	140-170 mm
diam upto	
<b>17-182</b>	1,6 mm
<b>17-183</b>	2,0 mm
<b>17-184</b>	2,5 mm

**17-182 - 17-184**  
**KIRSCHNER**  
 Wire traction bows, modified,  
 adjustable in width, holds wire  
 securely, with 1 hook



**17-180**  
 Traction hook only,  
 large size



**17-181**  
 Traction hook only,  
 small size



**17-185**  
 Fixation clamp, to secure clamping  
 jaws of **17-179** stainless steel

Cerclage Instruments

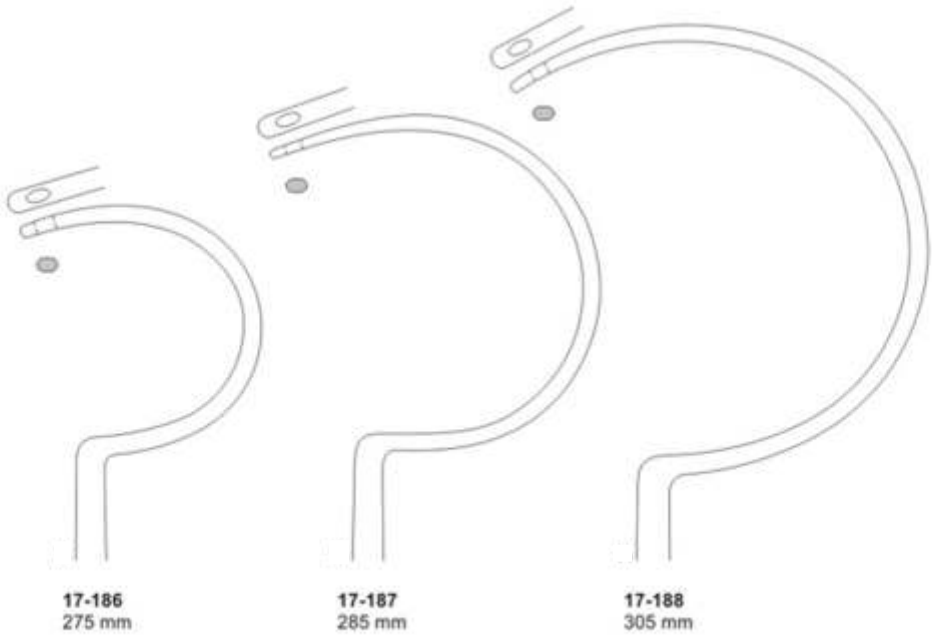

17-186 - 17-188  
DEMEL  
Wire guides

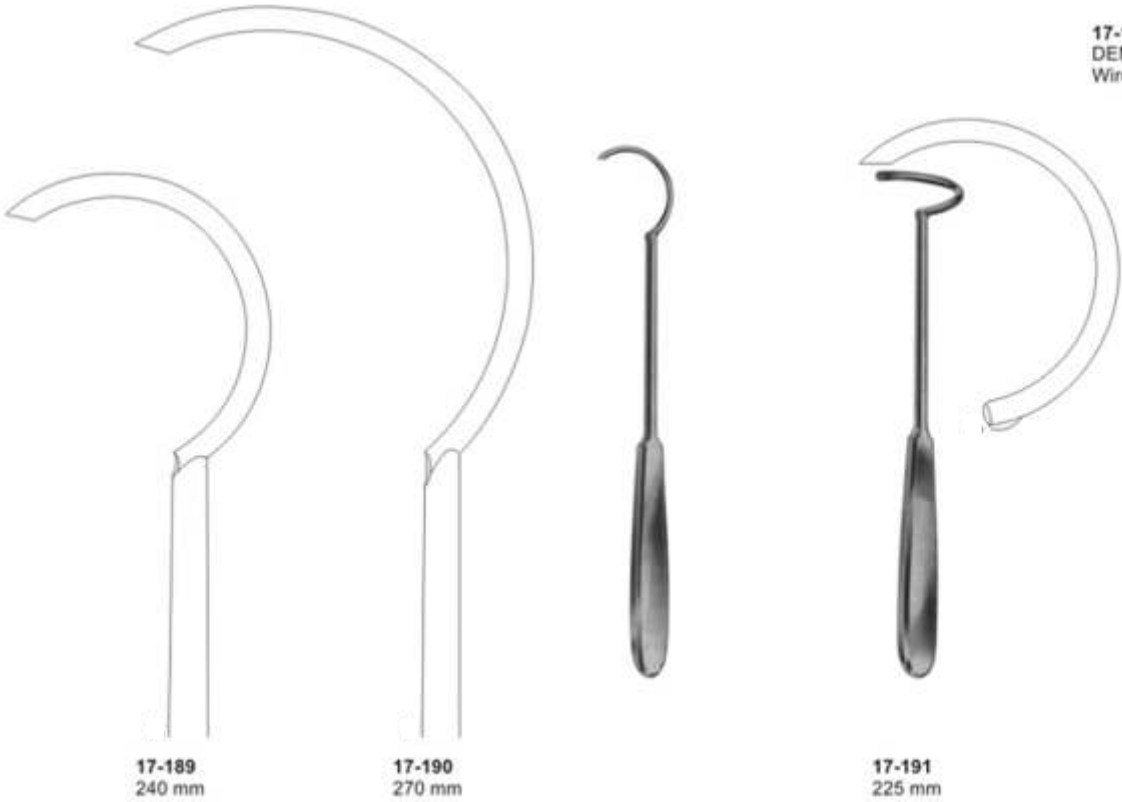

Wire Holding forceps, Wire Tightening Pliers, Flat-Nosed Pliers DUROGRIP with Hard Matel Inserts



**17-192**  
DUROGRIP  
Holding forceps for cerclage wire, with lateral jaws to avoid wire slipping off  
170 mm



**17-193**  
DUROGRIP  
Wire, tightening pliers, Ligature pliers  
150 mm



**17-194**  
DUROGRIP  
Wire, tightening pliers, Ligature pliers  
150 mm



**17-195**  
with serrated jaws  
140 mm



**17-196**  
one jaw smooth, one jaw serrated  
140 mm



**17-197**  
with serrated jaws  
**17-198**  
with longitudinal and transversal grooves  
170 mm



**17-199**  
190 mm

**Wire Holding forceps, Flat-nosed Pliers,  
Pliers for bending and cutting wires**



**17-200**  
130 mm

**17-201**  
180 mm



**17-200 - 17-201**  
Extraction pliers  
for boring wires



**17-202**  
Flat-nosed pliers,  
parallel  
185 mm



**17-203**  
Vise grip  
200 mm



**17-204**  
Round Pliers  
180mm



**17-204**



**17-204**



**17-205**



**17-206**



**17-207**

**17-205** 145 mm  
**17-206** 180 mm  
**17-207** 180 mm  
Extraction pliers for wires

**17-204 - 17-207**



**17-208**  
Bending pliers  
for wires up to  
1.8 mm diam.

**Wire Cutters and wire Cutting Scissors  
DUROTIP with Carbide Cutting Edges**



**17-209**  
ANGLE  
130 mm

**17-210**  
DUROTIP  
ANGLE  
130 mm

for soft wire  
up to diam.  
for hard wire  
up to diam.

0,5 mm  
0,3 mm

0,6 mm  
0,4 mm

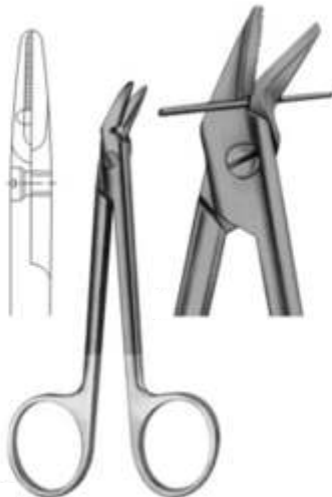

**17-211**  
120 mm

**17-212**  
DUROTIP  
120 mm

for soft wire  
up to diam.  
for hard wire  
up to diam.

1,2 mm  
0,8 mm

1,2 mm  
0,8 mm



**17-213**  
HARVEY  
125 mm

0,4 mm  
0,3 mm



**17-214**  
150 mm

for soft wire  
up to diam.  
for hard wire  
up to diam.

1,5 mm  
1,0 mm



**17-215**  
160 mm

1,5 mm  
1,2 mm



**17-216**  
140 mm  
DUROTIP  
1,5 mm

1,0 mm

Wire Cutting, Lateral Cutting Action



17-217  
180 mm

for soft wire  
up to diam. 2,0 mm  
For hard wire 1,5 mm  
up to diam  
specially hardened  
cutting edges, front  
and lateral cutting  
action



17-218  
REILL  
175 mm

for soft wire  
up to diam. 2,0 mm  
For hard wire 1,6 mm  
up to diam  
specially hardened  
cutting edges, for  
cutting off wires close  
to the bone



DUROTIP

17-219  
235 mm

for soft wire  
up to diam. 3,0 mm  
For hard wire 2,2 mm  
up to diam

Wire Cutting Pliers, Lateral and Front Cutting Action



pecially hardened cutting edges

17-220  
240 mm

for soft wire up to diam. 2,0 mm  
For hard wire up to diam 1,6 mm



Durotip

17-221  
145 mm

for soft wire up to diam. 1,5 mm  
For hard wire up to diam 1,0 mm



Durotip

17-222  
145 mm

for soft wire up to diam. 2,0 mm  
For hard wire up to diam 1,5 mm



Durotip

17-223  
220 mm

for soft wire up to diam. 3,5 mm  
For hard wire up to diam 2,5 mm

Wire Cutting Pliers



17-224  
320 mm

for soft wire  
up to diam.  
For hard wire  
up to diam

3,0 mm  
3,0 mm



Cutter for cutting off  
KIRSCHNER wires,  
Tibia head screws,  
bolts, pins, up to 3 mm diam.



DUROTIP

17-225  
Cutter for cutting off  
KIRSCHNER wires,  
Tibia head screws,  
bolts, pins, up to 6 mm diam.  
470 mm

Finger Nail Instruments



17-226  
Nail extracting  
forceps  
135 mm



17-227  
Nail extracting  
forceps  
145 mm



17-228  
Finger nail drill  
with 3 drill points

Drill points only



17-231  
Nail splitting  
forceps  
135 mm



17-232  
SYSTRUNK  
Scissors, for splitting  
finger nails  
130 mm



17-233  
Finger ring saw  
150 mm

Spare blade  
17-234

Plaster Shear



17-235  
STILLE-AESCULAP  
260 mm



17-236  
STILLE-AESCULAP  
360 mm

Plaster Spreader, Plaster Breakers



17-237  
HENING  
270 mm



17-238  
MOD.USA  
230 mm



17-239  
290 mm



with removable jaws



17-240 - 17-241  
WOLFF  
17-240 180 mm  
17-241 240 mm  
plaster breakers

## Vacuum Curettes for Aspiration Lipectomy, Suction Instruments

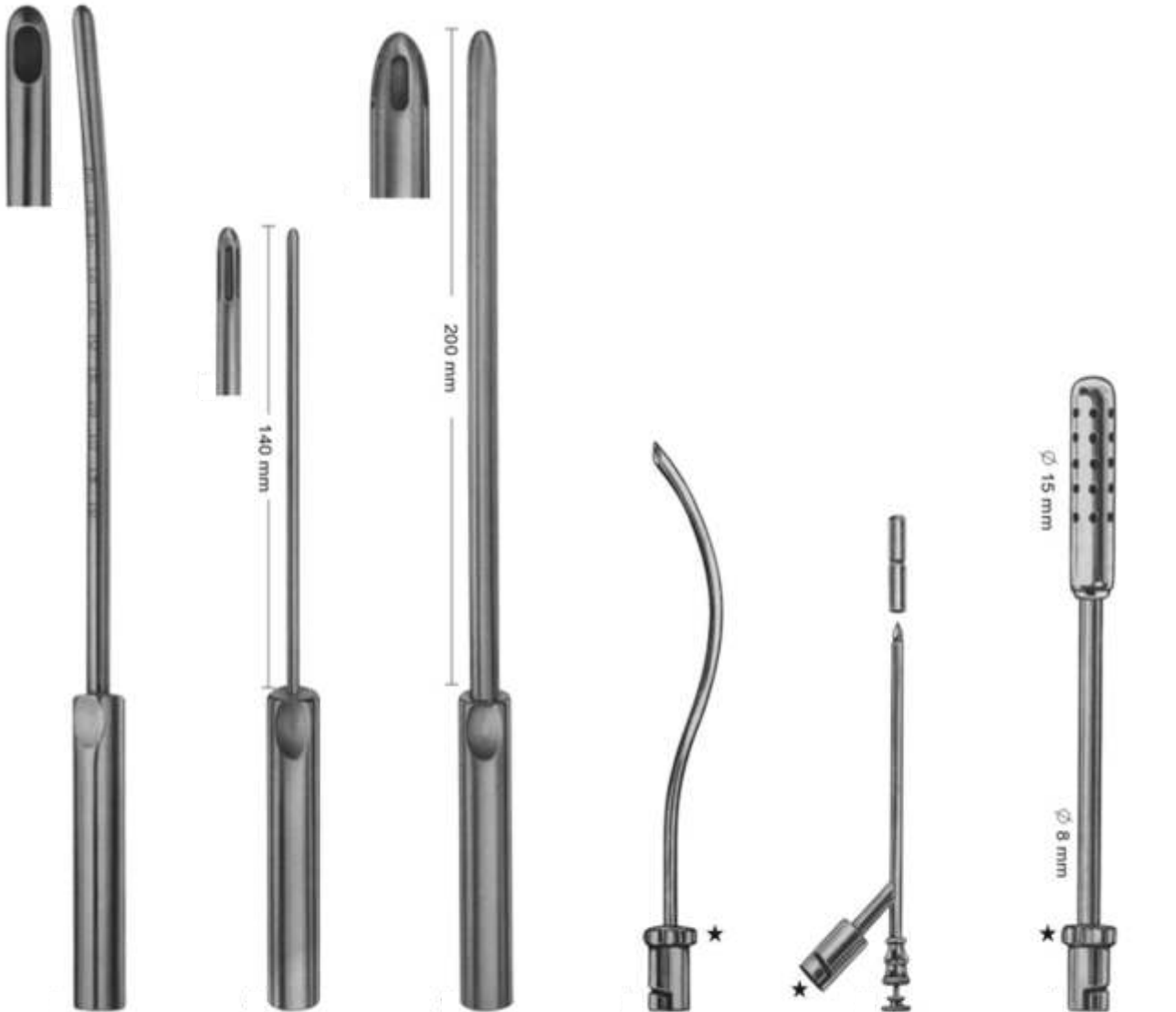

**18-101 - 18-106**  
BIEMER

**18-101** ∅ 4 mm  
**18-102** ∅ 6 mm  
**18-103** ∅ 8 mm  
**18-104** ∅ 10 mm  
**18-105** ∅ 12 mm  
**18-106** ∅ 14 mm

Curettes for aspiration lipectomy, graduated, slightly curved

**18-107 - 18-108**  
BIEMER

**18-107** ∅4 mm  
**18-108** ∅6 mm

Curettes for aspiration lipectomy, with three apertures, slightly curved malleable

**18-109 - 18-111**  
BIEMER

**18-109** ∅8 mm  
**18-110** ∅10 mm  
**18-111** ∅12 mm

Curettes for aspiration lipectomy, with three apertures, slightly curved malleable

**18-112**  
For aspirating fluid from the excretory ducts of large glands and for keeping the operating area clear 170 mm

**18-113**  
Trocar  
For puncturing 150 mm

**18-114**  
For clearing large quantities of fluid 190 mm

## Suction Instruments

**18-115** 150mm  
Suction handle, with vacuum regulator and finger cut-off, brass, mirror-finish chromium-plated



olive  
∅9 mm

**18-116** 170mm  
Suction handle, with hand regulation valve and quick-shutter, brass, mirror-finish chromium-plated



Both suction handles have bayonet fitting olive and can be used for the suction cannulae. ∅9 mm



**18-117**  
Trocar  
For puncturing  
170 mm



**18-118**  
Hollow needle,  
sharp  
150 mm



**18-119**  
double curved  
For general  
surgery  
230 mm



**18-120**  
For tonsillectomy,  
oral and laryngeal  
operations  
190 mm



**18-121**  
For tonsillectomy,  
oral and laryngeal  
operations  
220 mm

★ with bayonet fitting to be used with suction handles (18 - 115 - 18 - -116)

## Suction Instruments

**18-122**  
WULLSTEIN  
Suction tube, conical, silver, olive  
with LUER hub  
160 mm

$\varnothing 1,75$  mm

olive  $\varnothing 3$  mm

**18-123** 1,5 mm  
**18-124** 2,0 mm  
WULLSTEIN  
Suction tube, cylindrical, silver, with  
stylet olive with LUER hub  
160 mm

olive  $\varnothing 5$  mm

Usable length

YASARGIL usable length diam.		YASARGIL usable length diam.	
<b>18-125</b>	130 mm 1,5 mm	<b>18-133</b>	130 mm 2,5 mm
<b>18-126</b>	150 mm 1,5 mm	<b>18-134</b>	150 mm 2,5 mm
<b>18-127</b>	180 mm 1,5 mm	<b>18-135</b>	180 mm 2,5 mm
<b>18-128</b>	220 mm 1,5 mm	<b>18-136</b>	220 mm 2,5 mm
<b>18-129</b>	130 mm 2,0 mm	<b>18-137</b>	130 mm 3,5 mm
<b>18-130</b>	150 mm 2,0 mm	<b>18-138</b>	150 mm 3,5 mm
<b>18-131</b>	180 mm 2,0 mm	<b>18-139</b>	180 mm 3,5 mm
<b>18-132</b>	220 mm 2,0 mm	<b>18-140</b>	220 mm 3,5 mm
		<b>18-141</b>	180 mm 4,5 mm

olive  $\varnothing 6,5-9$  mm with LUER hub

**18-142 - 18-144**  
LANDOLT  
150 MM  
diam  $\varnothing 3$  mm

**18-142** 8 mm / curved  
**18-143** 11mm / curved  
**18-144** 15mm / curved

$\varnothing 3,5$  mm

$\varnothing 2,0$  mm

**18-145** 500 mm  
**18-146** 350 mm  
with rubber tip,  
with LUER hub

olive  $\varnothing 9$  mm

**18-147** 2,0 mm diam  
**18-148** 2,5 mm diam  
**18-149** 3,0 mm diam  
with finger cut-off,  
thumb piece 90° to  
curve, with LUER hub  
250 mm

olive  $\varnothing 6,9$  mm

## Combined Suction and Irrigation Cannulae, Coagulation Suction Cannulae

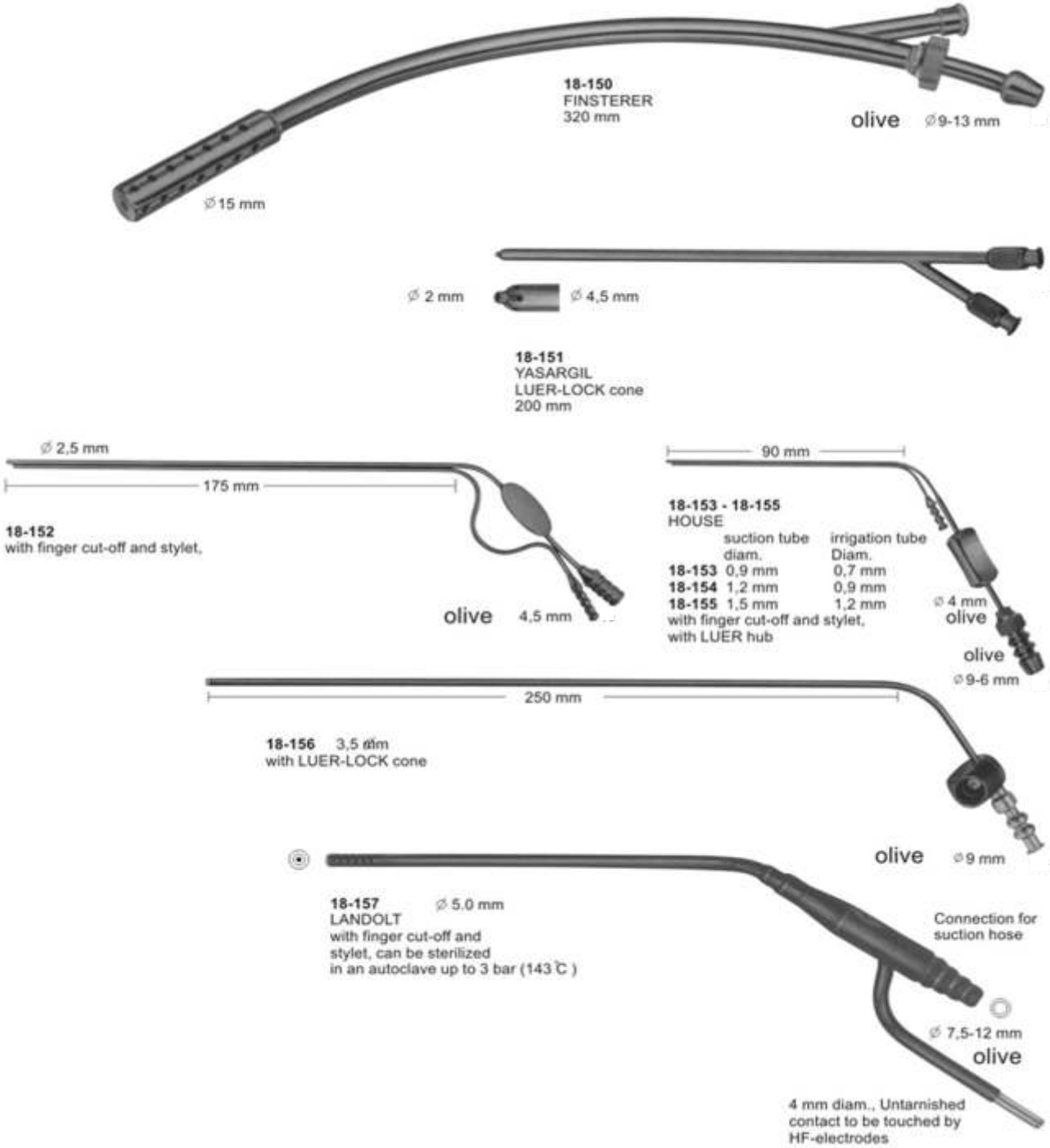

## Suction Instruments

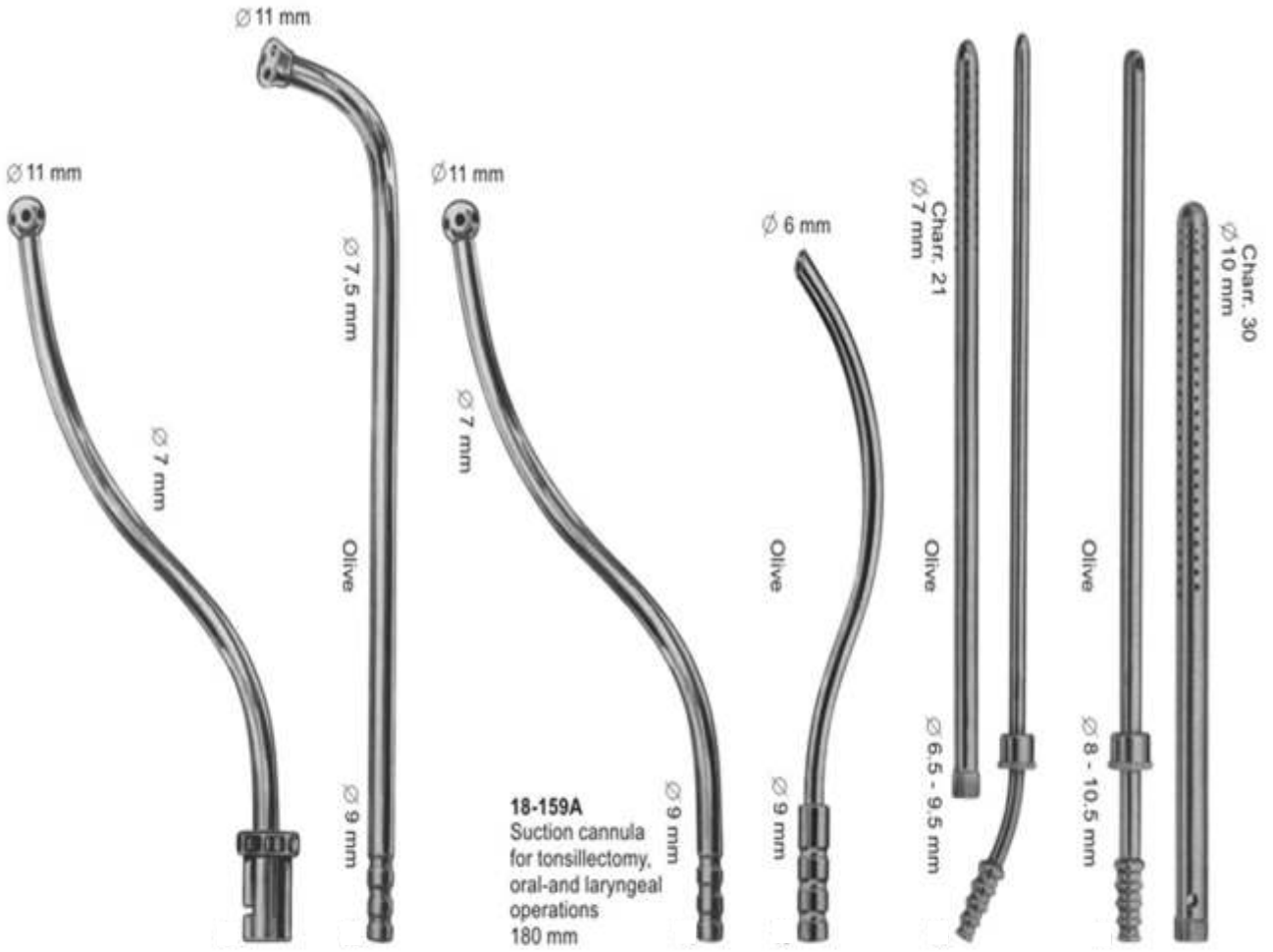

**18-158**  
For tonsillectomy,  
oral-and laryngeal  
operations  
180 mm

**18-159**  
Suction cannula  
for tonsillectomy,  
oral-and laryngeal  
operations  
220 mm

**18-159A**  
Suction cannula  
for tonsillectomy,  
oral-and laryngeal  
operations  
180 mm

**18-160**  
S-shaped blunt cannula  
for aspirating fluid from  
the excretory ducts of  
large glands and for  
keeping the operating  
area clear  
170 mm

**18-161**  
POOL  
Suction cannula,  
with outer tube  
to be screwed of  
225 mm

**18-162**  
POOL  
Suction cannula,  
with outer tube  
to be screwed off  
225 mm

## Suction Instruments

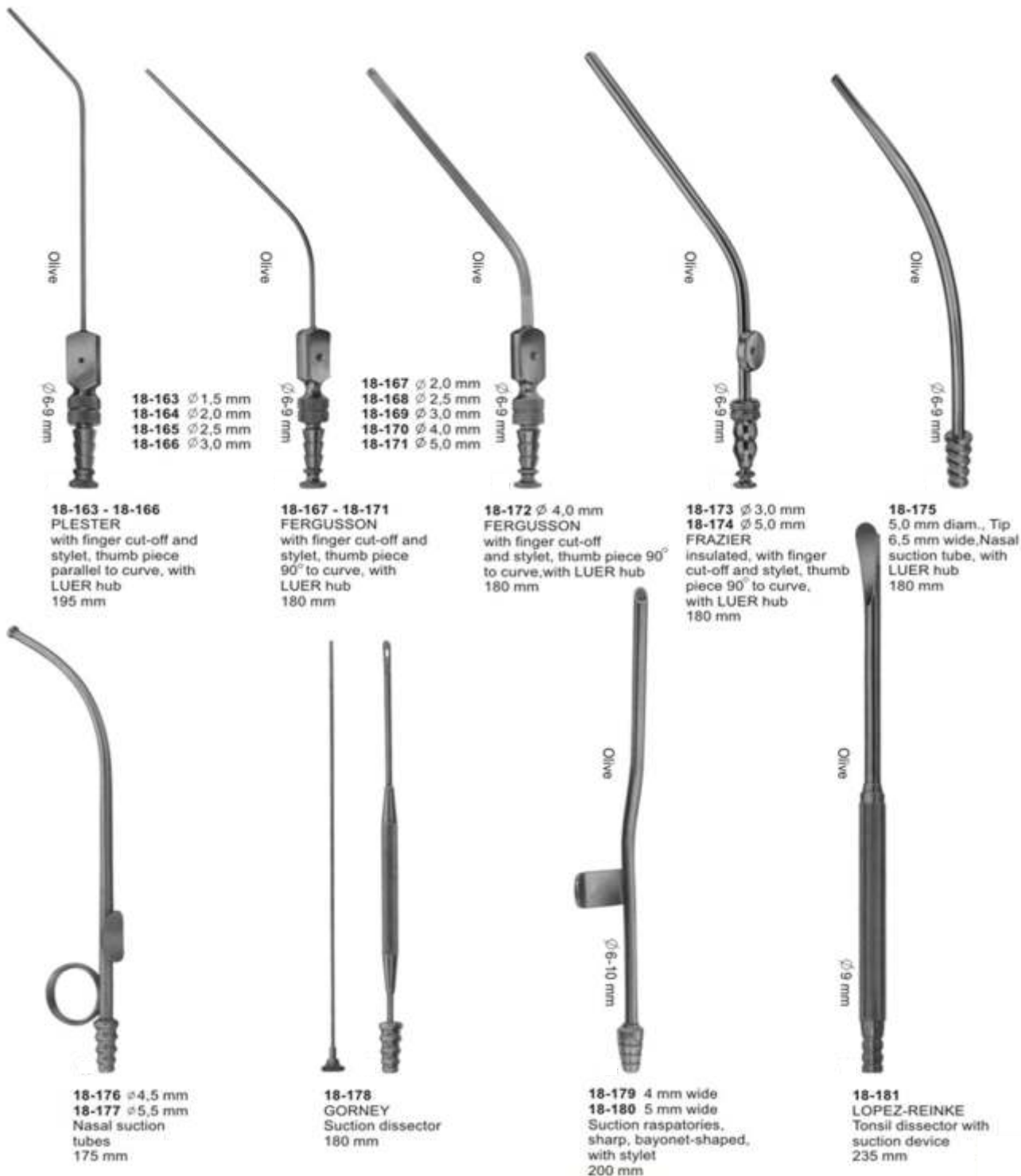

## Dissection Instruments

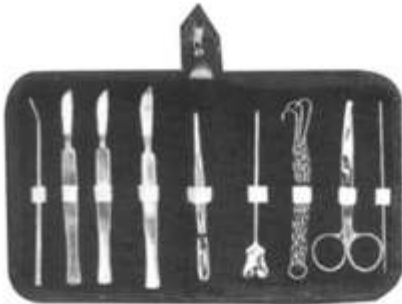

### 18-182

- 1- Blow pipe .
- 2- 3 PCS .scalpel.
- 3- Dissecting forcep 13 cm.
- 4- Grooved director with tounge tie 13 cm.
- 5- Triple chain hook.
- 6- Dressing scissors probe pointed 13 cm.
- 7- Probe double 13 cm.
- 8- Zipper case inside red velvet.

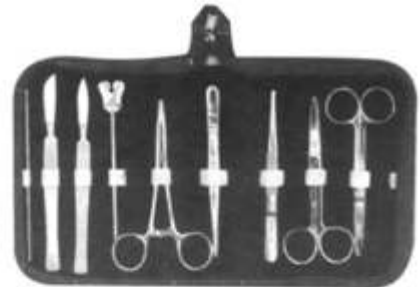

### 18-183

- 1- Probe Double 13 cm
- 2- 2 PCS. Scalpel S. S
- 3- Grooved Director With tongue Tie 13 cm
- 4- Mayo Hegar Needle Holder 13cm
- 5- Dissecting Forcep 13 cm 1x2 Teeth
- 6- Dressing Forcep 13 CMS Serrated.
- 7- Dressing Scissor 13 cm S/B STR.
- 8- Dressing Scissor 13 cm S/B CVD.
- 9- Zipper Case Inside Red Velvet.

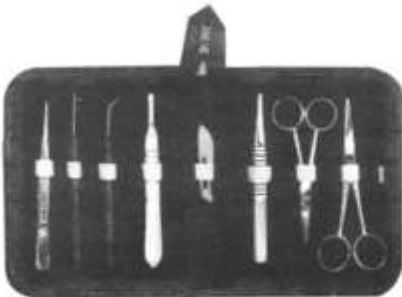

### 18-184

- 1- Dissecting Forcep 11.5 cm Sharp Point.
- 2- Iris Scissor
- 3- B.P Handle No. 4
- 4- Teasing Needle Sharp angular.
- 5- Blade No. 22
- 6- Thumb Forceps T.O.E 13 cm
- 7- Dissecting Scissor STR 11.5 cm
- 8- Dissecting Scissor STR 13 cm
- 9- Zipper case Inside Red Velvet



### 18-185

- 1- Grooved Director with Tongue Tie 14 cm
- 2- Probe Double 14cm
- 3- Mayo Hegar Needle Holder 14 cm
- 4- BP. Handle no.3
- 5- BP. Handle no.4
- 6- Dressing Scissor 14 cm S/B STR.
- 7- Dressing Scissor 14 cm S/B CVD.
- 8- Dressing Forcep 1x2 Teeth 14 cm
- 9- Dressing Forcep Serrated 14 cm



### 18-186

- 1- Probe double 12.5 cm
- 2- Scalpel
- 3- B.P Handle No. 4
- 4- 6 PCS Blade 2 each no. 21, 22, 23
- 5- Dissecting Forcep 12.5 cm
- 6- Dissecting Forcep 11.5 cm sharp Point
- 7- Dissecting Scissor S/B STR 13 cm
- 8- Dissecting Scissor S/S STR 13 cm



### 18-187

- 1- Teasing Needle with Chuck CVD.
- 2- Huber Probe
- 3- Iris Scissor
- 4- Dissecting Forcep Fine 14 cm.
- 5- Dissecting Forcep Fine CVD. 12 cm
- 6- Operating Scissor with Probe 14 cm.
- 7- B.P. Handle no. 4

## Dissection Instruments



### 18-188

- 1- Probe with eye
- 2- Dissecting Forcep cvd fine 12 cm.
- 3- Iris Scissor
- 4- Operating Scissor S/B str 14 cm
- 5- Grooved Director and Tongue tie
- 6- Huber Probe
- 7- Triple Chain Hook
- 8- B.P Handle No. 4
- 9- B.P Handle No. 3
- 10- Teasing Needle with Chuck cvd.
- 11- Teasing Needle with Chuck str.
- 12- Dissecting Forceps Fine 14 cm.

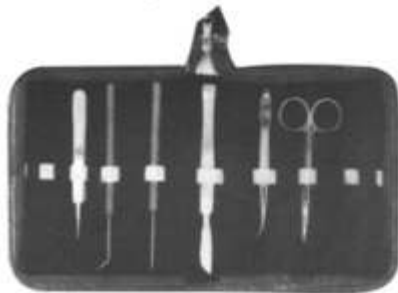

### 18-190

- 1- Iris Scissor STR
- 2- Dissecting Forceps CVD 12 cm.
- 3- Scalpel
- 4- Teasing Needle STR wooden handle.
- 5- Teasing Needle CVD wooden handle.
- 6- Watchmaker fine point.



### 18-192

- 1- Probe double end.
- 2- Grooved director and tongue tie.
- 3- B.P handle no.4
- 4- Operating scissor STR S/b14cm.
- 5- Kelly forceps STR 14cm.
- 6- Dissecting forceps thumb 13cm.

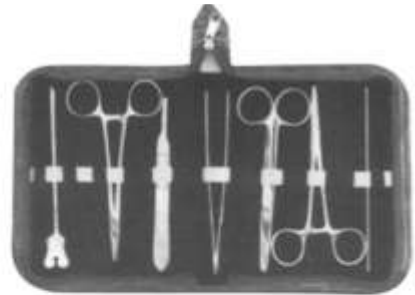

### 18-189

- 1- Grooved Director and Tongue tie.
- 2- Mayo Hearn Needle Holder 14 cm
- 3- B.P Handle No. 4
- 4- Dissecting Forceps Thumb 14 cm.
- 5- Operating Scissor S/B str 14 cm
- 6- Kelly Forcep STR 14 cm.
- 7- Probe Double end

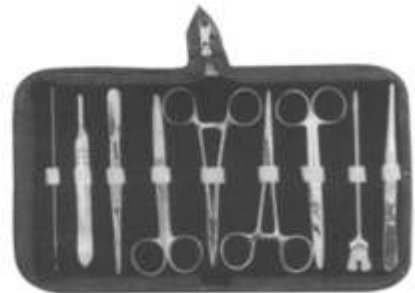

### 18-191

- 1- Probe Double end
- 2- B.P Handle No. 4
- 3- Dissecting Forcep 1x2 Teeth 14 cm.
- 4- Operating Scissor S/B str 14 cm
- 5- Mayo Hearn Needle Holder 14 cm
- 6- Kelly Forcep STR 14 cm.
- 7- Operating Scissor S/B CVD 14 cm
- 8- Grooved Director and Tongue tie
- 9- Dissecting Forceps Thumb 14 cm.



### 18-193

- 1- Dissecting Forceps Thumb 14 cm
- 2- Dissecting Forcep 1x2 Teeth 14 cm.
- 3- B.P Handle No. 3
- 4- Grooved Director and Tongue tie
- 5- Mayo Hearn Needle Holder 14 cm
- 6- Operating Scissor S/B str 14 cm
- 7- Probe Double end
- 8- Kelly Forcep STR 14 cm.

## Dissection Instruments



### 18-194

- 1- Dissecting Forcep Fine 14cm.
- 2- Dissecting Forcep Fine CVD 12cm
- 3- Dissecting Forcep with Pin 14cm.
- 4- Watchmaker Fine point
- 5- Iris scissor STR
- 6- Iris scissor CVD.
- 7- Teasing Needle holder
- 8- Teasing Needle STR.
- 9- B.P. Handle no. 3



### 18-195

- 1- Teasing Needle STR.
- 2- Grooved Director and Tongue Tie.
- 3- Teasing Needle CVD.
- 4- Dissecting Forcep with Pin 12 cm Fine
- 5- Operating Scissor S/B STR 14 cm
- 6- Triple Chain Hook
- 7- Probe with eye
- 8- Probe Double end
- 9- Probe and Hook
- 10- Dissecting Forcep Fine 14 cm
- 11- Iris Scissor
- 12- Huber Probe
- 13- B.P. Handle no.3
- 14- B.P. Handle no.4



### 18-196

- 1- Dissecting forcep fine STR with pin 12cm.
- 2- Iris scissor STR.
- 3- Probe with eye.
- 4- Probe and hook.
- 5- Operating scissor S/B STR 14cm
- 6- Triple chain hook.
- 7- B.P. handle no.4
- 8- Humber probe.
- 9- B.P.handle no.3
- 10- Teasing needle STR plastic handle.
- 11- Teasing needle CVD plastic handle.
- 12- Grooved director and tongue tie.
- 13- Probe double end.



### 18-197

- 1- Dissecting Forceps Thumb 14 cm.
- 2- Dissecting Forcep 1x2 Teeth 14 cm.
- 3- B.P Handle No. 3
- 4- Grooved Director and Tongue tie
- 5- Mayo Hearn Needle Holder 14 cm
- 6- Operating Scissor S/B str 14 cm
- 7- Probe Double end
- 7- Kelly Forcep STR 14 cm.

## Hospital Wares



**19-101 - 115**  
Schimmelbusch

	⌀ x H sizes in mm
<b>19-101</b>	80 x 80
<b>19-102</b>	105 x 120
<b>19-103</b>	140 x 140
<b>19-104</b>	160 x 120
<b>19-105</b>	160 x 150
<b>19-106</b>	190 x 150
<b>19-107</b>	190 x 190
<b>19-108</b>	240 x 160
<b>19-109</b>	240 x 240
<b>19-110</b>	290 x 160
<b>19-111</b>	290 x 240
<b>19-112</b>	340 x 160
<b>19-113</b>	340 x 340
<b>19-114</b>	390 x 190
<b>19-115</b>	390 x 290



**19-116**  
Box  
120 x 65 x 13mm  
(without Bulldog clamps,  
without silicone tape)



**19-117**  
Box with support  
120 x 65 x 13 mm  
(ohne Bulldogklemmen)



**19-118**  
Box with support for  
needle electrodes,  
without instruments



**19-119 - 121**  
50 x 25 x 4,5 mm  
**19-120**  
65 x 42 x 8 mm  
**19-121**  
75 x 25 x 4,5 mm



**19-122**  
⌀ 65mm x 15mm

## Hospital Wares



19-123 - 131

	∅ x H
19-123	30 x 90 mm
19-124	50 x 100 mm
19-125	50 x 130 mm
19-126	50 x 175 mm
19-127	75 x 100 mm
19-128	75 x 130 mm
19-129	75 x 175 mm
19-130	100 x 175 mm
19-131	100 x 200 mm



19-141 - 142

**19-141** Martin Sterilizing Forceps consisting of:  
1 Sterilizing Forceps, curved, 25 cm, without ratchet, with lid for jar  
1 jar with bottom plate (anti-tilt)

**19-142** ditto, with 32 cm long Sterilizing Forceps



19-132 - 139

19-132	165 x 85 x 35 mm
19-133	200 x 100 x 35 mm
19-134	200 x 100 x 50 mm
19-135	230 x 130 x 50 mm
19-136	260 x 150 x 50 mm
19-137	270 x 235 x 50 mm
19-138	300 x 200 x 50 mm
19-139	325 x 275 x 50 mm



**19-140**  
205 x 105 x 35 mm

## Round Metal Boxes and Medicine Cups



19-143 - 148

∅ x H

19-143	75 x 60 mm
19-144	75 x 75 mm
19-145	100 x 60 mm
19-146	100 x 100 mm
19-146A	125 x 80 mm
19-147	125 x 125 mm
19-148	150 x 150 mm



19-149  
25 cc

19-150  
50 cc



19-151  
20 cc  
Medicine Spoon



19-152  
∅ 75 x 12 mm  
Tablet Tray



19-153  
∅ 90 x 90 mm  
Metal Cup



19-154  
∅ 75 x 80 mm  
Sputum Cup



Kidney Dish



19-155 - 157

19-155	170 x 100 x 35 mm
19-156	250 x 140 x 40 mm
19-157	275 x 150 x 45 mm

## Hospital Wares



19-158 - 165



19-166 - 170

	∅ x H	
19-158	40 x 19 mm	0.05L
19-159	61 x 30 mm	0.07L
19-160	80 x 40 mm	0.14L
19-161	116 x 50 mm	0.35L
19-162	128 x 55 mm	0.45L
19-163	147 x 65 mm	0.70L
19-164	167 x 75 mm	1.10L
19-165	187 x 85 mm	1.60L

19-166	116 x 35 mm	0.30L
19-167	128 x 38 mm	0.40L
19-168	147 x 40 mm	0.50L
19-169	157 x 45 mm	0.75L
19-170	187 x 45 mm	1.00L



19-171  
∅ 110 x 28 mm 0.15L



19-172  
100 cc 0.1L



19-173 - 176  
19-173 0.25L  
19-174 0.50L  
19-175 1.00L  
19-176 2.00L



19-177  
235 x 190 x 40 mm



19-178  
∅ 220 x 70 mm

Hospital Wares



19-179  
∅ 50 x 100 mm  
Powder Pot



19-180  
∅ 50 x 75 mm  
Methot With Lid



19-181  
∅ 50 x 75 mm  
Methot Without Lid



19-182



19-183



19-184



19-185 - 186

19-185 ∅ 235 mm  
19-186 ∅ 310 mm

Needle Cases



**19-187**  
Sauerbruch  
210 x 125 x 17 mm



**19-188**  
Sauerbruch  
210 x 125 x 17 mm



**19-189**  
150 x 95 x 13 mm



**19-190**  
150 x 95 x 13 mm



**19-191**  
150 x 95 x 13 mm



**19-192**  
150 x 95 x 13 mm



**19-193**  
150 x 95 x 13 mm



**19-194**  
150 x 95 x 13 mm



**19-195**  
150 x 95 x 11 mm

## Storing Cases



19-199 - 209

<b>19-199</b>	230 x 130 x 50 mm
<b>19-200</b>	260 x 150 x 50 mm
<b>19-201</b>	275 x 235 x 50 mm
<b>19-202</b>	300 x 200 x 50 mm
<b>19-203</b>	325 x 275 x 50 mm
<b>19-204</b>	420 x 175 x 50 mm
<b>19-205</b>	230 x 130 x 75 mm
<b>19-206</b>	260 x 150 x 75 mm
<b>19-207</b>	300 x 200 x 75 mm
<b>19-208</b>	325 x 275 x 75 mm
<b>19-209</b>	420 x 175 x 75 mm



**19-196**  
Deponette  
245 x 135 x 35mm



**19-197**  
Deponette  
245 x 135 x 50mm



**19-198**  
Deponette  
245 x 135 x 60mm

Sterilizing Baskets / Trays



19-210 480 x 250 x 50 mm  
19-211 520 x 250 x 75 mm  
19-212 520 x 250 x 100 mm

19-210 - 212



19-219  
(60 x 30 x 15 cm)  
Nominal dimensions



19-213 - 218

19-213 240 x 240 x 50 mm  
19-214 240 x 240 x 80 mm  
19-215 240 x 240 x 100 mm  
19-216 480 x 260 x 50 mm  
19-217 520 x 260 x 80 mm  
19-218 520 x 260 x 100 mm

Scissors with Tungsten Carbide Inserts

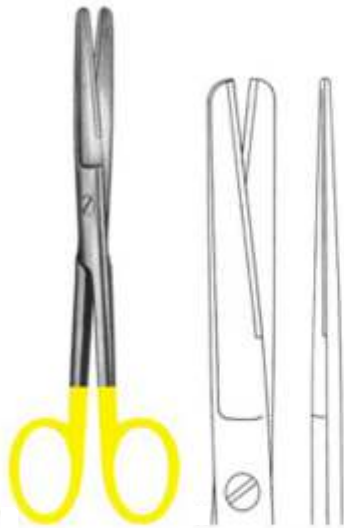

26-101  
Standard

14,5cm  
16,5cm  
18,5cm



26-102  
Standard

14,5cm  
16,5cm  
18,5cm



26-103  
Standard

14,5cm  
16,5cm  
18,5cm



26-104  
Standard

14,5cm  
16,5cm  
18,5cm



26-105  
Standard

14,5cm  
16,5cm  
18,5cm



26-106  
Standard

14,5cm  
16,5cm  
18,5cm

Scissors with Tungsten Carbide Inserts



16cm

26-107  
Mayo-Lexer

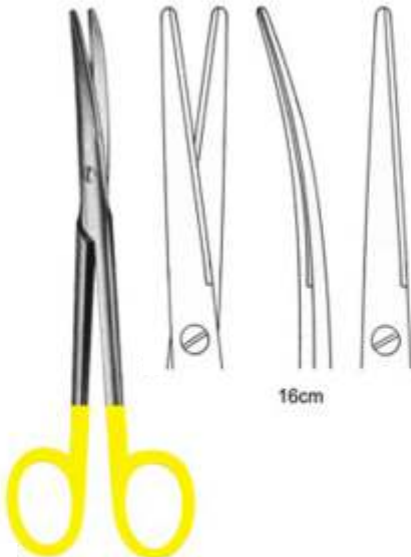

16cm

26-108  
Mayo-Lexer



16cm  
21cm

26-109  
Lexer

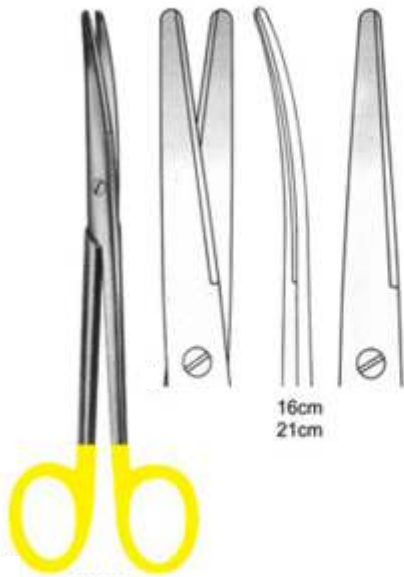

16cm  
21cm

26-110  
Lexer

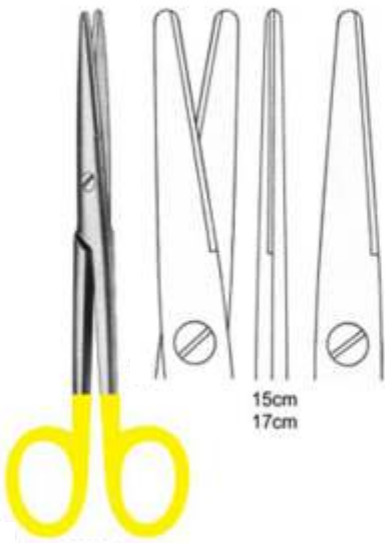

15cm  
17cm

26-111  
Mayo-Stille

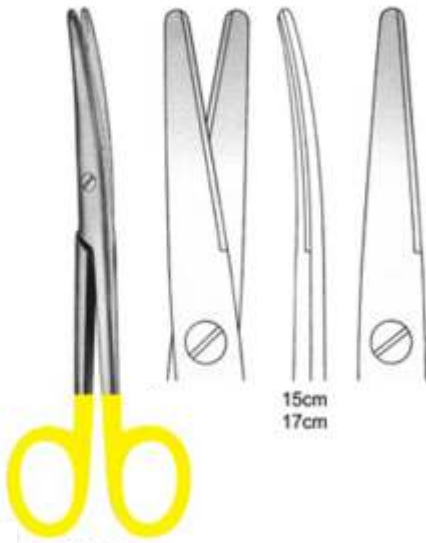

15cm  
17cm

26-112  
Mayo-Stille

Scissors with Tungsten Carbide Inserts



26-113  
Metzenbaum

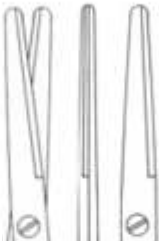

18cm 11,5cm  
20cm 14,5cm  
28cm 23,5cm  
30cm 25,5cm



26-114  
Metzenbaum



11,5cm 14,5cm  
23cm 25cm



26-115  
Metzenbaum

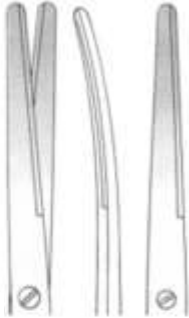

18cm 20cm  
28cm 30cm



26-116  
Metzenbaum-Fino



14cm 18cm 20cm  
23cm 25cm 28cm



26-117  
Metzenbaum-Fino



14cm 18cm 20cm  
23cm 25cm 28cm



26-118  
Metzenbaum-Fino



14cm 18cm  
20cm 23cm

Scissors with Tungsten Carbide Inserts

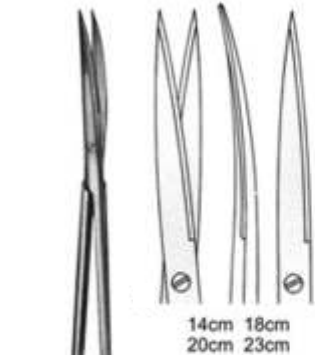

26-119  
Metzenbaum-Fino

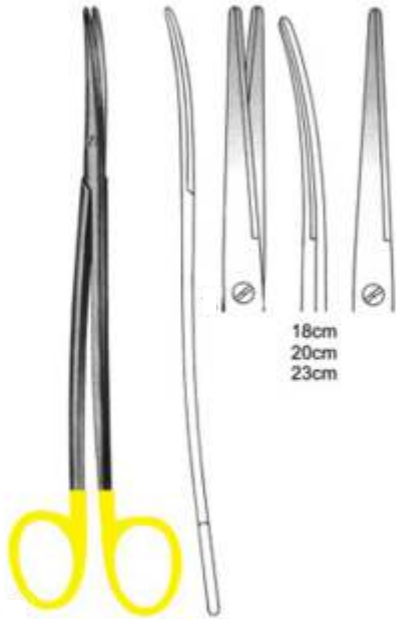

26-120  
Metzenbaum-Fino

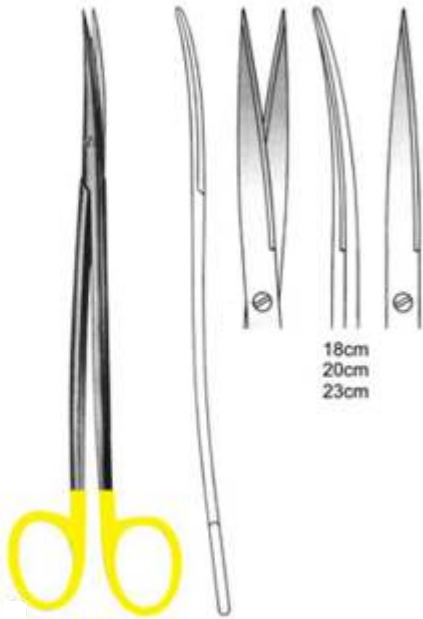

26-121  
Metzenbaum-Fino

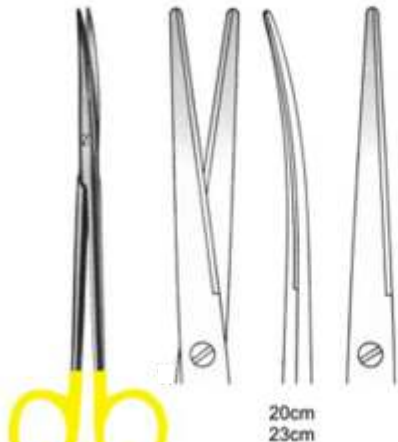

26-122  
Metzenbaum



26-123  
Mayo

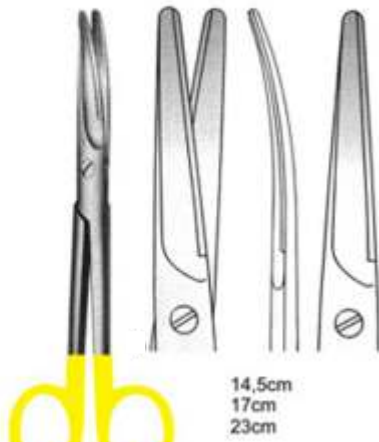

26-124  
Mayo

Scissors with Tungsten Carbide Inserts



26-125  
Parametrium



26-126  
Mayo-Harrington



26-127  
Sims

Scissors with Tungsten Carbide Inserts

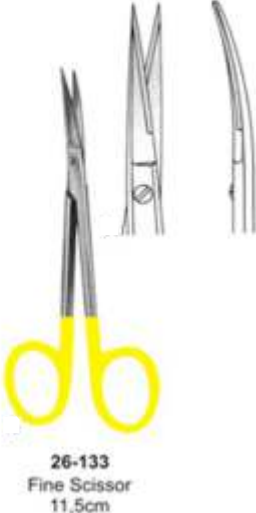

Scissors & Dissecting Forceps with Tungsten Carbide Inserts

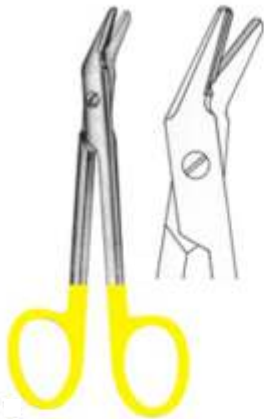

26-136  
Universal  
12cm



26-137  
Ligature Scissors  
1 Black & 1 Goldplated ring



26-138  
Adson



26-139  
Cushing  
17.5cm



26-140  
Cushing  
18cm



26-141  
Cushing-Taylor  
18cm



26-142  
Dissecting Forceps  
15cm



26-143  
Semken  
15cm

Dissecting Forceps and Needle Holders with

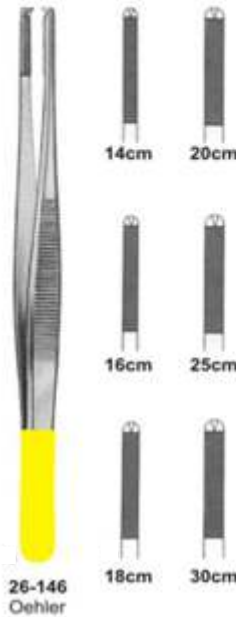
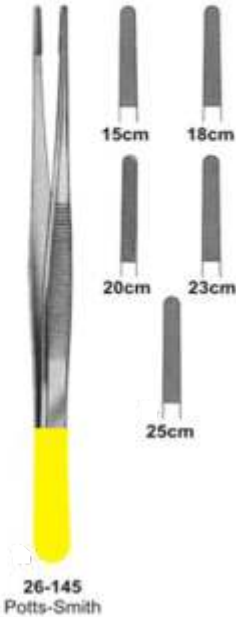

Needle holders with Tungsten Carbide Inserts



26-152  
Arruga  
16cm



26-153  
Castroviejo  
13cm



26-154  
Hegar  
20cm 24cm



26-155  
Halsey  
13cm 15cm



26-156  
Mayo-Hegar  
16cm 18cm 20cm  
24cm 26cm 30cm



26-157  
De-Bakey  
18cm 20cm 23cm  
26cm 31cm 37cm



26-158  
Hegar-Vascular  
14cm 18cm  
20cm 23cm

Needle holders with Tungsten Carbide Inserts



26-159  
Bozemann-Wertheim  
20cm 24cm 26cm



26-160  
Stralte  
22cm 23cm



26-161  
Ryder  
13cm 15cm 18cm  
20cm 23cm 26cm



26-162  
Ryder-Vascular  
13cm 15cm 18cm  
20cm 23cm 26cm



26-163  
Martin  
15cm 17cm 20cm



26-164  
Sarot  
18cm 20cm 26cm

Needle holders with Tungsten Carbide Inserts



Needle holders with Tungsten Carbide Inserts



26-172  
Mathieu-Ryder  
17cm  
20cm 24cm



26-173  
Lichtenberg  
20cm



26-174  
Langhals  
20cm 25cm



26-175  
Lichtenberg  
20cm 25cm



26-176  
Luehty-Beck  
20cm 25cm



26-177  
Luehty-Beck  
20cm 25cm



26-178  
Langebeck  
18cm  
20cm 23cm

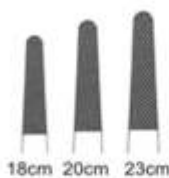

26-179  
Langebeck-beck  
18cm  
20cm 23cm

Wire Cutting Plier With T.C. Inserts



26-180  
TOENNIS  
Elastic pattern for  
dura-or intestinal suture  
180 mm



26-181  
Cutting Plier  
12 cm

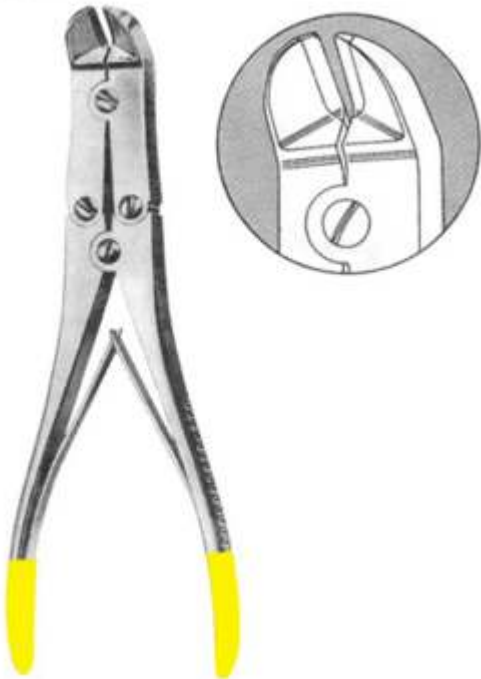

26-182  
MULLAR CLAUS  
22 cm

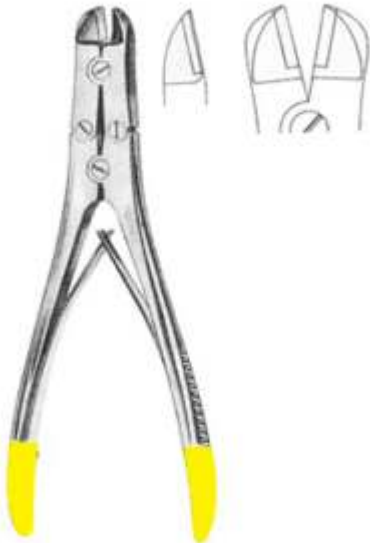

26-183  
Plier  
17.5 cm